

IX Series

Master Station

IX-MV7-HW

IX-MV7-HB

IX-MV7-W

IX-MV7-B

Operation Manual

Software version 2.00 or later

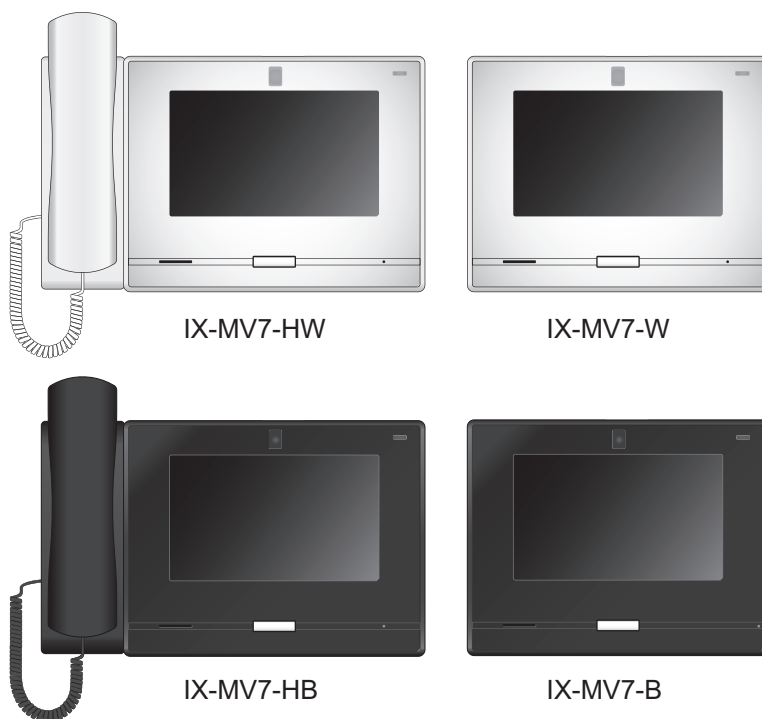





Important

- Read this "Operation Manual" prior to use to ensure safe and correct operation. Keep this in a safe place for future reference.
- The illustrations used in this manual may differ from the actual ones.







Literature information









The important information concerning correct operation and what you should observe is marked with the following symbols.

 Warning	This symbol means that operating the station incorrectly, or ignoring these precautions may cause severe injury or death.
 Caution	This symbol means that operating the station incorrectly, or destination. Ignoring these precautions may cause severe injury or property damage.
 Important	This symbol is intended to alert the user to important instruction. Please read and understand before proceeding.
 Note	Indicates tips and additional information for operation.

- Terms and button names displayed on the station and PC screens are indicated as [XXXX].
- Page reference are shown as "[Title \(→ page XX\)](#)", ([→ page XX](#)), or [page XX](#).
- The illustrations and images used in this manual may differ from the actual items.
- In this manual, Video Door Stations and Door Stations without cameras are referred to collectively as "Audio Door Station."
- "Video Door Station" is used when describing the operation and explanation of Video Door Stations.
- VoIP Phones and IX system stations are referred to collectively as "Stations."

Precautions

 Warning		<p>This symbol means that operating the device incorrectly ignoring these precautions may cause severe injury or death.</p>
 <p>Do not disassemble or modify the station. This may result in fire or electrical shock.</p>	 <p>Keep the station away from liquid. This may result in fire or electrical shock.</p>	 <p>If there is smoke, abnormal odor, abnormal sound, or if the station is damaged, immediately disconnect the LAN cable from the station. This may result in fire or electrical shock.</p>
 <p>Keep the station away from flammable materials. If this happens, remove the LAN cable from the station. This may result in fire or electrical shock.</p>	 <p>Do not, under any circumstances, open the station. Voltage within some internal components may cause electrical shock.</p>	

 Caution		<p>Negligence could result in injury to people or damage to property.</p>
 <p>Do not attempt to cover, insulate, or coat the station in any way. This may result in fire or malfunction.</p>	 <p>Do not puncture the LCD screen with a sharp object. If the screen is punctured, it may result in injury.</p>	
 <p>Do not install the station in a place subject to frequent vibration or impact. This may result in injury.</p>	 <p>When testing chime volume and ringtone volume, do not hold the handset close to your ear. May cause harm to the ear if a sudden loud noise is emitted.</p>	
 <p>Do not apply excess pressure to the LCD screen. If the screen is punctured it may result in injury.</p>	 <p>Do not put your ear close to the speaker when using the station. May cause harm to the ear if a sudden loud noise is emitted.</p>	
 <p>If the LCD is punctured, do not touch the liquid crystal inside. Inflammation could result.</p> <ul style="list-style-type: none"> • If liquid crystal is ingested, immediately gargle with water and consult your doctor. • If contact should occur, flush or rinse area with water thoroughly and consult your doctor. 		

Precautions on operation

Requests

- Keep the unit more than 1m (3.3') away from radio or TV set.
- Keep the station at least 20 cm (7-7/8") away from wireless devices such as wireless routers, or cordless telephones. These devices may cause the image or sound distortion.
- Talk within 30cm (12") or less from the station. If you stand too far away, it may be difficult for the other person to hear the communication.
- Installing the device in the following locations could cause malfunction:
 - Locations under direct sunlight
 - Locations near heating equipment
 - Locations subject to liquid, iron filings, dust, oil, or chemicals
 - Locations subject to moisture and humidity extremes
 - Locations where the temperature is quite low
 - Locations subject to steam or oil smoke
 - Sulphurous environments
 - Locations close to the sea or directly exposed to sea breeze
- When installing or using the station, give consideration to the privacy rights of subjects, as it is the responsibility of the system owner to post signs or warnings in accordance with local ordinances.
- In order to prevent sensitive information stored in the station from being lost or stolen, it is the customer's responsibility to delete settings, recorded video/audio, and other information stored in the station, when discarding, transferring, or returning the station. Refer to the relevant page of this document for information on how to clear information.
- As to other 3rd party devices (such as sensor, detectors, door releases) used with this system, comply with the Specifications and Warranty conditions that the manufacturers or vendors present.
- Be sure to receive and store the setting file from the person who configured the system. If the setting file is lost, recovery may not be possible and creating a new setting file may be required.
- Do not install the station under direct sunlight. If it is necessary, shield the station from sunlight or the screen may be difficult to view.

Notices

- Aiphone is not to be held responsible for any and all damages resulting from content or specifications of this product.
- Aiphone is not to be held responsible for any and all damages resulting from malfunctions, defects, or misuse of this product.
- This station cannot be used during power outages.
- If the station is used in areas where there are business-use wireless devices such as a transceiver or mobile phones, it may cause malfunction.
- This station is designed for indoor use only. Do not use at outdoor locations.
- This station is not meant to protect lives or property. Aiphone is not to be held responsible for any and all resulting serious accidents, disaster accidents, or physical damage.
- It must be noted in advance that the LCD panel inevitably will have a very small portion of its picture elements always lit or not lit it at all. This is not considered a station malfunction.
- The handset and the station may become slightly warm. However, this is not a malfunction.
- Hands-free calls are a method of automatically switching between the transmitter and receiver so that the louder of the two is prioritized, making it audible by the quieter of the two. If the surrounding area is loud, the call may be interrupted, making it difficult to respond.
- During communication, the voice may not come through clearly when speaking before the other party has finished talking. Communication will proceed smoothly when waiting until the other party has finished before speaking.
- The noise reduction function may determine that certain tones are noise and cut transmission of those tones. This is not a malfunction.
- Warm-color lighting shining on the door station may change the tint of the image on the screen.
- If light enters the camera, the brightness of the LCD could flicker, while the subject of the camera could become darker due to the backlight. This is not a malfunction.
- When wall-mounted, the top of the station may darken. This does not indicate a malfunction.
- The background or colors could differ from the actual image if a striped pattern or other fine pattern is displayed. This is not a malfunction.
- If light from an LED light, fluorescent light, etc., enters the camera on the Video Door Station or other product, black stripes could appear on the LCD, the screen could flicker, or the colors could change. This is not a malfunction.
- When outside temperature lowers sharply after rainfall, etc., the inside of the camera may fog up slightly, causing a blurry images, but this is not a malfunction. Normal operation will be restored when moisture evaporates.
- Aiphone assumes no responsibility for corruption of saved information (such as changes to or deletion of saved information). Be aware of this in advance.
- Station maybe unoperatable while updating the system settings.
- If communication becomes congested or calls are made from multiple Video Door Stations in the system, the audio could drop, become delayed, or otherwise not operate normally.
- Aiphone assume no responsibility for damages as a result of delayed or unusable services, which were due to failures in network equipment, communication services by Internet and cellular phone companies, line interruptions, communication failures, or inaccuracies or omissions in transmission unit.
- Aiphone is not to be held responsible for any damages resulting from customer PINs or other transmitted information being leaked due to interception, unauthorized access, or other reasons along the communication path through the Internet.
- It is the customer's responsibility to ensure that their computer is secure. Aiphone is not liable for security failures.
- Available functions and services are limited according to the specifications of the installed system.
- The illustrations used in this manual may differ from the actual ones.
- Using a fluorescent light could periodically alter the color of the screen (color rolling). This is not a malfunction.
- If there is no power for 30 minutes or more, the date and time return to default.

Table of contents

1 Precautions

Literature information	2
Literature information	2
Precautions	3
Precautions	3
Precautions on operation	4

2 Before Using

Part Names	9
Part Names	9
Status Indicators	11
Status Indicators	11
Camera View Range and Mounting Position	13
Camera View Range and Mounting Position	13
User Interface	14
User Interface	14
Entering Text	20
Entering Text	20
Answering a call	21
Answering a call	21
Setting the date and time	25
Setting the date and time	25
About microSD card	27
About microSD card	27
Inserting/Removing microSD Cards	28

3 How to use

Searching for Stations (VoIP Phones) and Groups	30
Selecting / Choosing / Calling by Number	30
Specify a station or group using the address book.	31
Searching for stations	32
Call / Recording History	33
Reviewing Call History	33
History Screen	34
Placing / Answering a Call	35
Placing a Call	35
Calling a Group	37
Use an external device to place a call	39
Answering a call	41
Page / Receive paging	43
Paging a group	43

Table of contents

Paging all stations	45
Message Paging a group	47
Message Paging all stations	50
Contact Input Page	53
Receiving a page	54
Monitoring	56
Monitoring a door station	56
Scan Monitoring	58
Using Speed Dial Buttons	60
Using Speed Dial Buttons	60
Checking recordings	61
Viewing Recordings	61
Understanding the Playback Screen.	63
Play Video/Audio Recordings using a PC	64
Transfer	65
Transfer calls (during communication)	65
Absent Transfer	68
Other Transfer Options	70
Operations while placing a call, in communication, paging and monitoring	71
Unlocking a door	71
Placing a call on hold	73
Selecting a station to answer	74
Recording Video / Audio	75
Fixing the Capture Area	76
Adjusting video to enhance visibility	77
Adjusting Screen Brightness	78
Adjusting speaker volume	79
Adjusting microphone volume	80
Adjusting Ringtone Volume	81
Checking the System	82
Using Line Supervision	82
Performing Device Check	84
Confirming Station Information	86
Other functions	88
Configuring the station sound a tone on a schedule	88
Playing the Communication Audio Messages automatically	89
Sending an email	90

4 Settings and Adjustments

About the settings	91
Settings	91
Configuring on the station	99
Before Configuring the Station	99
Station Settings	101
Call Settings	104

Table of contents

Communication Settings	113
Transfer Settings	114
Paging Settings	125
Monitor Settings	126
Record Settings	128
Chime Settings	130
Relay Output Settings (administrator privileges only)	136
Volume Settings	145
Speed Dial Settings	147
Supervision Settings (administrator privileges only)	158
Factory Reset	160
Station programming	162
Station Programming	162
Station Information	167
Network Settings	170
System Information	172
Call Settings	174
Option Input / Relay Output Settings	180
Paging Settings	182
Function Settings	184
Transfer Settings	204
Station Settings	211
Maintenance	225

5 Other

Appendix	226
Specifications	226
Maintenance	226
Notice regarding the software	227
Notice regarding the software	227
FOR PROPER USE OF THE STATION	231
REGULATIONS	231
WARRANTY	232

Part Names

Master Station IX-MV7-HW, IX-MV7-HB, IX-MV7-W, and IX-MV7-B

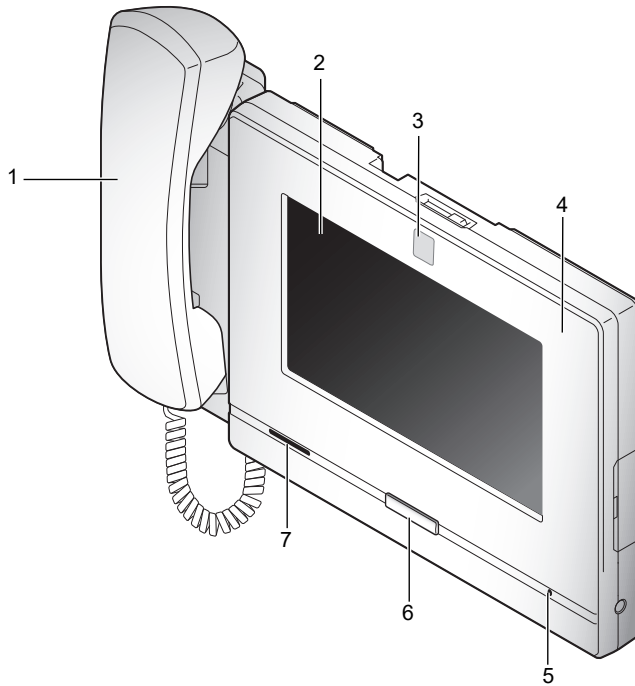

Right Side

Top

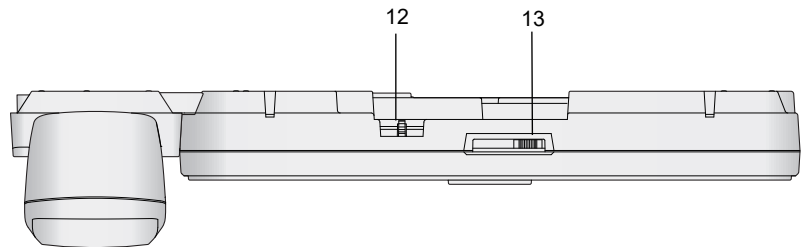
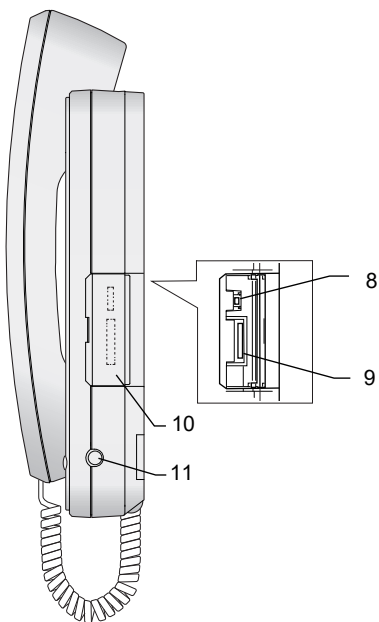

Number	Name & description
1	Handset (IX-MV7-HW and IX-MV7-HB only)
2	Touchscreen LCD
3	Camera
4	Status indicator (Orange/Blue) Shows the status of this station. (→page 11)
5	Microphone
6	Home button Press this to display the Home Screen. Pressing this while the Home Screen is displayed will switch the station into standby mode. (→page 14)
7	Speaker
8	Reset button To be used by personnel only. Do not press.
9	microSD card slot Used for inserting or removing a microSD card (sold separately). (→page 27)
10	microSD card slot cover
11	3.5 mm 4-pole stereo mini jack (CTIA standard) Used to connect a 3rd party headset. (→page 24)
12	Camera angle adjustment lever Used to adjust the angle of the camera vertically. (→page 13)
13	Camera privacy cover lever Used to hide the camera.

Status Indicators

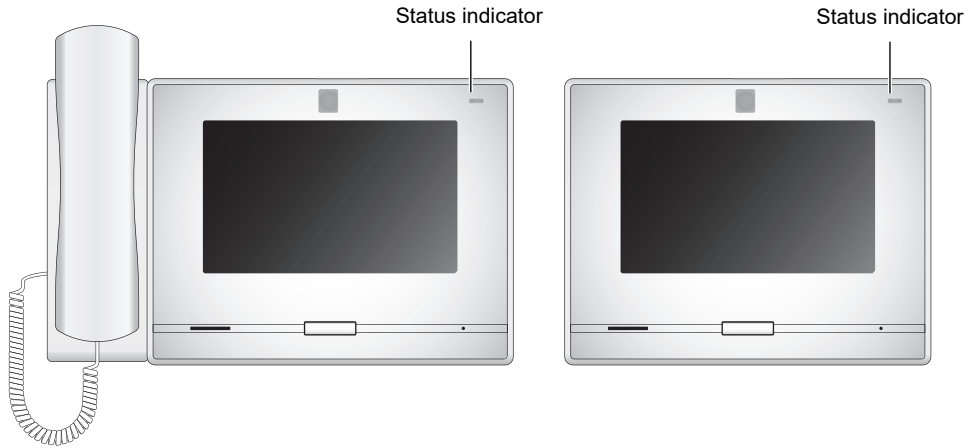

IX-MV7-HB/ IX-MV7-HW

IX-MV7-B/ IX-MV7-W

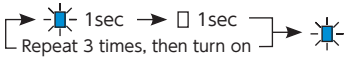
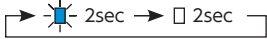
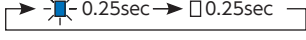
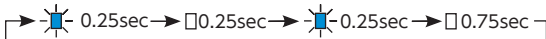

☀: On, □ : Off

Name	Status (pattern)		Description
Status indicator	Orange light	☀	Setting transfer
	Orange flashing	☀ 0.75 sec → □ 0.75 sec	Booting
		☀ 0.25 sec → □ 0.25 sec	Device error Startup error
		☀ 0.5 sec → □ 4 sec	Communication failure Line supervision and device check error
		☀ 1 sec → □ 0.25 sec → ☀ 0.25 sec → □ 0.25 sec → ☀ 0.25 sec → □ 0.25 sec	Firmware version updating
		☀ 1sec → □ 0.25sec → ☀ 0.25sec → □ 0.25sec	Initializing

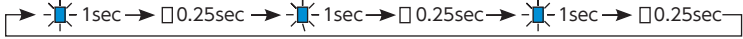
Name	Status (pattern)	Description	
Status indicator	Blue light 	Standby (Depends on setting)	
	Blue flashing	 Repeat 3 times, then turn on	Calling destination busy
			Incoming Page
			Outgoing Call Paging Monitoring
			Incoming Call
			Missed Call Door Release* ¹
			Receiving an event notification from a network camera

*1 This flashes when the door release contact is triggered.
If the door release timeout is set to 3 seconds or less, it will flash at a 3 second interval.

Camera View Range and Mounting Position

Camera view adjustment

The camera angle can be adjusted downward (0 to -20 degrees) using the camera angle adjustment lever. Set the angle to the optimal position.

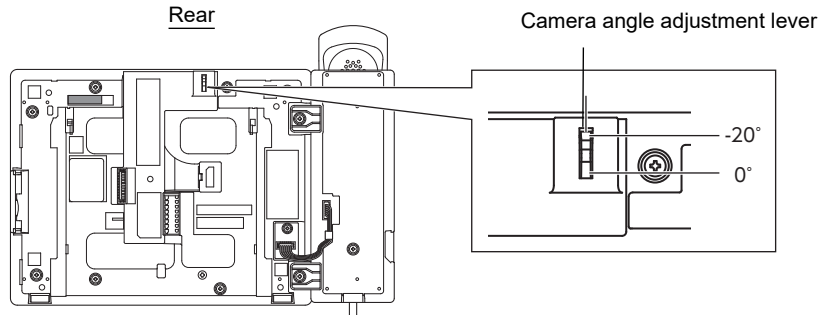

Camera view range

The camera range as illustrated is only an approximate indication and may vary according to the environment.

- Example: Installed on table

Installed on a flat desktop (with desktop stand at 45°, camera angle at the lowest position (-20°))

Vertical

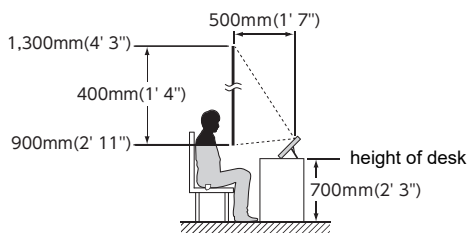

Horizontal

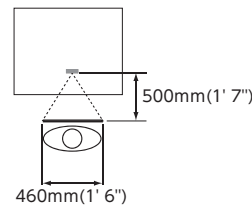

- Example: installed as a reception station

Installed on a flat desktop (with desktop stand at 30°, camera angle at the lowest position (-20°))

Vertical

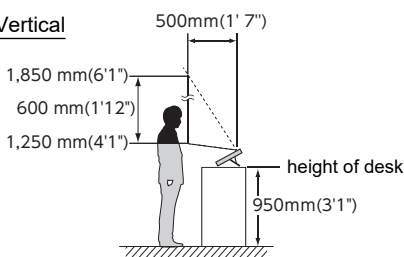

- Example: Installed on a wall

Vertical

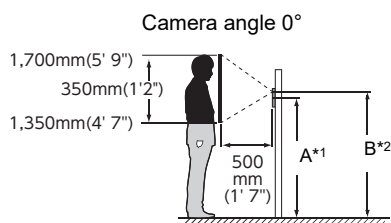

*1 A: Center of device 1,500 mm (4' 11")

*2 B: Camera position 1,575.5 mm (5' 2")

Camera angle -20°

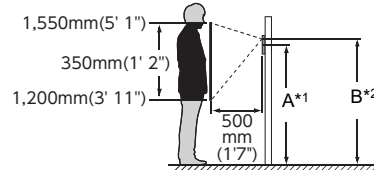

Horizontal

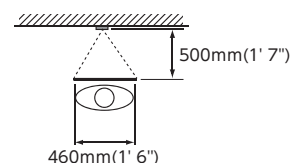

User Interface

When the LCD display is OFF, the device is in standby mode. If the station is inactive for approximately one minute or if the [HOME] button is pressed while the display is active, the station will enter standby mode.

Note

Screen display varies depends on the settings.

Home Screen

Tap the LCD display when the station is in standby mode or press the [HOME] button to display the Home Screen. Two types of Home Screens are available. Select the screen type during setup. ([→page 196](#))

Home Screen 1



Home Screen 2

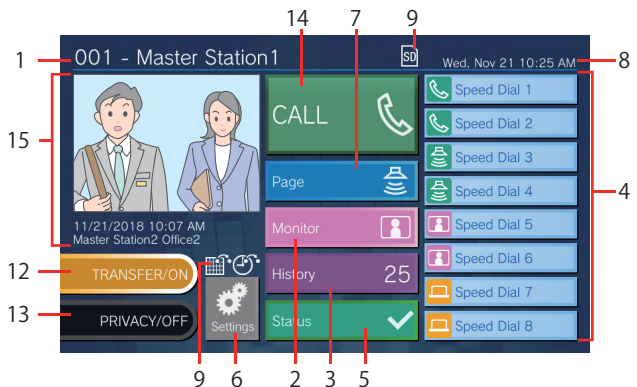

Number	Name	Description
1	Station information	The Station Number and Station Name of this station.
2	Monitor	Tap to monitor the specified station (→page 56 to page 59).
3	History	Tap to check Incoming Calls, Outgoing Calls, Missed Calls, and Recordings. (→page 33)
4	Favorites	Tap to display the speed dial buttons. (→page 60)
5	Status	Tap to check Line Supervision, Device Check, Station Information, and Network Information (→ page 82 to page 87).
6	Settings	Tap to configure settings. (→page 99)
7	Page	Tap to send a page (→page 43 to page 52).
8	Date and time	Indicates the current date, day of the week, and time.
9	Various icons	<ul style="list-style-type: none"> : This is displayed while schedule transfer is configured. : This is displayed while delay transfer is configured. : This is displayed when a microSD card is inserted. Tap it to remove.
10	Dial	Tap to enter a station number or group number using the keypad and place a call. (→page 30)
11	Address Book	Tap to display a list of stations to call. (→page 31)
12	Transfer ON/Transfer OFF	Tap to turn absent transfer ON/OFF. (→page 114)

Number	Name	Description
13	Privacy ON/Privacy OFF	Tap this to turn the privacy function ON/OFF. (The privacy function turns the microphone and image from this station off when a call is answered with Auto Answer, so that audio and video are not sent to the other party.)
14	Call	Tap this to place a call using the address book. (→page 31)
15	Missed Incoming Call History	Shows recent incoming call history and recorded videos. If no videos have been recorded, the recorded video image will not be displayed.

Incoming Call Screen



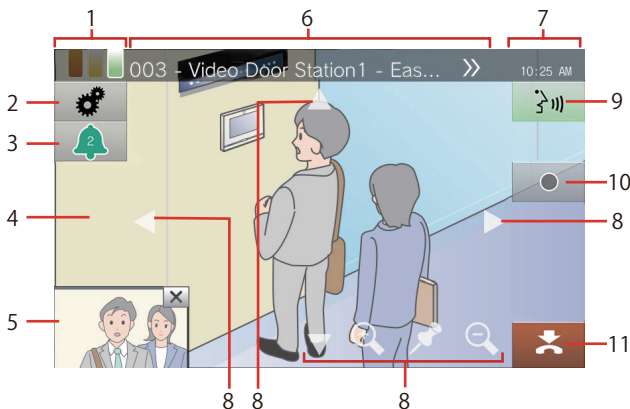

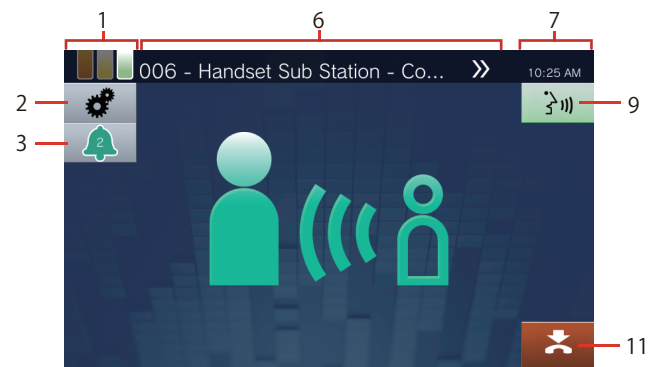

When receiving a call from a video station



When receiving a call from an audio station



Number	Name	Description
1	Priority	Indicates the priority level of the incoming call and page. : Urgent, : Priority, : Normal
2	Settings	The following items can be adjusted. (→page 76) <ul style="list-style-type: none"> : Zoom lock : Backlight compensation and nighttime sensitivity correction for video : Screen brightness : Receive volume : Mic volume : Ringtone
3	Number of incoming calls and priority	Shows the number of incoming calls and the priority. Tap to display the calling stations in a list and select a station to answer. (→page 74) : Urgent, : Priority, : Normal
4	Primary video display area	Shows video from the calling station or associated network camera. Select the camera to display. (→page 224)
5	Secondary video display area	Displays if a network camera is associated with the calling station, and the station has a camera. A different video will be displayed from what is displayed in the primary video display area. Tapping the screen switches between the primary video display area and the secondary video display area.
6	Calling station	Shows the station number, station name (Option Input name), and location of the calling station. If a network camera is associated with the calling station, the name of the network camera will also be displayed (the text may not appear correctly depending on the setting language.) If the text does not appear correctly, tap to scroll the display.
7	Time	Indicates the current time.

Number	Name	Description
8	Screen control icon	<p>Tap these to change the visible display area of the screen. This cannot be done if the icon is not displayed. (→page 76)</p> <p> : Move the screen up.</p> <p> : Move the screen down.</p> <p> : Move the screen left.</p> <p> : Move the screen right.</p> <p> : Zoom in on the screen.</p> <p> : Zoom out on the screen.</p> <p> : Return the display area of the screen to the preset position.</p>
9	Talk	Tap to begin communication.
10	Record	Tap this to begin record video/audio/
11	End	Tap this to end communication.

- Pressing any part of the screen other than an icon while video is displayed from the camera will hide the icons for a certain period of time. Tap the screen again to display the icons.

Communication Screen



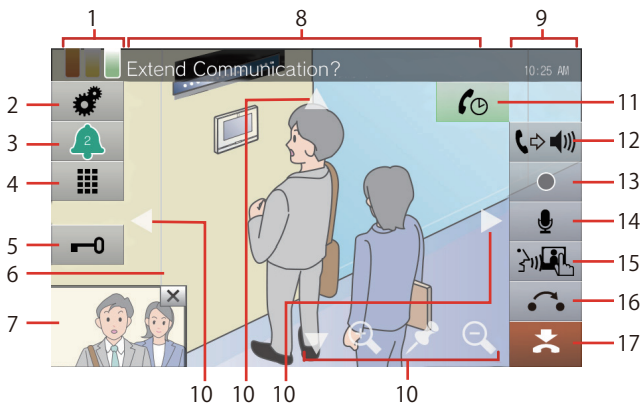

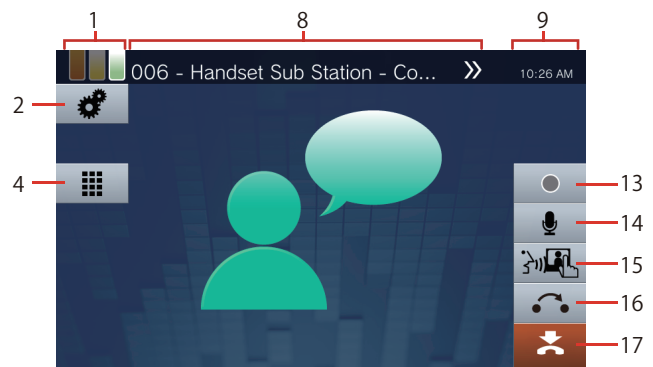

When receiving a call from a video station



When receiving a call from an audio station



Number	Name	Description
1	Priority	Indicates the priority level of the current call. : Urgent, : Priority, : Normal
2	Settings	The following items can be adjusted. (→page 76) <ul style="list-style-type: none"> : Zoom lock : Backlight compensation and nighttime sensitivity correction for video : Screen brightness : Receive volume : Mic volume : Ringtone
3	Number of incoming calls and priority	Shows the number of incoming calls and priority. Tap to display the calling stations in a list and select a station to answer. (→page 74) : Urgent, : Priority, : Normal
4	Keypad	Press this to display the Keypad. The keypad can be used to unlock the door (→page 71) or play Communication Audio Messages (→page 89).
5	Unlock	Unlock the door. (→page 71)
6	Primary video display area	Shows video from the calling station or associated network camera.
7	Secondary video display area	Displays if a network camera is associated with the other station, and the station has a camera. If the calling station is IX-MV7-* and there is no associated network camera, the video from this station will be displayed. A different video will be displayed from what is displayed in the primary video display area.
8	Calling Station	Shows the station number, station name (Option Input name), and location of the other station. If a network camera is associated with the other station, the name of the network camera will also be displayed (The text may not appear correctly depending on the setting language.) If the text does not appear correctly, tap to scroll the display.
9	Time	Indicates the current time.

Number	Name	Description
10	Screen control icon	<p>Tap these to change the visible display area of the screen. This cannot be done if the icon is not displayed. (→page 76)</p> <p> : Move the screen up.</p> <p> : Move the screen down.</p> <p> : Move the screen left.</p> <p> : Move the screen right.</p> <p> : Zoom in on the screen.</p> <p> : Zoom out on the screen.</p> <p> : Return the display area of the screen to the preset position.</p>
11	Extend	Tap this to extend the call duration for approximately 10 minutes.
12	Hands free	Tap this to switch between a handset call and a hands-free call.
13	Record	Tap this to begin record video/audio. (→page 75)
14	Mute mode	Tap this to turn the microphone and camera image from this station off when a call is answered with Auto Answer, so that audio and video are not sent to the other person.
15	Touch-to-talk	Tap this to switch to a touch-to-talk call. (→page 23)
16	On hold	Tap this to put the call on hold. (→page 73)
17	End	Tap this to end communication.

- Pressing any part of the screen other than an icon while video displayed from the camera will hide the icons for a certain period of time. Tap the screen again to display the icons.

Entering Text

Use this to search in the Address Book.

Example: Address book search screen

Alphabet input mode

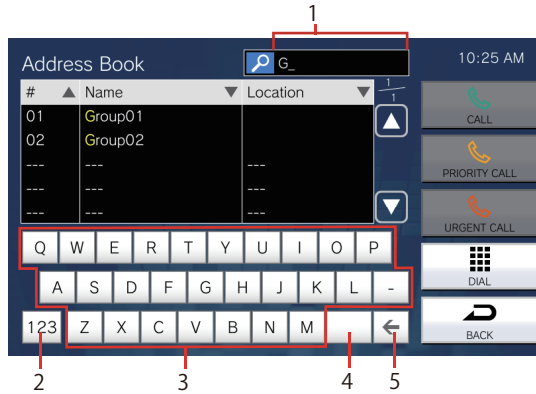

Number	Name	Description
1	Text field	This shows entered text.
2	Input mode	Input mode changes from "Alphabet" to "Numerals" and "Symbols" each time it is tapped. Input modes vary depending on the Search screen.
3	Characters	Tap to enter a character.
4	Space	Tap to insert a (blank) space.
5	Backspace	Tap to delete the previous character.

Numeral/symbol input mode

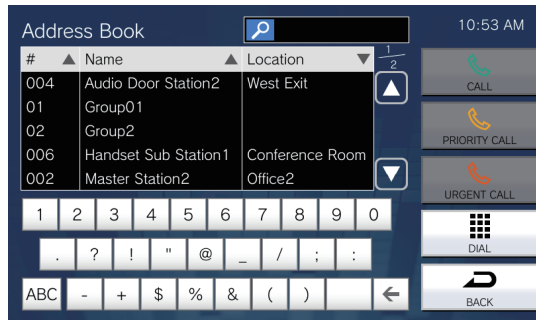

Answering a call

Answering a call with the handset

1. Lift the handset when receiving a call

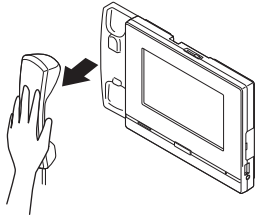

2. Speak with the other party

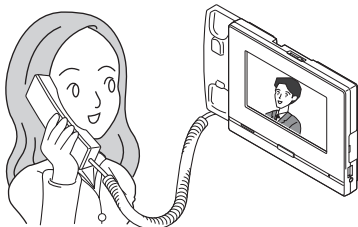

3. When the communication ends, hang up handset.

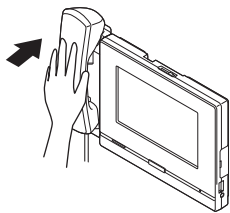

Note

- If the calling destination is located in an environment prone to echoing, your voice and ambient noise may echo and be heard on the station during a call. This can be improved by adjusting the microphone volume on this station or the receive volume on the other station.

Receiving a call with hands-free

1. When receiving a call, tap .

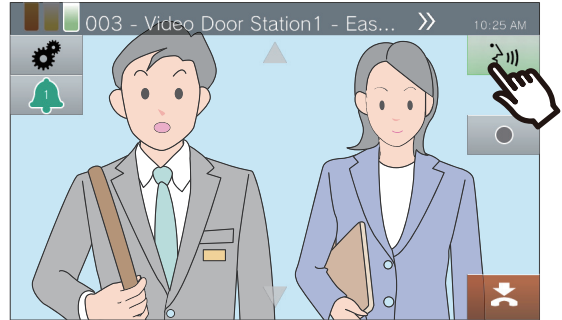

2. Speak with the other party

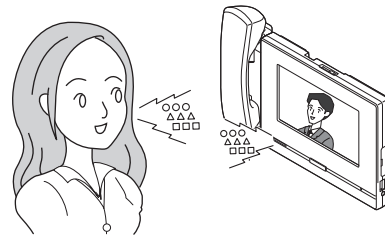

3. When the communication ends, tap .

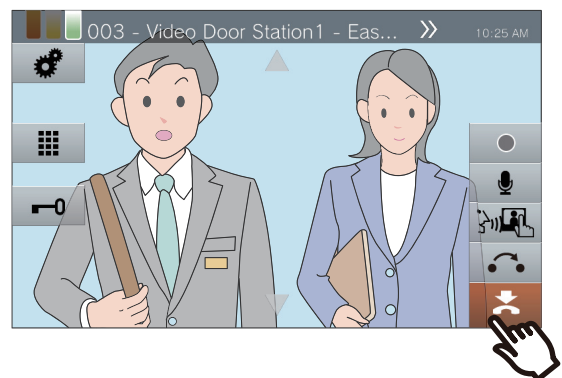



Note

- Lifting the handset during a hands-free call will switch the call to the handset.
- It may be difficult to listen or talk hands-free when the ambient noise is loud. Talk using the handset or touch-to-talk. ([→page 23](#))
- If the calling destination is located in an environment prone to echoing, your voice and ambient noise may echo and be heard on the station during a call. This can be improved by adjusting the microphone volume on this station or the receive volume on the other station.



Communicate using touch-to-talk

This station prioritizes the louder side of a conversation so that the quieter side can be heard. Touch-to-talk manually switches between the sides. It is useful when the ambient noise is loud enough to interrupt audio.

1. Tap  during communication.

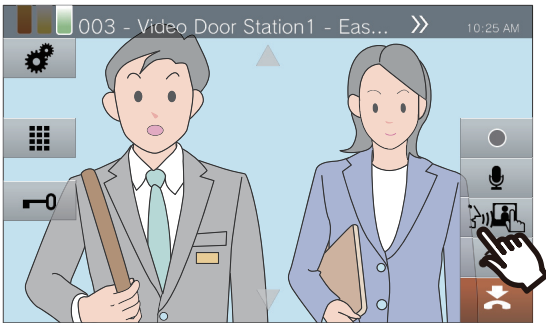

- If  is not displayed, proceed to the next step.

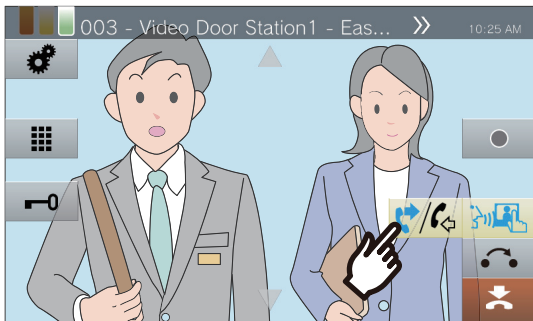

2. Tap  to switch to  and start speaking.



- The other party's audio cannot be heard.

3. To hear the voice of the other party, tap  to switch to .

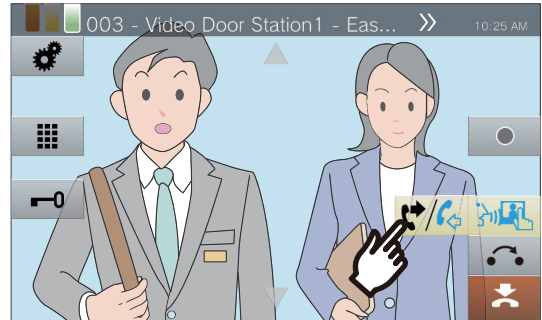

- The other party cannot hear this station's audio.

Note

- Touch-to-talk can also be used during a handset or hands-free call.
- To stop touch-to-talk, tap .

Using the headset

A 3rd party headset can be connected to the 3.5 mm 4-pole stereo mini jack on this station. When using the headset, the microphone and the speaker on the station cannot be used. The system administrator will need to configure the device to use a headset.

1. When receiving a call, tap .

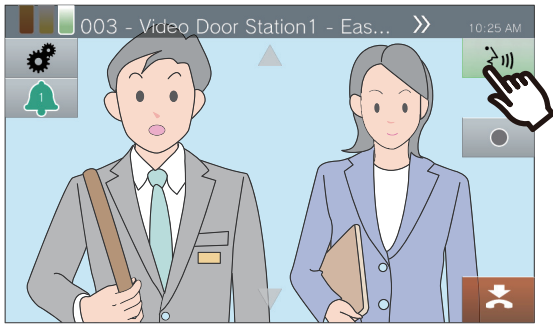

2. Speak with the other party

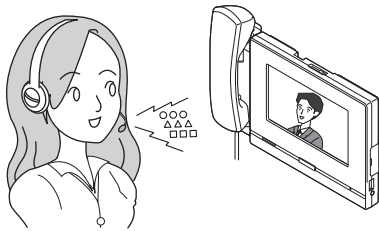

3. When the communication ends, tap .

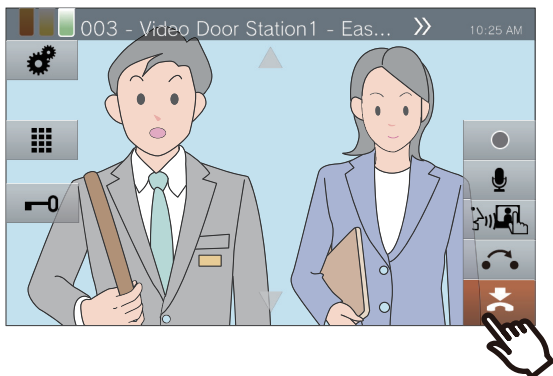

Note

- Picking up the handset while on a call using a headset will switch the call to the handset.

Setting the date and time

The date and time are used for video/audio recording and the incoming/outgoing call history. Be sure to set them correctly. When the station is synchronized with a NTP server, date and time will be automatically configured. Default value: January 1, 2018 09:00

1. Tap **[Settings]** on the Home screen.

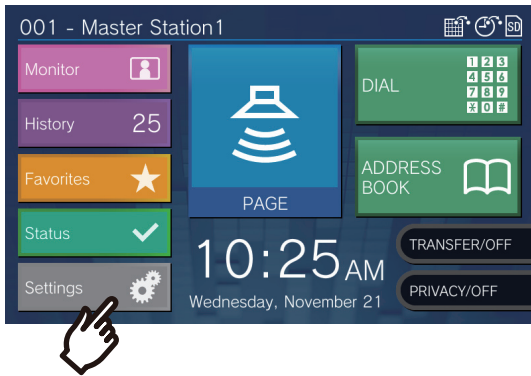

2. Tap **[User]**.

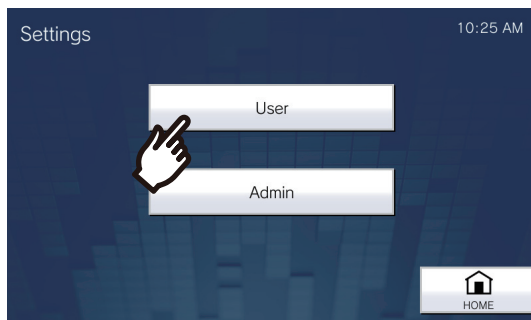

3. Tap **[Station]**.

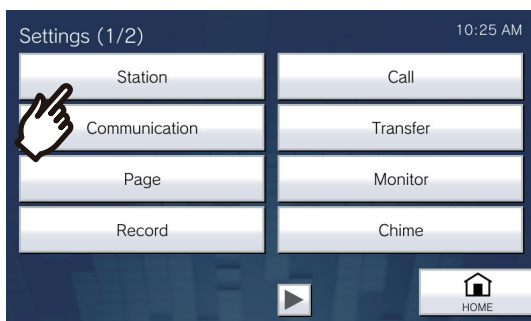

4. Tap **[Date and Time]**.

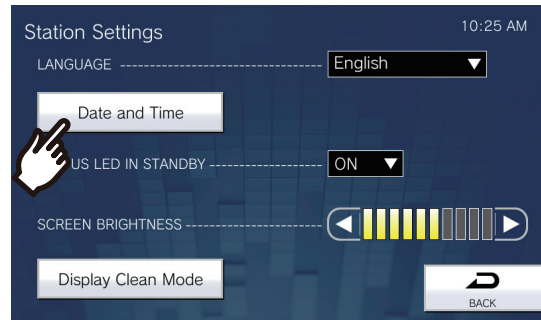

5. Set **[DATE]** and **[TIME]**.

- Set the time zone before configuring the date and time.

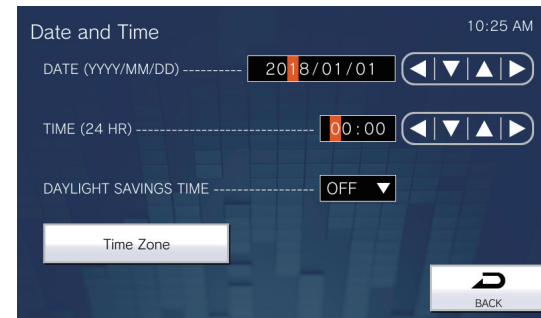

6. Tap **[BACK]**.

- The configured date and time will be applied to this station.



Note

- A maximum of 1 minute time gain/loss can occur in the displayed time over a month. It is recommended to correct the time periodically.
- If the power is turned off for at least 30 minutes in an event such as a power outage, the date and time return to default. If this occurs, configure the date and time again.
- If the station is inactive for approximately one minute, the station will return to the Home Screen.
- If the date and time are changed, it may take some time for the setting to be updated.

About microSD card

microSD cards that can be used with this station (sold separately)

Choose a microSD card using the recommended specifications below (these are referred to collectively as "microSD cards").

Standard	Supported storage capacity	Format	Speed class
microSDHC memory cards	4 GB to 32 GB	FAT32	SD speed class 10
microSDXC memory cards	64 GB to 128 GB	exFAT	UHS speed class 1

Important

- A microSD card is not included with this station.
- Some microSD cards may not operate properly.
- If the card contains data other than video/audio files, it may not have enough space to record video/audio recordings.
- The network camera may not be able to record video, depending on the size of the video.
- Recording files cannot be protected with microSDXC memory card ([→page 61](#)).

Note

- A maximum of 999 video/audio files can be saved. However, this may vary depending on the size of the video/audio files and the capacity of the microSD card.
- Line Supervision Results and Device Check Results are also saved to the microSD card.
- Aiphone is not to be held responsible in any way for microSD cards.

Inserting/Removing microSD Cards

Inserting the microSD card

1. Press the Home button or tap the standby screen to display the Home Screen.

2. Open the microSD card slot cover.

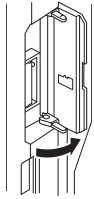

3. Insert the microSD card straight into the slot and close the cover.

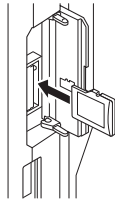

-  will be displayed on the screen once the microSD card is recognized (mounted), and the microSD card will be available to use.

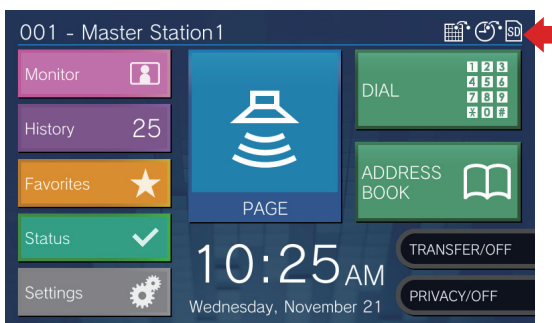

 will not be displayed if the microSD card is not recognized.

Removing the microSD card

1. Tap .

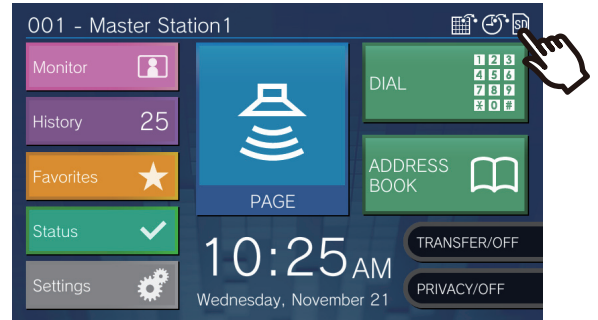

2. Tap [Yes].

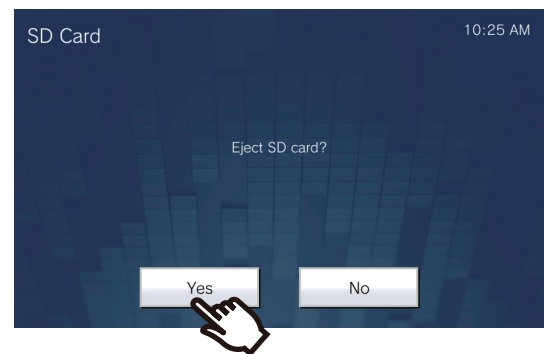

-  disappears from the screen when the microSD card has been removed.

3. Once  disappears from the Home Screen, open the microSD card slot cover, and push the microSD card to remove it.

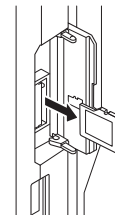

Important

- Insert or remove the microSD card only when the station is not receiving a call. Calls and other similar operations cannot be performed while the microSD card is mounted.
- Removing the microSD card before  disappears could cause data corruption.

Selecting / Choosing / Calling by Number

When making a call, specify a station or group by the station number (extension number or external number) or group number.

1. Tap **[DIAL]** on Home Screen 1.

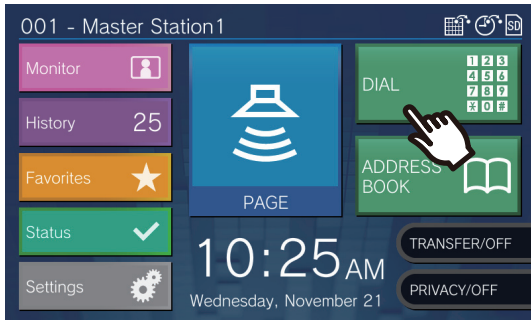

2. Enter the station number or group number using the keypad

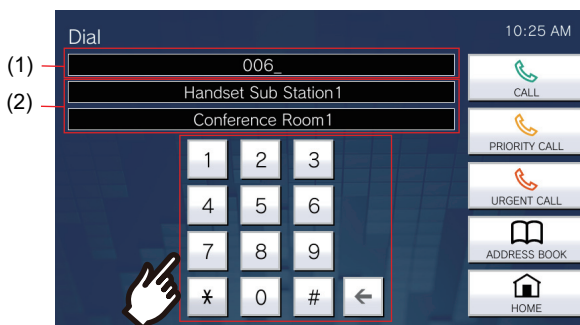

- (1) The entered number will be displayed.
 - (2) The station name and location or group name will be displayed for the number that was entered.
- Tap **[ADDRESS BOOK]** to specify a station or group from the Address Book. ([→page 31](#))

Note

- To make a call to the specified station or group, refer to
 - [“Placing a Call \(→page 35\)”](#)
 - [“Calling a Group \(→page 37\)”](#)

Specify a station or group using the address book.

When calling, specify a station or group registered in the Address Book from the list.

1. Tap **[ADDRESS BOOK]** on Home Screen 1 or **[CALL]** on Home Screen 2.

Home Screen 1

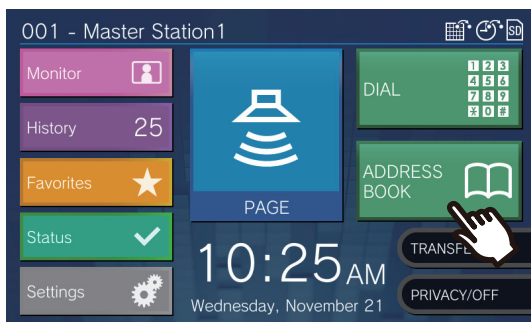

Or

Home Screen 2



2. Tap the station or group to call.

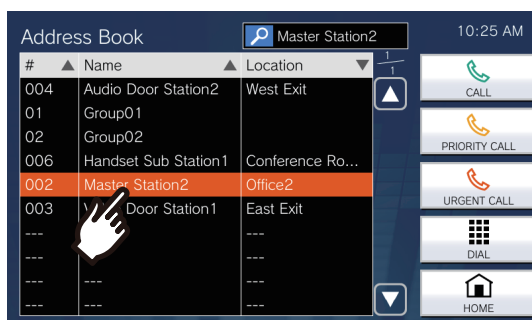

- Tap **[DIAL]** to search by station or group number. ([→page 30](#))
- Refer to ([→page 32](#)) to search stations or groups.

Searching for stations

Enter characters to search and specify stations, groups, or messages.

<Example: Making an outgoing call>

1. Tap .

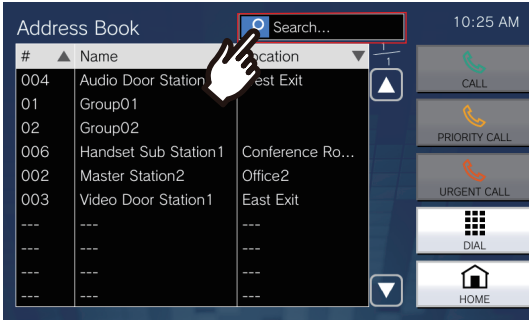

3. Tap the station or group to call.

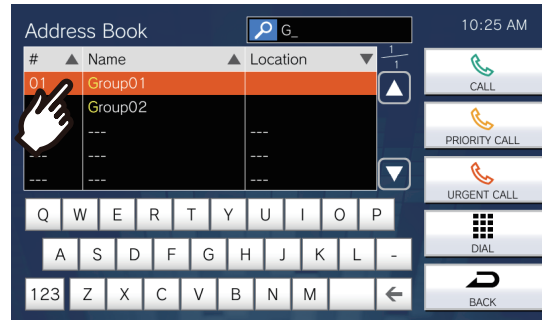

2. Enter the name or number of the station or group to search.

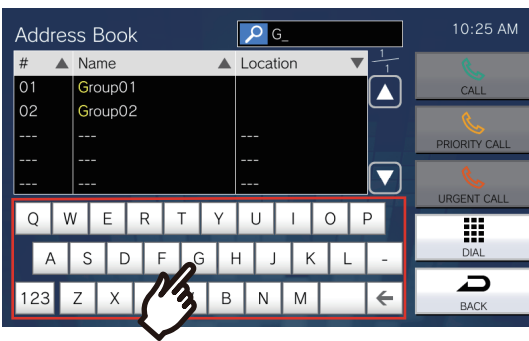

- Refer to ([→page 20](#)) for information on how to enter characters.

Note

- To place a call to the specified station or group, refer to
 - [“Placing a Call \(→page 35\)”](#)
 - [“Calling a Group \(→page 37\)”](#)
 - [“Paging a group \(→page 43\)”](#)
 - [“Message Paging a group \(→page 47\)”](#)
- To monitor the specified station, refer to
 - [“Monitoring a door station \(→page 56\)”](#)
- To transfer a call to the specified station, refer to
 - [“Transfer calls \(during communication\) \(→page 65\)”](#)

Reviewing Call History

Incoming/outgoing/missed call history and the history of recordings can be viewed. Monitoring is not logged in the call history.

Up to 500 incoming/outgoing call records can be saved. New records will be saved over the oldest records if the number of records exceeds 500.

1. Tap **[History]** on the Home Screen.

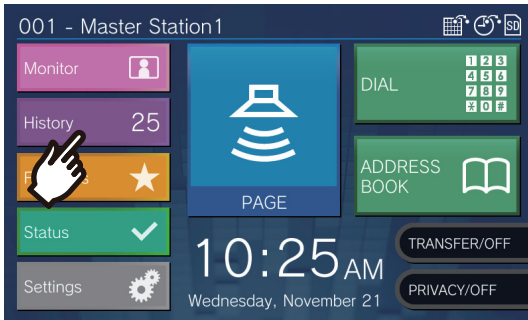

2. Select the type of the history and tap the button.

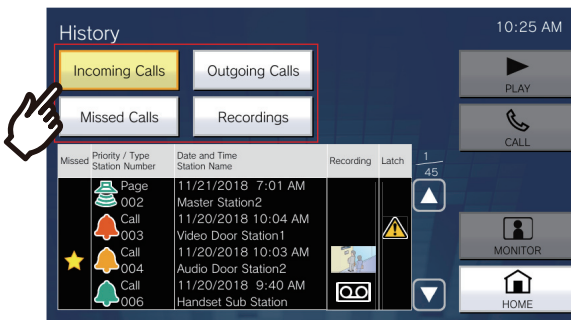

[Incoming Calls]

Tap to display the history of incoming calls and pages.

[Outgoing Calls]

Tap to display the history of outgoing calls and pages.

[Missed Calls]

The history of received calls which are not answered is displayed.

If another station answers, the history will be displayed in **[Incoming Calls]**.

[Recordings]

Press this to display the history of video/audio recording during incoming calls, communication, and monitoring.

3. Use ▲ or ▼ to view the history.

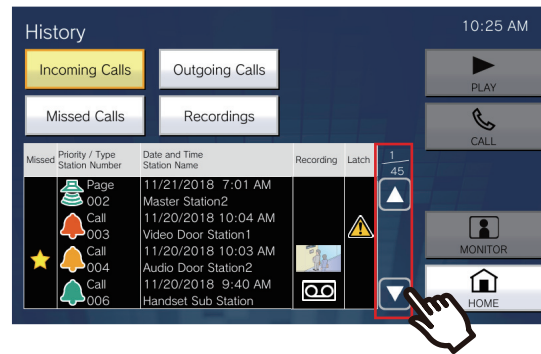

- Refer to (→page 34) for viewing the history screen.

4. Place a call using the history.



- Refer to (→page 34) for viewing the history screen.

Note

- The buttons displayed on the screen will vary depending on the selected history type.

History Screen

Outgoing call history screen

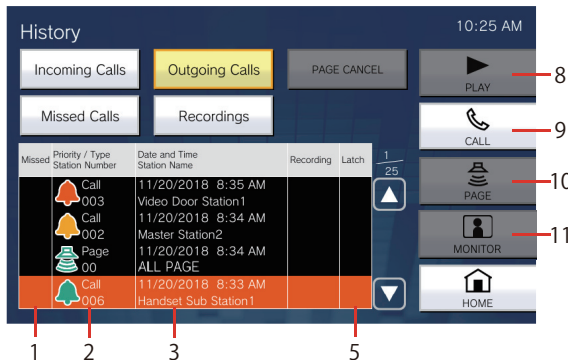

Recording history screen

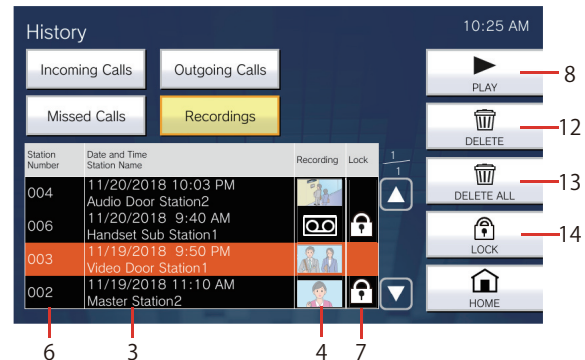

Number	Name	Description
1	Missed	: This is displayed for unanswered calls in the history. It is not displayed if the other station answered.
2	Priority/Type Station Number	: This is displayed for calls in the history. The color indicates the priority (red: urgent, orange: priority, green: normal). : This is displayed for paging in the history. The color indicates the priority (red: urgent, green: normal). The operation type and the station or group number of the destination station will be shown.
3	Date and time Station Name	Shows the logged date and time. The station or group name of the destination station is also shown.
4	Recording	A recorded video image is displayed if there is a video/audio recording in the history. is displayed if recorded audio is in the history.
5	Latch	: This is displayed if Latch Reset is not performed when Bathroom Call is received or an incoming call associated with the strobe light is received.
6	Station Number	Shows the station number that recorded the video/audio.
7	Lock	: This is displayed for protected video/audio recordings in the history.
8	PLAY	Tap to play the selected video/audio recording in the history.
9	CALL	Tap to call the selected station or group in the history.
10	PAGE	Tap to page the selected group in the history.
11	MONITOR	Tap to monitor the selected station in the history.
12	DELETE	Tap to delete the selected video/audio recording in the history.
13	DELETE ALL	Tap to delete all video/audio recordings in the history.
14	LOCK/UNLOCK (For microSDHC memory cards)	Tap to lock/unlock the selected video/audio recording in the history. Protected content cannot be overwritten or deleted.

Placing a Call

1. Lift the handset.

- If there is no handset, proceed to the next step.
- If the handset is lifted after specifying a station, the call will be placed under **[Normal]** priority.

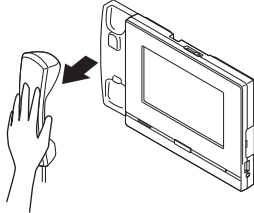

2. Specify a station to call.

- Choose a station using the methods below.
 - “[Selecting / Choosing / Calling by Number](#) (→page 30)”
 - “[Specify a station or group using the address book.](#) (→page 31)”

3. Tap **[CALL]**, **[PRIORITY CALL]**, or **[URGENT CALL]**.

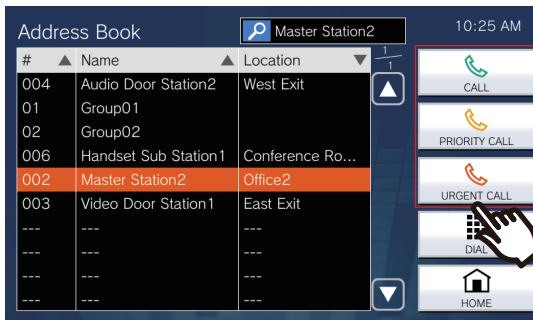

- The call will be placed with the selected priority.
- The ringback tone is heard from the handset or the built-in speaker.
- Refer to (page 74, page 78, and page 79) for operations when making an outgoing call.

4. Speak when the other party answers

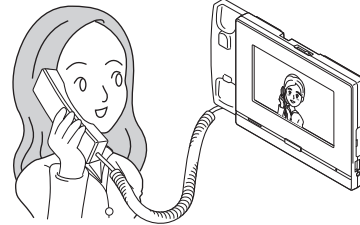

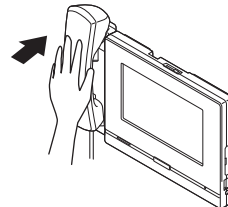

- For viewing the screen during communication, refer to (→page 18).
- Refer to (page 71 through page 80) for operations during a call.
- If the other party uses is IX-MV7-* or a VoIP Phone, the image from the camera on this station will be displayed on the other party's station.
However, the image may not be displayed depending on the specifications and configuration of the VoIP phone.

5. When the communication ends, hang up handset or tap .



Note

- When calling a VoIP Phone, this will be the shorter time of the time set for "Call Timeout" or the call duration configured on the IP-PBX.
- It may not be possible to place a call. It depends on the configuration of the station.
- The ringback tone may not be played, depending on the settings.
- If the call duration configured on this station (for calls with a VoIP phone, the call duration configured on the VoIP phone) elapses, the call will automatically end. A notification tone will play approximately 10 seconds prior to the call ending. The notification tone may not play, depending on the settings.
- If a page with a higher priority is received from another station while making an outgoing call or during communication, the outgoing call or call will be interrupted and the station will switch to the page.
- Tap  during a call to turn off the microphone and camera of the station. Tap  to turn them back on.
- When receiving another call while talking, a notification tone will be heard from the handset or built-in speaker. Tap  to choose the station to communicate with.

(→page 74)

Calling a Group

Place an outgoing call to all stations that belong to the selected group, and communicate with the first station to answer.

1. Lift the handset.

- If there is no handset, proceed to the next step.
- If the handset is lifted after specifying a group, the call will be placed under **[Normal]** priority.

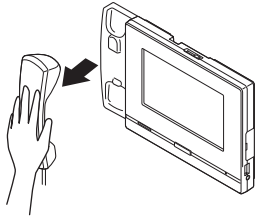

2. Specify the group to call.

- Choose a group using the methods below.
 - “[Selecting / Choosing / Calling by Number](#) (→page 30)”
 - “[Specify a station or group using the address book.](#) (→page 31)”

3. Tap [CALL], [PRIORITY CALL], or [URGENT CALL].

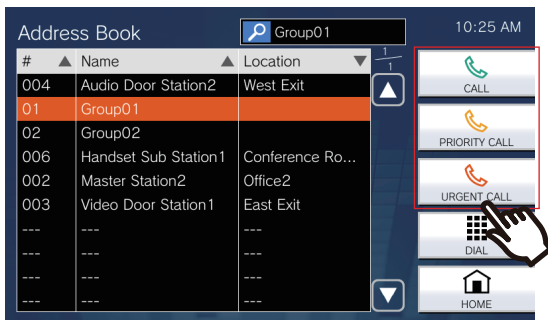

- The group call will be placed with the selected priority.
- The ringback tone is heard from the handset or the built-in speaker.
- Refer to (page 74, page 78, and page 79) for operations when making an outgoing call.

4. Speak when the other party answers

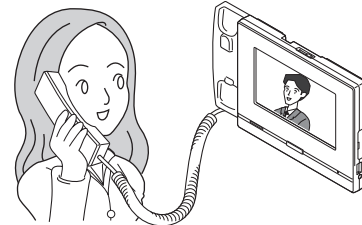

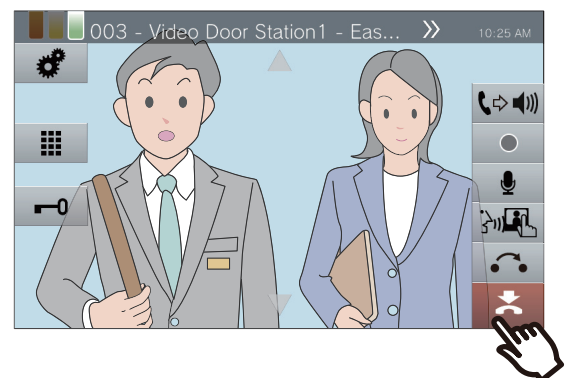
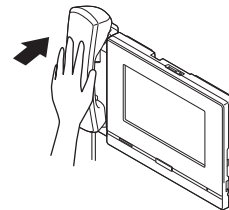

- For how to use the screen during a call, refer to (→page 18).
- Refer to (page 71 through page 80) for operations during a call.
- If the other party uses a VoIP Phone, the image may not be displayed depending on the specifications and configuration of the VoIP Phone.

5. When the communication ends, hang up handset or tap .



Note

- When calling a VoIP Phone, this will be the shorter time of the time set for "Call Timeout" or the call duration configured on the IP-PBX.
- It may not be possible to place a call. It depends on the configuration of the station.
- The ringback tone may not be played, depending on the settings.
- If the call duration configured on this station (for calls with a VoIP phone, the call duration configured on the VoIP phone) elapses, the call will automatically end. A notification tone will play approximately 10 seconds prior to the call ending. The notification tone may not play, depending on the settings.
- If a page with a higher priority is received from another station while making an outgoing call or during communication, the outgoing call or call will be interrupted and the station will switch to the page.
- Tap  during a call to turn off the microphone and camera of the station. Tap  to turn them back on.
- When receiving another call while talking, a notification tone will be heard from the handset or built-in speaker. Tap  to choose the station to communicate with. ([→page 74](#))
- If the call destination includes a VoIP Phone configured to automatically answer a call, the VoIP Phone will automatically answer.

Use an external device to place a call

Use an external device (sensor, call button, etc.) to place a call to a pre-determined location.

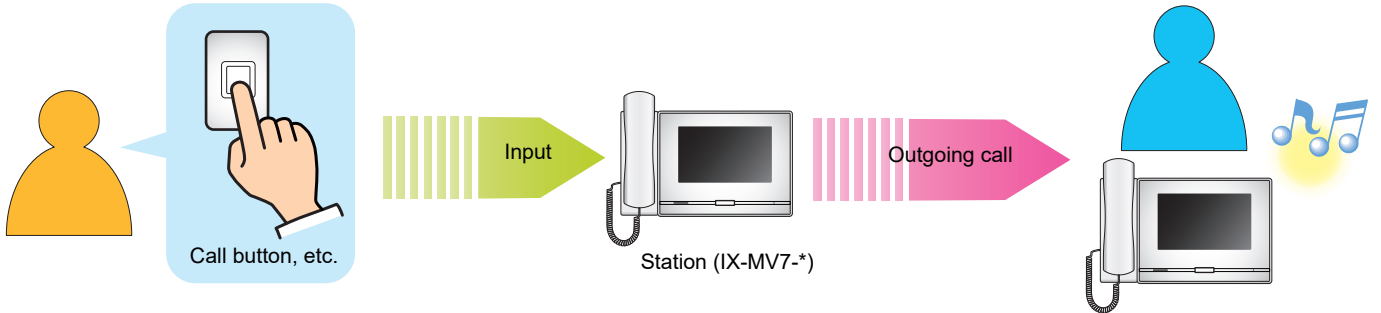

1. Activate the external device

- The ringback tone will play from the speaker of the station.

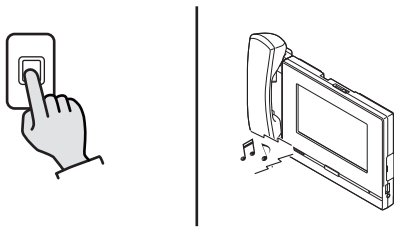

3. To end communication, hang up the handset or tap .

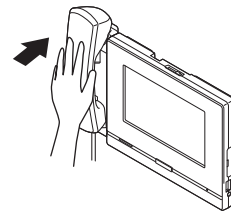

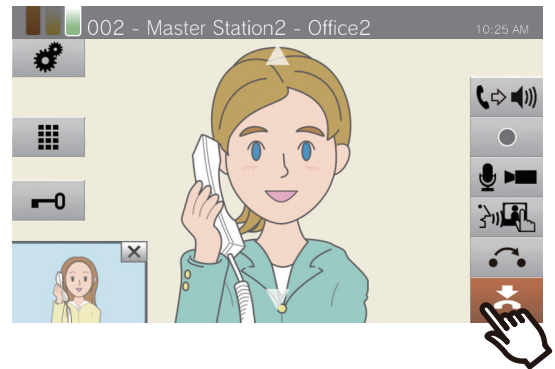
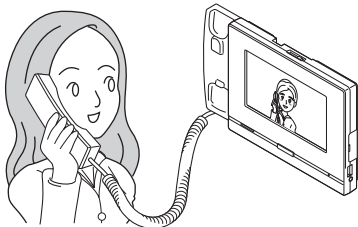

2. Speak when the other party answers

- Lift the handset to switch to handset communication.



- For how to view the screen during a call, refer to ([→page 18](#)).
- Refer to ([page 71](#) through [page 80](#)) for operations during a call.

Note

- When calling a VoIP Phone, this will be the shorter time of the time set for "Call Timeout" or the call duration configured on the IP-PBX.
- It may not be possible to place a call. It depends on the configuration of the station.
- The call is placed using the priority that was set during programming.
- The ringback tone may not be played, depending on the settings.
- If the call duration configured on this station (for calls with a VoIP Phone, the call duration configured on the VoIP Phone) elapses, the call will automatically end. A notification tone will play approximately 10 seconds prior to the call ending. The notification tone may not play, depending on the settings.
- If a page with a higher priority is received from another station while making an outgoing call or during a communication, the outgoing call or call will be interrupted and the station will switch to the page.
- Tap  during a call to turn off the microphone and camera of the station. Tap  to turn them back on.
- When receiving another call while talking, a notification tone will be heard from the handset or built-in speaker. Tap  to choose the station to communicate with. ([→page 74](#))
- If the call destination includes a VoIP Phone configured to automatically answer a call, the VoIP Phone will automatically answer.

Answering a call

When receiving a call, the ringtone sounds and the video image shows up on the screen.
 <Example: Incoming from a Video Door Station>

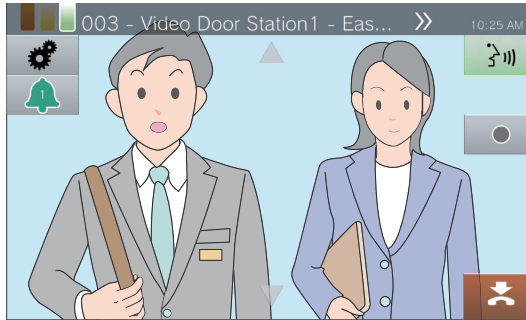

1. When receiving a call lift the handset or tap .

• Refer to (page 71 through page 80) for operations during a call.

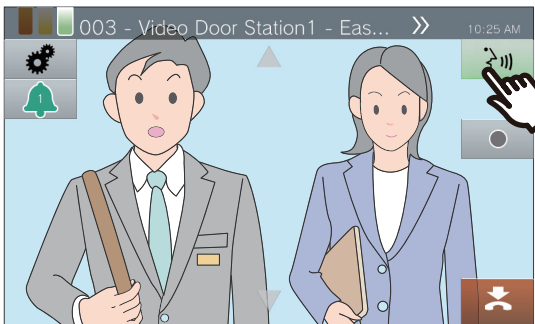
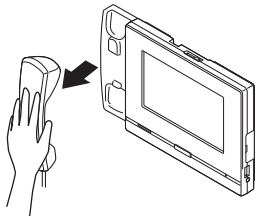

- Refer to (→page 16) for how to view the screen when receiving a call.
- Refer to (page 74, page 78, and page 81) for operations when receiving a call.

3. To end communication, hang up the handset or tap .

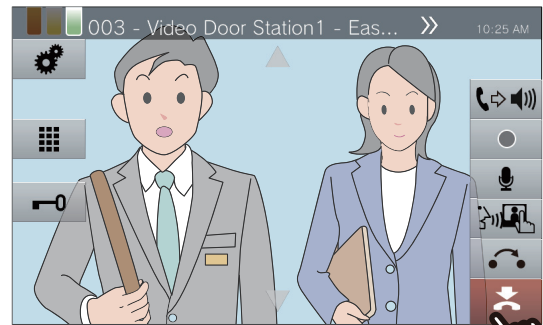
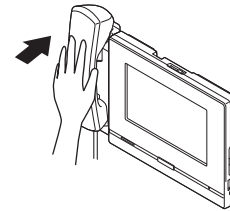

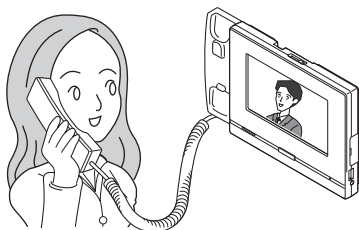

2. Speak with the other party



- For how to view the screen during a call, refer to (→page 18).



Note

- Depending on the configuration, the ringtone may be heard from a separately installed speaker or other device.
- If the call duration configured on the other station (for calls with a VoIP phone, the call duration configured on the VoIP phone) elapses, the call will automatically end. A notification tone will play approximately 10 seconds prior to the call ending. The notification tone may not play, depending on the settings.
- If a page with a higher priority is received from another station during communication, the call will be interrupted and the station will switch to the page.
- If a page or a call with a higher priority is received from another station while receiving a call, the station will switch to the page or call with a higher priority.
- The ringtone may not sound, depending on the configuration.
- Tap  during a call to turn off the microphone and camera of the station. Tap  to turn them back on.
- When receiving two or more calls simultaneously, tap  to choose the station to communicate with. ([→page 74](#))
- When Auto Answer ([→page 110](#)) is "ON," an individual call from another Master Station will be answered automatically. It will not automatically answer a group call or a call from a handset sub station or Door Station.

Paging a group

Send a page to all stations (other than VoIP phones) that belong to a selected group.

[PAGE] may not be displayed on the Home Screen, depending on the configuration. If this is the case, this function cannot be used.

1. Lift the handset.

- If there is no handset, proceed to the next step.
- If the handset is lifted after specifying a group, the page will be sent under **[Normal]** priority.

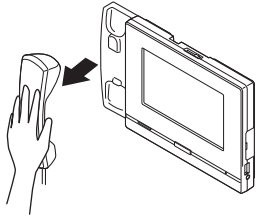

2. Tap **[PAGE]** on the Home Screen.

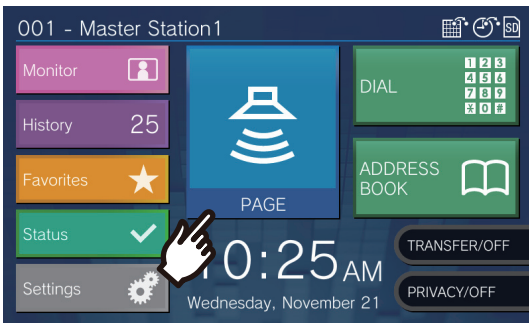

3. Select the group to page.

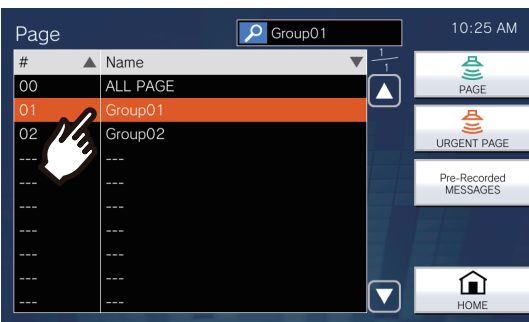

- Refer to ([→page 32](#)) for how to search groups.

4. Tap **[PAGE]** or **[URGENT PAGE]**.

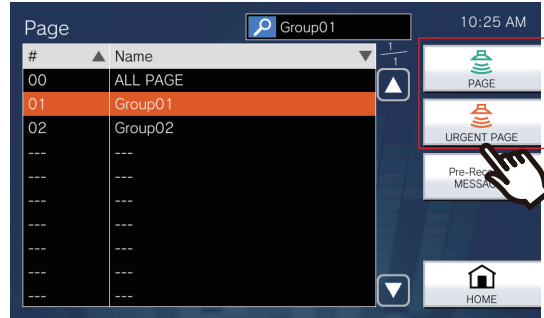

- The page will be sent with the selected priority.

5. Speak after the paging pretone.

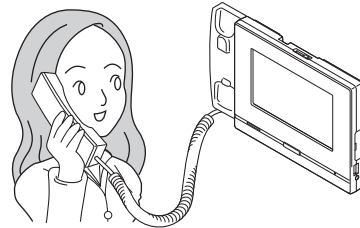

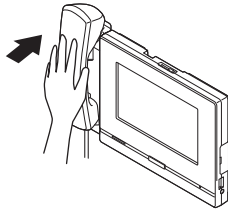

- Refer to ([page 74](#), [page 78](#), and [page 80](#)) for operations when paging.

6. After paging, hang up handset or tap .



 **Note**

- When the station being paged answers, the page will end and a call will be established with the station that answered.
- The ringback tone will sound until paging begins.
- Depending on the configuration, the Paging Pretone may be heard from an externally installed speaker or other device.
- If the Paging Timeout was previously set on this station elapses, the page will automatically end. A notification tone will play approximately 10 seconds prior to the page ending. The notification tone may not play, depending on the configuration.
- The Paging Pretone may not sound, depending on the configuration.
- If a page with a higher priority is received from another station during a page or call, the page or call will be interrupted and the station will switch to the page with the higher priority.
- When receiving another call while paging, a notification tone will be heard from the handset or built-in speaker. Tap  to choose the station to speak. ([→page 74](#))
- Tap  while paging to turn off the microphone of the handset and the station. Tap  to turn them back on.
- Paging to Handset Sub Stations and Door Stations is also possible.

Paging all stations

Send a page to all stations other than VoIP phones that are registered in the Address Book of this station.

[PAGE] may not be displayed on the Home Screen, depending on the configuration. If this is the case, this function cannot be used.

1. Lift the handset.

- If there is no handset, proceed to the next step.
- If the handset is lifted after specifying **[ALL PAGE]**, the page will be sent under **[Normal]** priority.

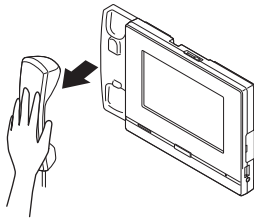

4. Tap **[PAGE]** or **[URGENT PAGE]**.

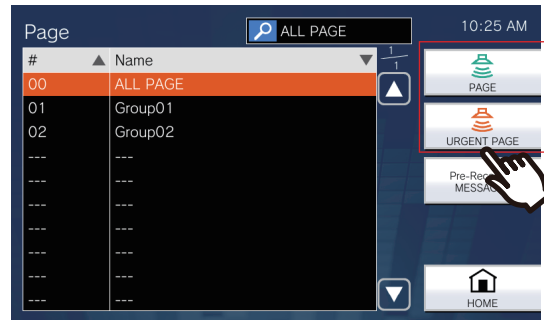

- The page will be sent with the selected priority.

2. Tap **[PAGE]** on the Home Screen.

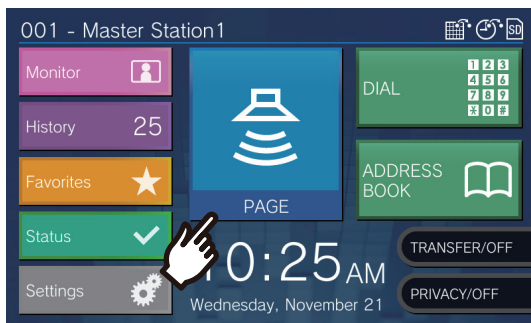

5. Speak after the paging pretone.

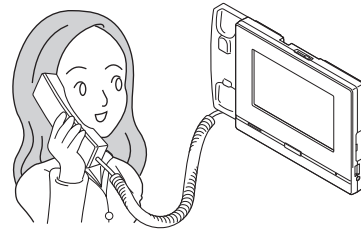

- Refer to (page 74, page 78, and page 80) for operations when paging.

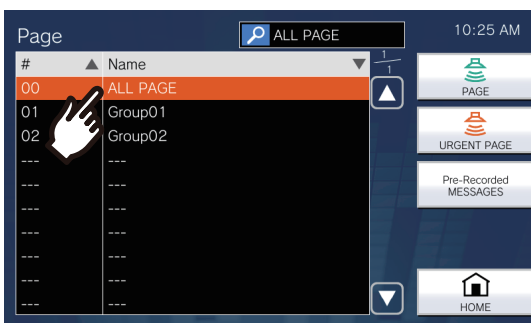

3. Tap **[ALL PAGE]**.

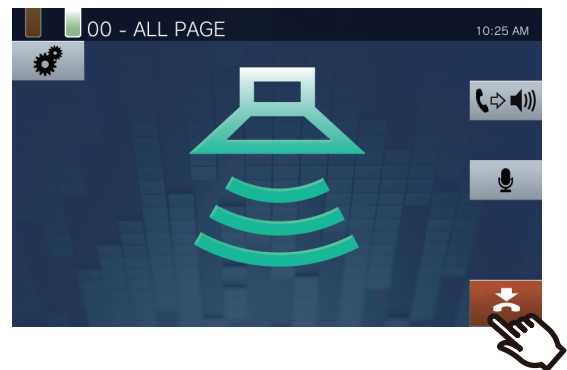

6. After paging, hang up handset or tap .



Note

- When the station being paged answers, the page will end and a call will be established with the station that answered.
- The ringback tone will sound until paging begins.
- Depending on the configuration, the Paging Pretone may be heard from an externally installed speaker or other device.
- If the Paging Timeout was previously set on this station elapses, the page will automatically end. A notification tone will play approximately 10 seconds prior to the page ending. The notification tone may not play, depending on the configuration.
- The Paging Pretone may not sound, depending on the configuration.
- If a page with a higher priority is received from another station during a page or call, the page or call will be interrupted and the station will switch to the page with the higher priority.
- When receiving another call while paging, a notification tone will be heard from the handset or built-in speaker. Tap  to choose the station to speak. ([→page 74](#))
- Tap  while paging to turn off the microphone of the handset and the station. Tap  to turn them back on.
- Paging to Handset Sub Stations and Door Stations is also possible.

Message Paging a group

Send a page to all stations (other than IX-MV, IX-DA, IX-BA and VoIP phones) that belong to a selected group using a pre-recorded message (audio data).

[PAGE] may not be displayed on the Home Screen, depending on the configuration. If this is the case, this function cannot be used.

1. Tap **[PAGE]** on the Home Screen.

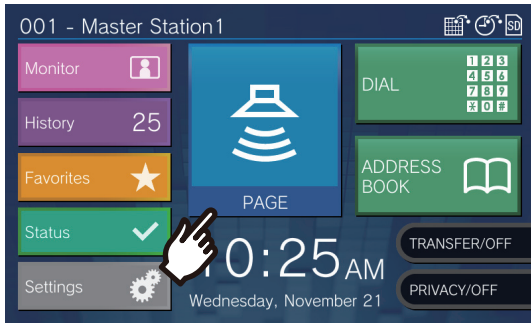

4. Tap the message to be sent during paging.

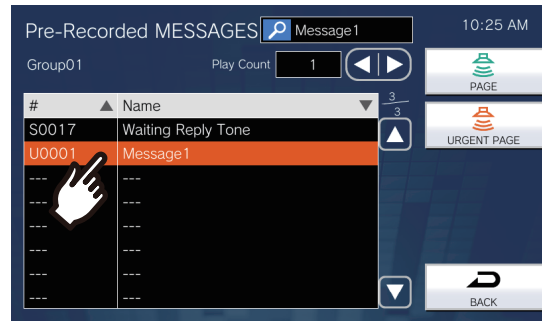

2. Tap the group to page.

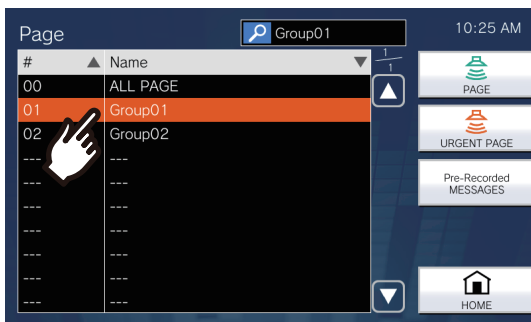

• Refer to ([→page 32](#)) for how to search groups.

• The selected message will be heard from the handset or built-in speaker.

5. Use **[◀]** or **[▶]** to set how many times the message is to be played.

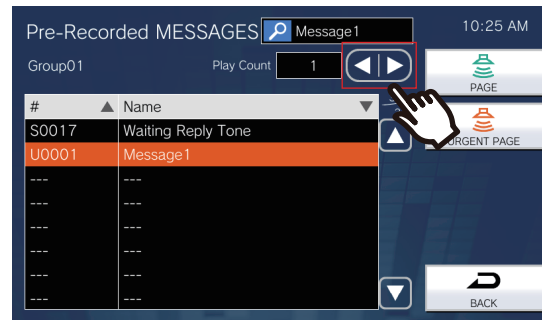

3. Tap **[Pre-Recorded MESSAGES]**.

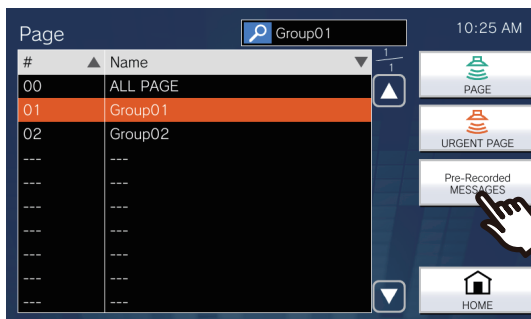

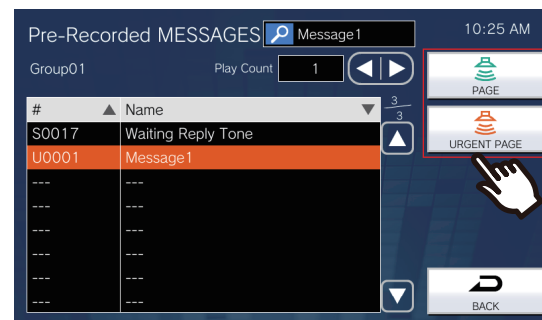

6. Tap **[PAGE]** or **[URGENT PAGE]**.

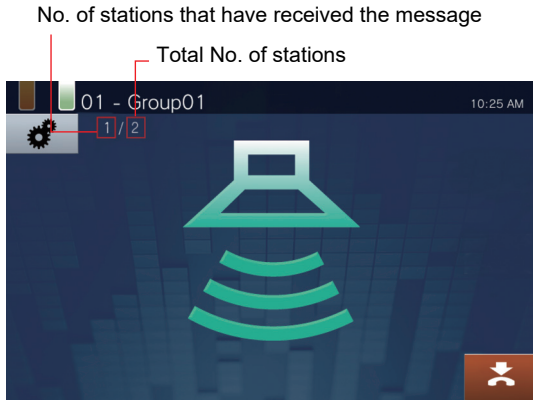

• The page will be sent with the selected priority.

7. After the message is sent, the screen will return to the Home Screen.



- : Tap this to end paging. However, messages that have already been sent and are playing on stations will not stop.

Canceling sent messages that are playing on stations

1. Tap **[History]** on the Home Screen.

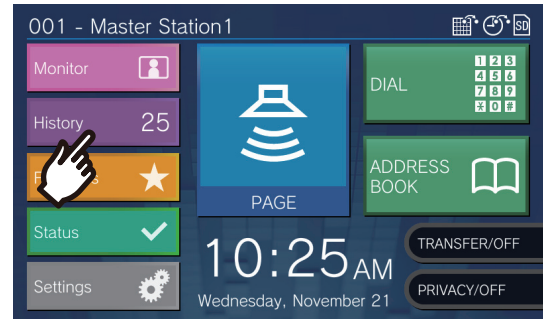

2. Tap **[Outgoing Calls]**.



3. Tap the message page to stop from the list.

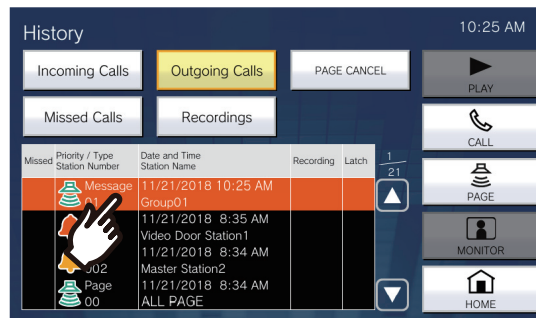

4. Tap [PAGE CANCEL].

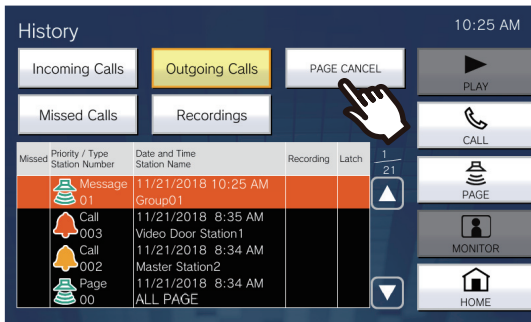

- Ends the Message Page.

Note

- The ringback tone plays until paging begins.
- Depending on the configuration, the Paging Pretone may be heard from an externally installed speaker or other device.
- If the destination station is on a call or is paging, the message may not play depending on the priority setting.
- Paging to Handset Sub Stations and Door Stations is also possible.

Message Paging all stations

Send a page to all stations (other than IX-MV, IX-DA, IX-BA and VoIP phones) that are registered in the Address Book of this station, using a prerecorded message.

[PAGE] may not be displayed on the Home Screen, depending on the configuration. If this is the case, this function cannot be used.

1. Tap **[PAGE]** on the Home Screen.

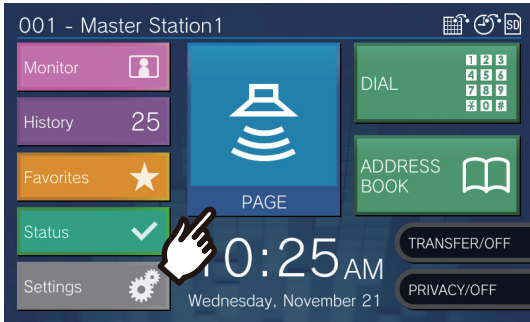

2. Tap **[ALL PAGE]**.

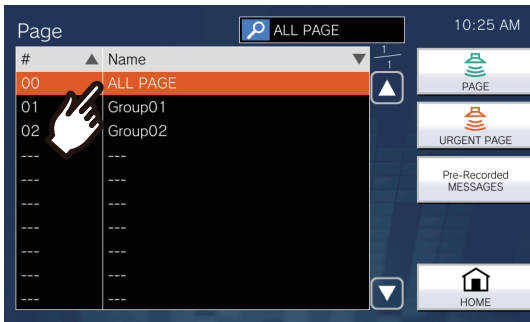

3. Tap **[Pre-Recorded MESSAGES]**.

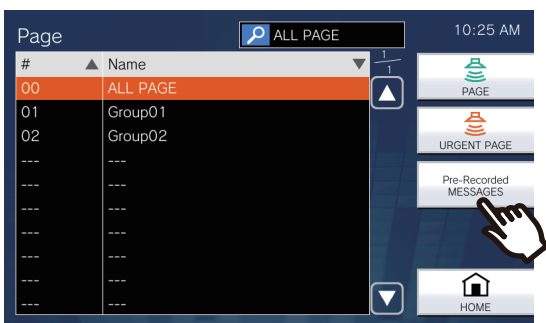

4. Tap the message to be sent during paging.

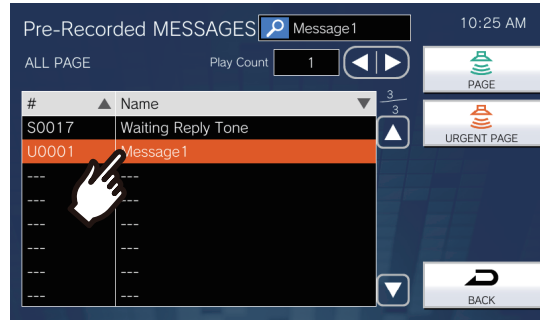

• The selected message will be heard from the handset or built-in speaker.

5. Use **◀** or **▶** to set how many times the message is to be played.

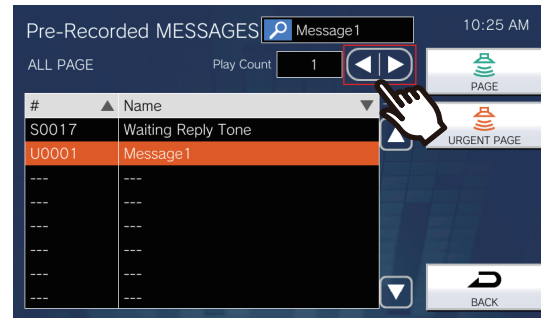

6. Tap [PAGE] or [URGENT PAGE].

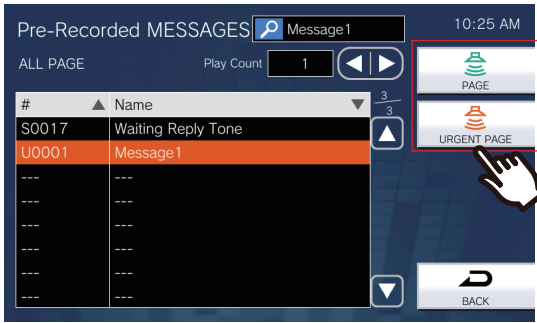

- The page will be sent with the selected priority.

7. After the message is sent, the screen will return to the Home Screen.



- : Press this to stop paging. However, messages that have already been sent and are playing on stations will not stop.

Canceling sent messages that are playing on stations

1. Tap [History] on the Home Screen.

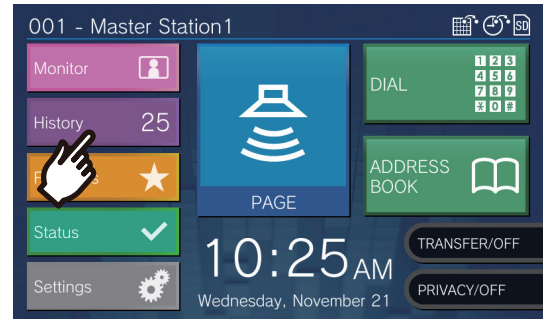

2. Tap [Outgoing Calls].

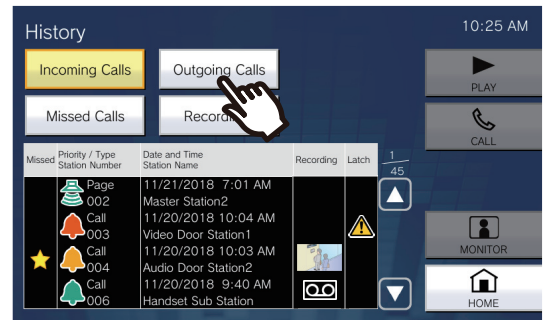

3. Tap the message page to stop from the list.

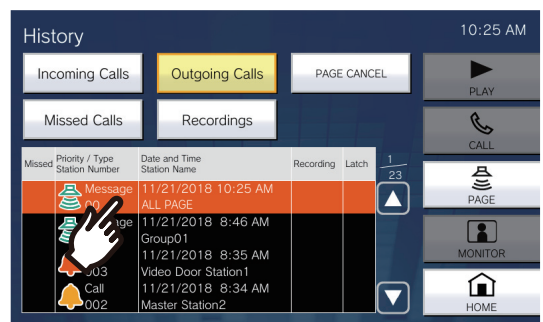

4. Tap [PAGE CANCEL].

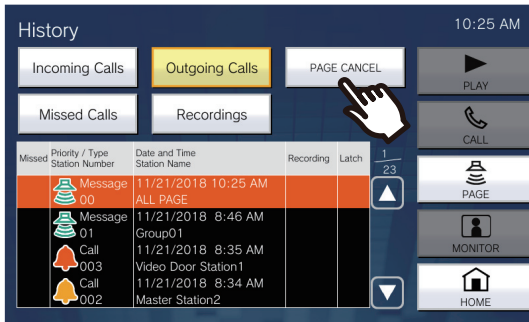

- Ends the Message Page.

Note

- The ringback tone plays until paging begins.
- Depending on the configuration, the Paging Pretone may be heard from an externally installed speaker or other device.
- If the destination station is on a call or is paging, the message may not play depending on the priority setting.
- Paging to Handset Sub Stations and Door Stations is also possible.

Contact Input Page

An external device (sensor, button) can be used to send a page or message page to a registered station (other than a VoIP phone), or page using an external audio source.

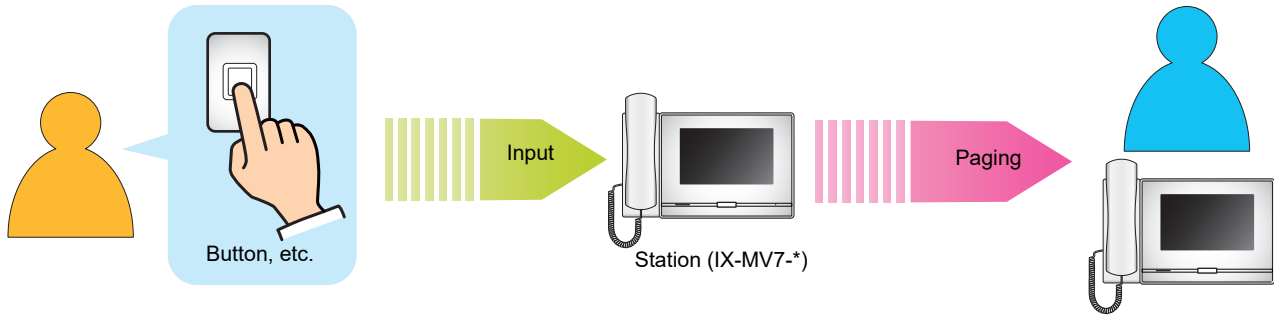

Receiving a page

When a page is received, the Paging Pretone will sound and the paging begins.

Depending on the configuration,  may be displayed when a page is received. Answering the page in this case will begin the call.

Refer to (page 78, page 79, and page 81) for operations when a page is received.

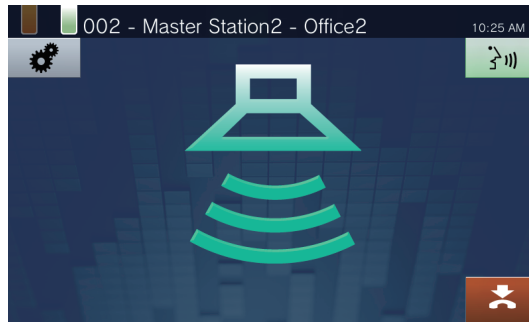

Answering pages

1. While receiving a page, lift the handset or tap .

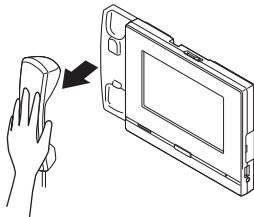

2. Speak with the other party



- For how to view the screen during a call, refer to ([→page 18](#)).
- Refer to (page 71 through page 80) for operations during a call.

3. To end communication, hang up the handset or tap .

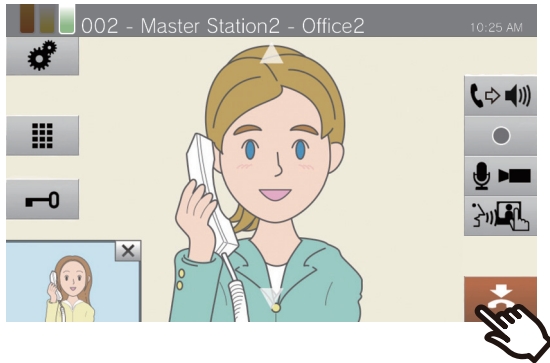
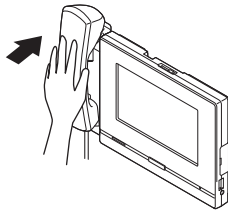

Note

- The Paging Pretone may not sound, depending on the configuration.
- Depending on the configuration, the paging pretone and incoming page tone may be heard from a separately installed speaker or other device.
- If a page with a higher priority is received from another station when paging or during a call, the page or call will be interrupted and the station will switch to the page with the higher priority.
- When receiving an incoming call from another station during paging, a notification tone will be heard from the handset or built-in speaker. Tap  to choose the station to speak. ([→page 74](#))
- When a station answers a page, the page will end on all other stations.

Monitoring a door station

Video and audio of a station and network camera can be monitored.

For stations without cameras, only audio will be heard while monitoring. Master Stations, VoIP phones, and groups cannot be monitored.

Audio of the station that initiates monitoring cannot be heard by the other party during monitoring. However, the other party may be notified that they are being monitored (a notification tone or flashing LED), depending on the configuration of the other station. It may not be possible to monitor the other station when the chime is playing on this station or when the other station is placing a call, receiving a call, receiving a page, or during communication depending on the settings.

1. Tap **[Monitor]** on the Home screen.

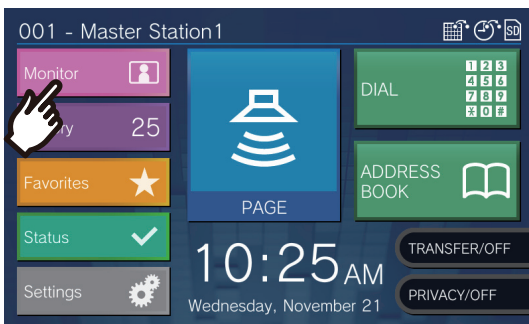

• The calling tone plays until monitoring begins.

4. View the video and audio.

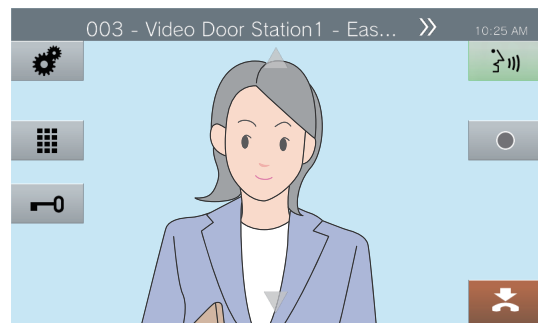

• Refer to (page 71 and page 75 through page 79) for operations during monitoring.

2. Select a station to monitor.

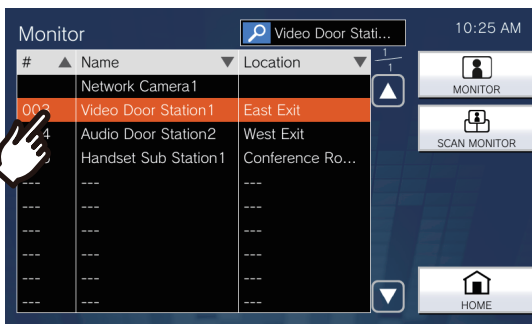

• Refer to (→page 32) for how to search stations.

5. To end monitoring, tap .

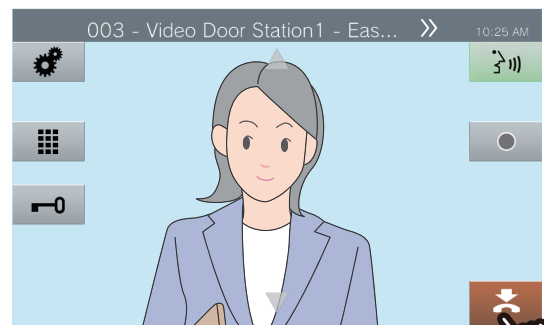

3. Tap **[MONITOR]**.

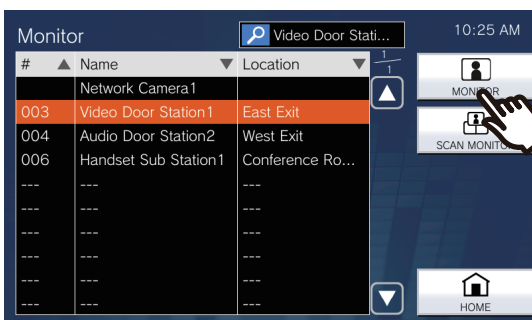



Note

- Tap  or lift the handset during monitoring to initiate a call.
- If the configured Monitor Timeout elapses, monitoring will automatically end. A notification tone will be played approximately 10 seconds prior to monitoring ending. The notification tone may not play, depending on the configuration.
- While monitoring, if this station starts playing a chime or receives a page or receives a call from another station, monitoring will end.

Scan Monitoring

Video and audio of multiple pre-configured stations or network cameras can be monitored, automatically and in order. This function can be configured in [“Monitor Settings \(→page 126\)”](#).

For stations without cameras, only audio monitoring will be performed. IX-MV7-*, IX-MV and VoIP phones cannot be monitored.

Audio of the station that initiates monitoring cannot be heard by the other party during monitoring. However, the other person may be notified that they are being monitored (a notification tone or flashing LED), depending on the configuration of the other station. It may not be possible to monitor the other station when the chime is playing on this station, or when the other station is placing a call, receiving a call, receiving a page, or during communication depending on the settings.

1. Tap **[Monitor]** on the Home screen.

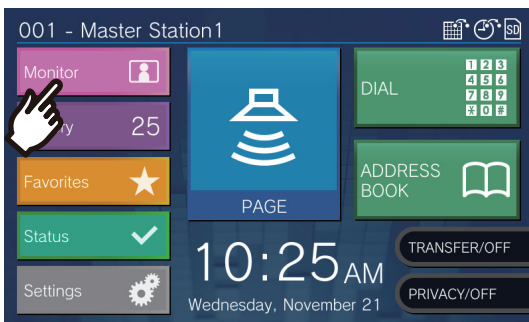

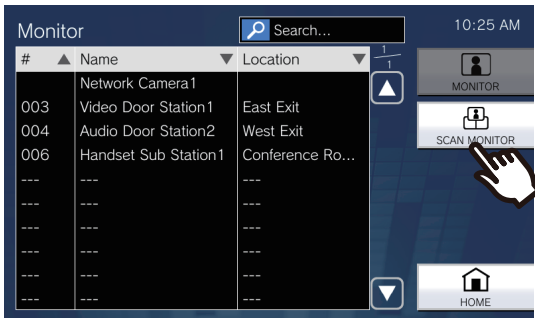

2. Tap **[SCAN MONITOR]**.



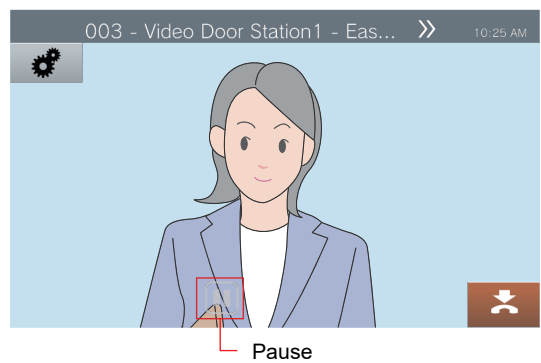

- The calling tone plays until scan monitoring begins.

3. View the video and audio.

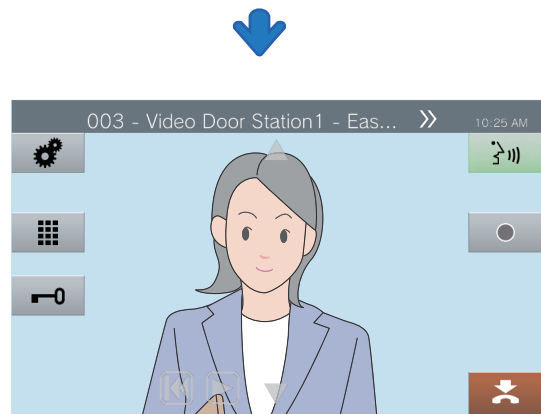

- Tap  to stop automatically switching video and audio. Video and audio from the currently displayed station will continue to be monitored.



- : Press this to switch monitoring to the previous station.
- : Press this to resume scan monitoring.
- Refer to (page 71 and page 75 through page 79) for operations during monitoring.

4. To end Scan Monitoring, tap .

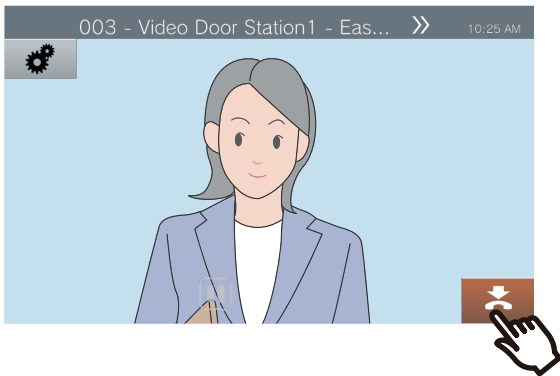

 **Note**

- During scan monitoring, if this station begins playing a chime or receives a page or receives a call from another station, scan monitoring will be paused. When the page, call, or communication ends, scan monitoring will resume from the first station.

Using Speed Dial Buttons

The Speed Dial buttons can be used to quickly perform functions that have been pre-assigned. These functions can be configured in [“Speed Dial Settings \(→page 147\)”](#).

Home Screen 1

Tap **[Favorites]** on the Home Screen to display the Speed Dial buttons.

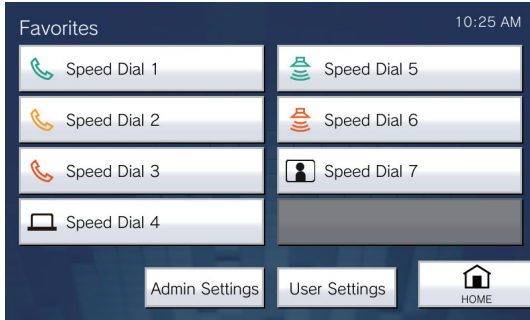

Home Screen 2

The Speed Dial buttons are displayed on the Home Screen.

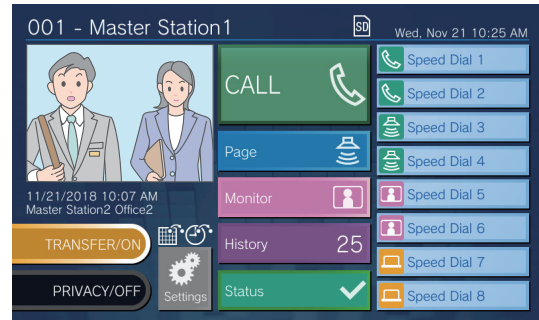

Function icon

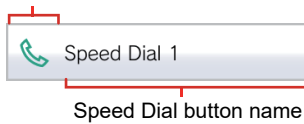

Function icon

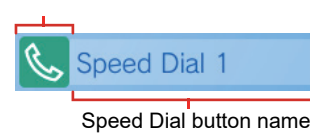

Function icon		Description
Home Screen 1	Home Screen 2	
		Tap to place a normal call to a pre-configured station or group.
		Tap to place a priority call to a pre-configured station or group.
		Tap to place an urgent call to a pre-configured station or group.
		Tap to start a normal page, normal message page, normal all page, or normal all message page to a pre-configured group.
		Tap to start an urgent page, urgent message page, urgent all page, or urgent all message page to a pre-configured group.
		Tap to monitor a pre-configured station or network camera.
		Tap to scan monitor a pre-configured station or network camera.
		Tap to operate relay output for the pre-configured station. During relay control, [Processing...] will be displayed and the button will turn yellow. However, the display and operating state may vary in the following situations. <ul style="list-style-type: none"> Relay output is operated by another station Relay Output was reset by the destination station during Relay Output. When operating relay output for multiple stations at the same time, processing may take some time.

Note

- A VoIP Phone cannot be paged, message paged, monitored, or scan monitored.

Viewing Recordings

Video/audio recordings can be selected from the history to be viewed.

Depending on the configuration, a single video/audio recording may be split into multiple files.

1. Tap **[History]** on the Home screen.

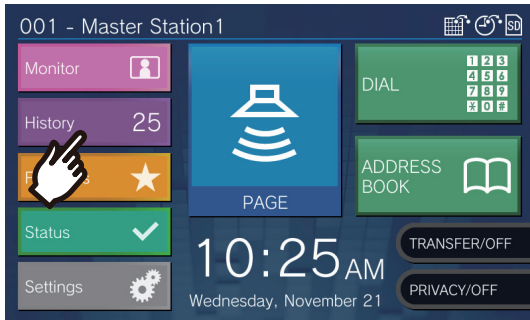

2. Tap **[Recordings]**.

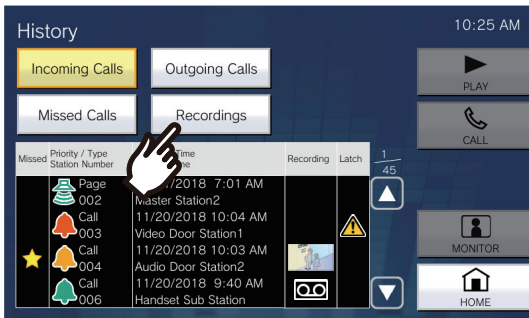

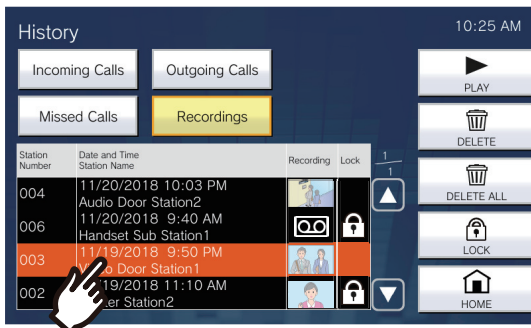

3. Tap the recording to play from the list.

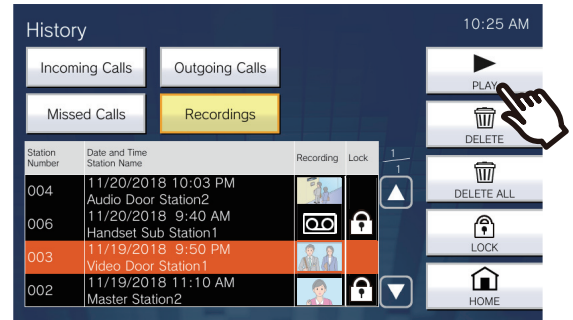

4. Tap **[Play]**.



- **[PLAY]:**
Tap this to play the selected video/audio recording.
- **[DELETE]:**
Tap this to delete the selected video/audio recording.
- **[DELETE ALL]:**
Tap this to delete all video/audio recordings. Protected video/audio recordings cannot be deleted.
- **[LOCK]** (For microSDHC memory cards):
Tap this to protect the selected video/audio recording. Protected content will show  in the protected field and cannot be overwritten or deleted.
- **[UNLOCK]:**
Press this to remove the protection from the selected video/audio recording.

5. Tap  to play the recording.

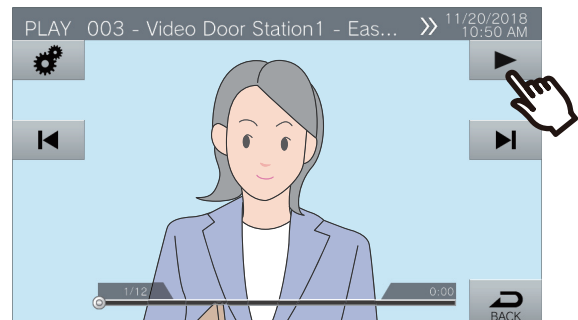

- Refer to ([→page 63](#)) for how to view the screen when playing a recording.



Note

- The station may not be able to play video or audio normally. The recordings may not be saved properly because of the communication.
- Network camera video may not be recorded due to the size of the image.

Understanding the Playback Screen.

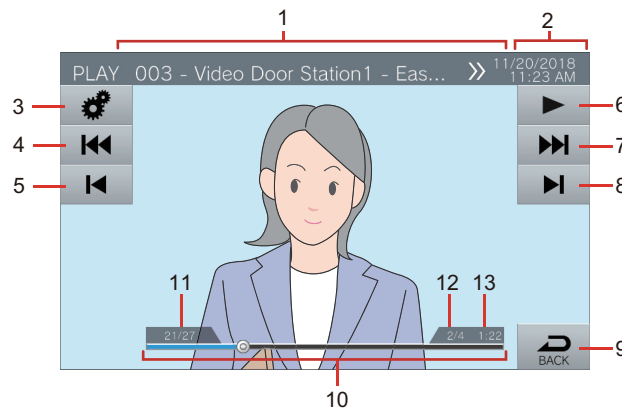

Number	Name	Description
1	Station information	This shows the Station Number, Station Name (Option Input Name), and location of the recorded station.
2	Date and time	This shows the date and time of the recording.
3	Function	Adjust the brightness of the screen and audio volume with this button. : Screen brightness : Playback volume
4	Previous split	Tap this to display the playback screen of the previous split file. is only displayed if the recording file was split. It is not displayed for the first recording split in the series.
5	Previous	Tap this to display the playback screen for the previous recording. Tapping when the first recording is being shown will display the last recording.
6	PLAY/Pause	Play: Tap this to play the recording. Pause: Tap this to pause the recording.
7	Next split	Tap this to display the playback screen for the next split file. is only displayed if the recording was split. It is not displayed for the last recording split in the series.
8	Next	Tap this to display the play screen of the next recording. Tapping when the last recording is being shown will display the first recording.
9	BACK	Tap this to return to the history screen.
10	Seek bar	This shows the playback progress of the recording. Taping the seek bar during playback will play the recording from the point that was tapped. Tapping the seek bar when the recording is paused will show the recording paused at the point that was tapped.
11	Video/audio recording number / total number of recordings	This shows the number of the recording being shown, as well as the total number of recordings.
12	File split number/total number of files	This shows the number of the file being shown and the total number of files. This is displayed when a recording is split into multiple files.
13	Playback time	This shows the playback time.

Play Video/Audio Recordings using a PC

Insert the microSD card the microSD card slot on the PC or a microSD card reader connected to the PC to play video/audio files recorded to the microSD card on the PC.

- Video/audio files (AVI format) can be played using a media player that supports the AVI format.

Note

System for video/audio files saved to microSD cards

- File format: AVI
- File location:
/record
- File name format:

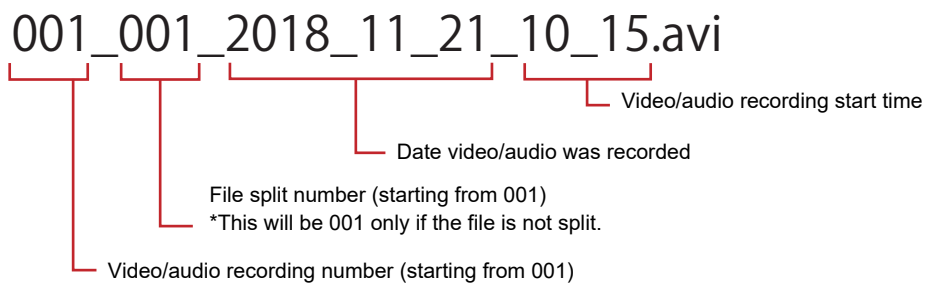

The .png files are thumbnail images for video/audio recording in the history.

Transfer calls (during communication)

A call can be transferred to another station.

Transfer a call

1. Tap  during communication to place the call on hold.

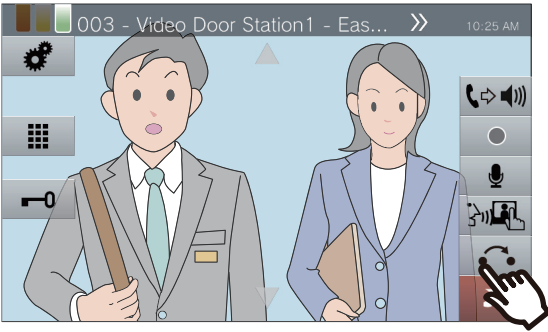

2. Tap the transfer destination station or group.

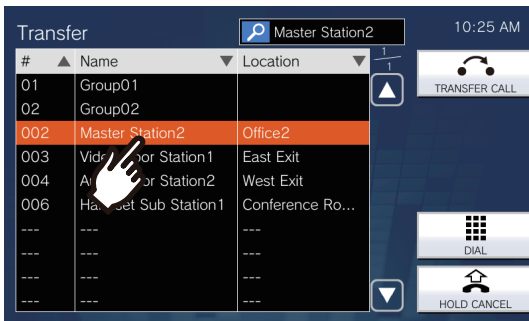

- Refer to ([→page 32](#)) for how to search stations.

3. Tap **[TRANSFER CALL]**.

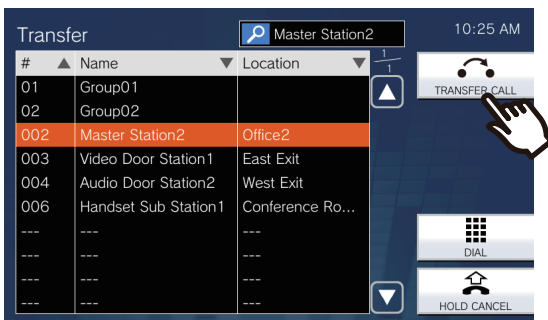

- To take a call off hold, tap **[HOLD CANCEL]**.
- The ringback tone will be heard.

4. Once the transfer destination answers, inform the party that the transfer will be made.

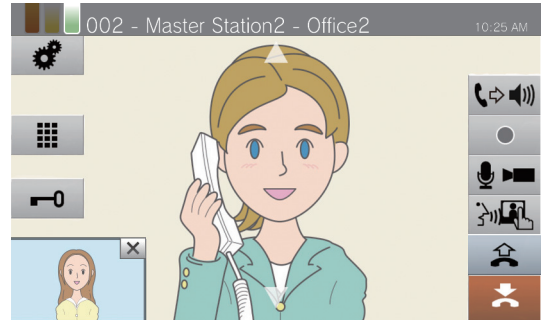

- To cancel transferring, tap .
- For how to view the screen during a call, refer to ([→page 18](#)).
- Refer to ([page 71 through page 80](#)) for operations during a call.

5. Hang up handset or tap .

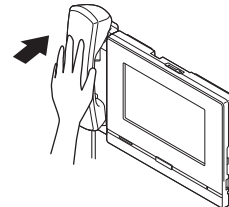

- The call is transferred to the transfer destination.

Note

- It may not be possible to transfer calls, depending on the configuration of the transfer destination station.
- If the transfer destination ends the call first, the communication with the station that placed the call will resume.
- Transferring a call from a station with a camera will transfer the video as well.
- If the transfer destination is a group, the call can be transferred to the first station that answers.
- If the configured call duration with the held station elapses during the call with the transfer destination (if calling a VoIP phone, the duration configured in this station or the VoIP phone, whichever is shorter), the call with the held station will be automatically ended. A notification tone will be played approximately 10 seconds prior to the call ending, but the call cannot be extended. The notification tone may not play, depending on the configuration.
- If transferring is configured on the transfer destination station, the outgoing call will be made according to the configuration.

Receive a transferred call

1. When receiving a call from the transfer source, lift the handset or tap  .

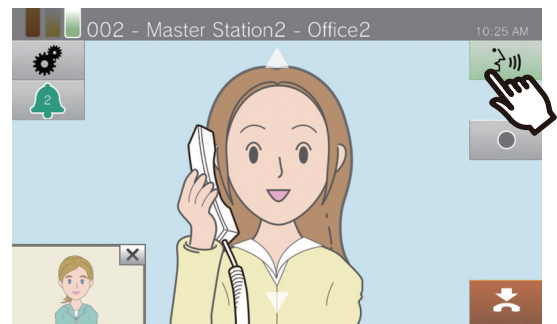
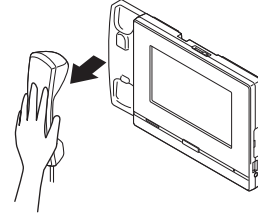

2. Speak with the transferring station.



3. When the transferring station hangs up, the call is transferred and communication can begin.



- For how to view the screen during a call, refer to ([→page 18](#)).
- Refer to ([page 71](#) through [page 80](#)) for operations during a call.



Note

- Transferring a call from a station with a camera will transfer the video as well.
- If communication is ended at the transfer destination before the transferring station, the transfer will not be completed.
- The call will not be automatically answered even if Auto Answer ([→page 110](#)) is set to "ON." Tap  to answer.

Absent Transfer

Activate absent transfer to have incoming calls sent to another station while away. This may not be used depending on administrator settings.

Calls from VoIP phones will be received on this station without being transferred.

Absent transfer

When a call is received while away, the call is automatically transferred to another station.

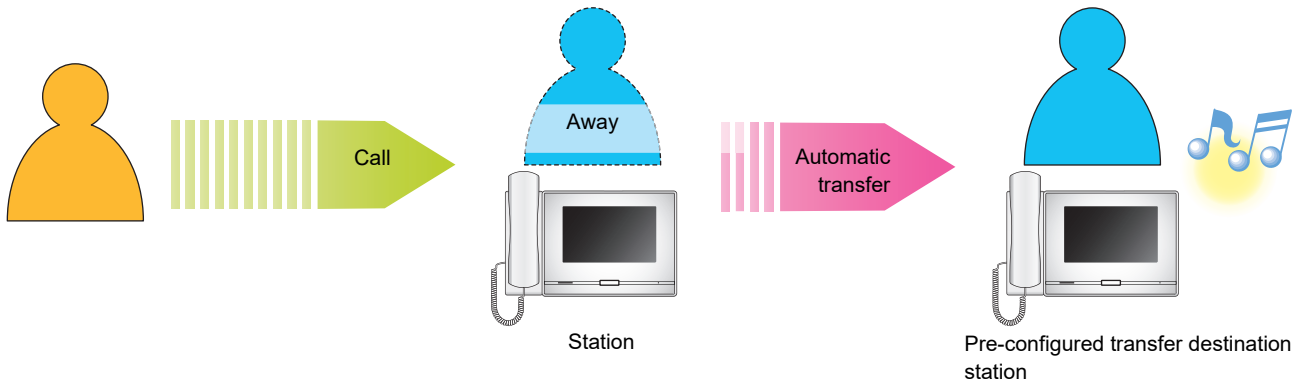

■ Setting absent transfer

1. Tap **[TRANSFER/OFF]** on the Home Screen.

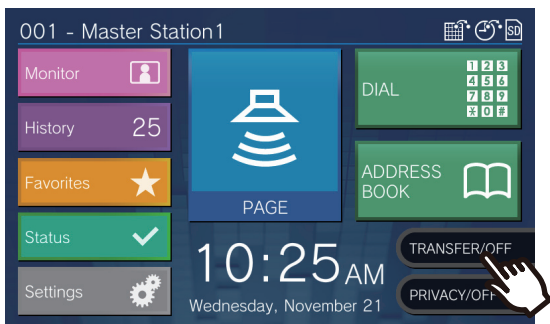

It switches to **[TRANSFER/ON]** and lights up orange.

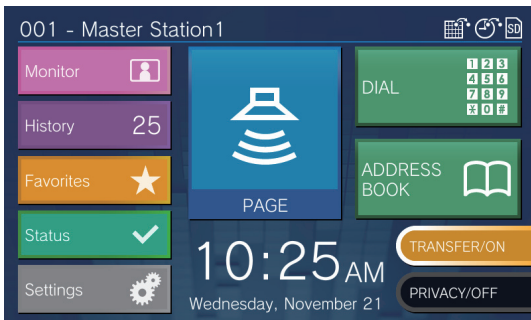

■ Canceling absent transfer

1. Tap **[TRANSFER/ON]** on the Home Screen.

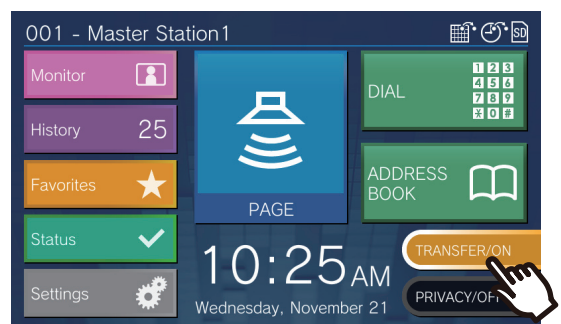

It switches to **[TRANSFER/OFF]** and lights off.

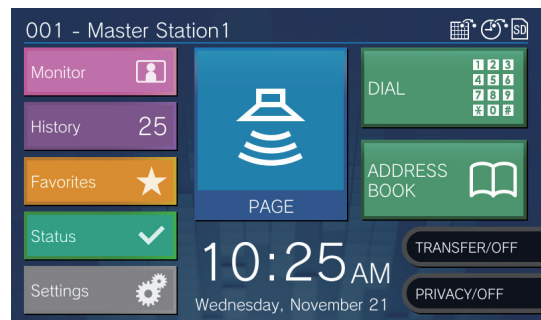



Note

- Absent transfer can also be set via PC ([“Absent Transfer \(→page 115\)”](#)).
- If transfer destinations include a VoIP Phone configured to automatically answer the call, that VoIP Phone will answer.

Other Transfer Options

Incoming calls can be automatically transferred to another station while away. Calls from VoIP phones will arrive on this station without being transferred. Call transfer must be configured in advance, and may be transferred to multiple stations. If a call is transferred to multiple stations, only the first station that answers the call can communicate.

Delayed transfer

Incoming calls can be transferred to another station automatically when not answered within a set period of time. Refer to [“Transfer Settings \(→page 114\)”](#) for how to configure the transfer. While delayed transfer is activated:

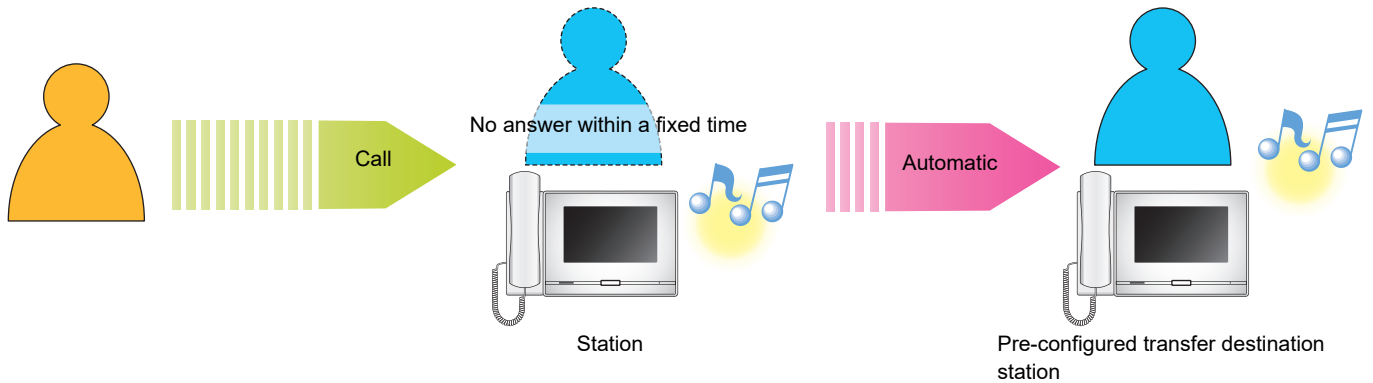

Scheduled transfer

Absent transfer is automatically performed on the pre-configured schedule. Refer to [“Transfer Settings \(→page 114\)”](#) for how to configure the transfer. During scheduled transfer...

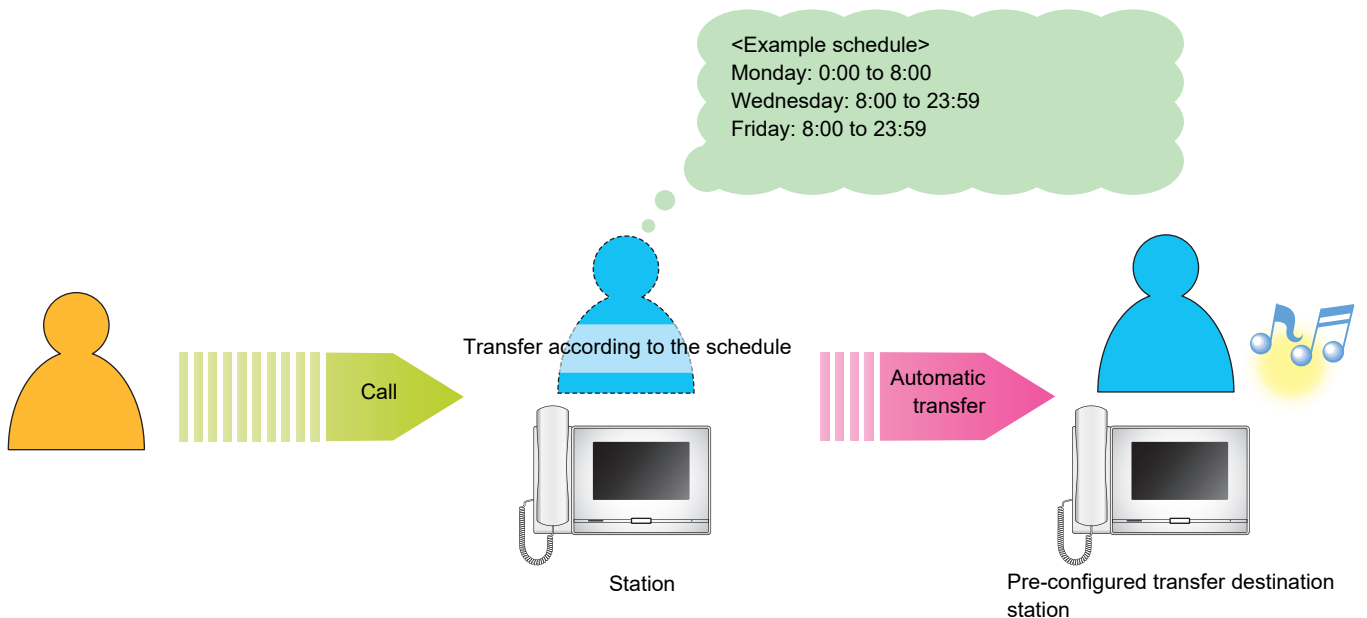

Note

- An icon is displayed on the Home Screen when delay transfer or schedule transfer is configured.
- If transfer destinations include a VoIP Phone configured to automatically answer the call, that VoIP Phone will answer.



Unlocking a door

An electric lock can be released during communication with a station or monitoring a station.

Releasing with the door release button

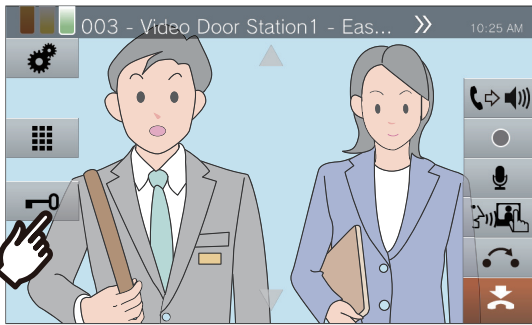
1. Tap  during a call or while monitoring.





- When the door is released,  switches to  for 3 seconds.
- The status indicator of the master station will flash blue when the door is released.

Note

- If the door cannot be released, an error tone will sound.
- Depending on the configuration, tapping the door release button a second time while the door is already released will extend the door release timer.

Releasing with the keypad

Depending on the configuration, the  button may not be displayed.

1. Tap  during a call or during monitoring.

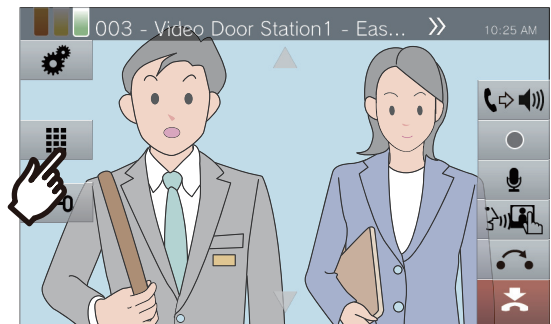

2. Use the keypad to enter **"**authentication key*."**

- If the authentication key is "0000" enter **"**0000*."**





- Tap  to delete the previous character.

3. Tap [ENTER].

- The door unlocks.



- When the door is released,  switches to  for 3 seconds.
- The status indicator of the master station will flash blue when the door is released.

Note

- Depending on the configuration of the station receiving the door release command, a notification tone may be heard when the authentication key is confirmed.
- If the door cannot be released, an error tone will sound.
- Ask the administrator for the authentication key.
- Depending on the configuration, tapping the door release button a second time while the door is already released will extend the door release timer.

Placing a call on hold

When on a call, the call can be put on hold temporarily. The on-hold tone will play on the other station while it is on hold.

1. Tap  during a call.

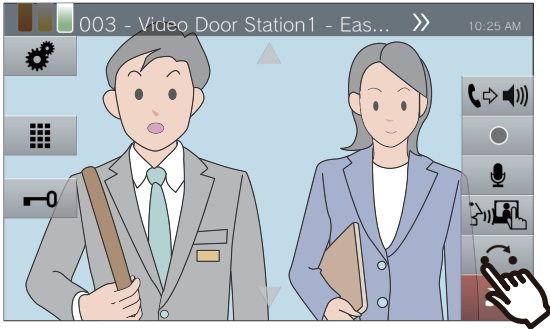

- The call will be placed on hold and the transfer destination search screen is displayed.

2. To resume the call, tap **[HOLD CANCEL]**.

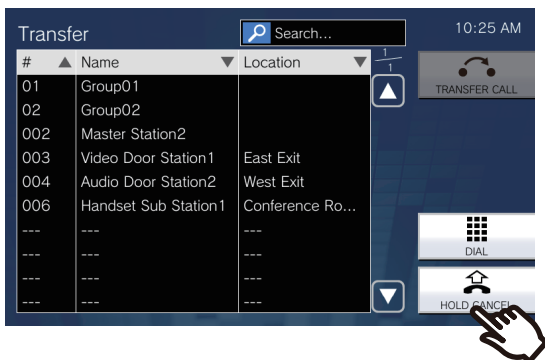

- Resume communication.

Note



- When hang up the handset while the call is on hold, the call will be terminated.
- It is possible to transfer a call while it is on hold. ([→page 65](#))
- The video from the station is not sent to the other station while that station is on hold.

Selecting a station to answer

When receiving multiple incoming calls or receiving an incoming call from another station when placing a call, sending a page, or in communication, you can select which station to answer.

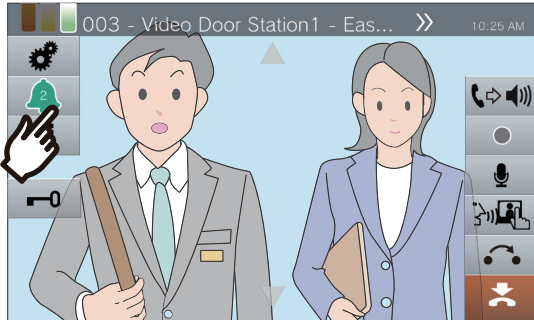
1. Tap  on the screen.



- The color varies according to the priority of the incoming call. If there are multiple incoming calls, the color of the highest priority will be displayed.
- : An urgent call was received.
- : A priority call was received.
- : A normal call was received.

2. Select the station to answer.



3. Lift the handset or tap .

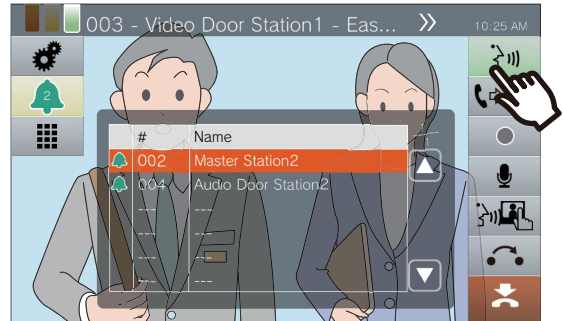
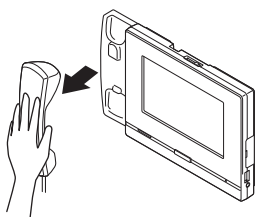

4. Speak with the other party.

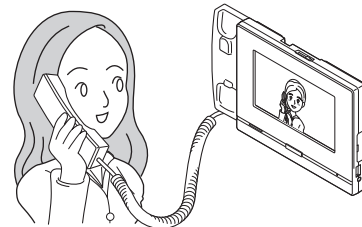

5. To end communication, hang up the handset or tap .

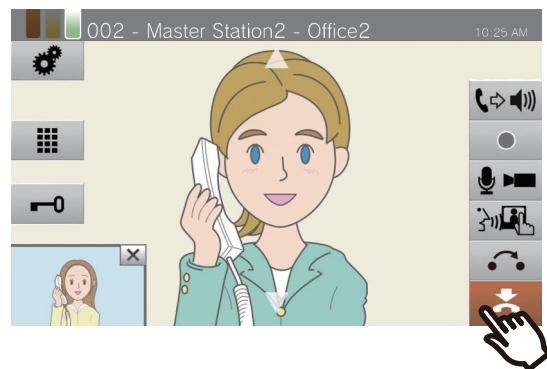
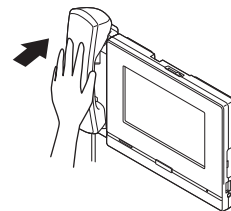

Recording Video / Audio

Video / Audio can be recorded when receiving a call, during communication, and during monitoring. If there is no camera on the station, only audio will be recorded.

Depending on the configuration,  may not be displayed on the screen. In this case, this function cannot be used.

*A microSD card is required for video/audio recording. (microSD card sold separately) ([→page 27](#))

1. Tap  on the screen.

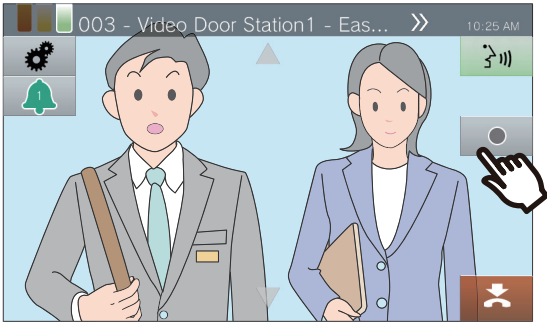

- The icon changes to  and video/audio recording will start.

2. Tap  to end video/audio recording.

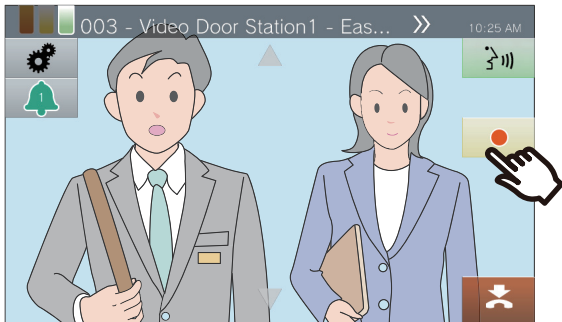

- The icon changes to  and video/audio recording will end.





Note

- When the incoming call, call, or monitoring ends, video/audio recording also ends automatically.
- If overwriting is enabled, the oldest data is overwritten with the newest data if the SDCard becomes full.
- The video of the camera displayed on the monitor will be recorded. However, If video from both a Video Door Station and a network camera are displayed on the LCD display simultaneously, only the video selected in the settings will be recorded.
- During scan monitoring, video/audio can be recorded only when switching between stations is stopped.
- Depending on the configuration, recording will start automatically.
- Depending on the configuration, a single recording may be split into multiple files.
- Depending on the configuration, recording may stop automatically.
-  will not be displayed in the following states.
 - The manual recording function is not permitted, and no auto recording start trigger is configured
 - A microSD card is not inserted
 - There is no free space on the microSD card for recordings
- The network camera may not be able to record video, depending on the size of the video.



Fixing the Capture Area

The capture area of the network camera can be modified.

The capture area may not be able to be adjusted/locked, depending on the network camera configuration.

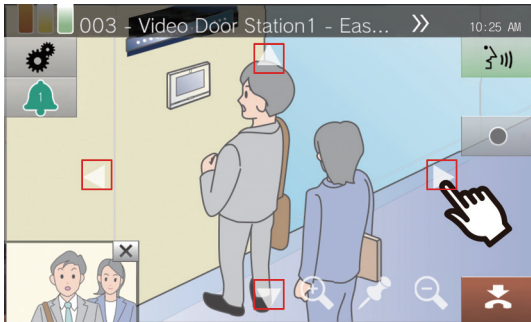
1. When video from a network camera is being displayed, tap , , , and  to adjust the display area horizontally and vertically.



2. Tap  and  to adjust the capture area.

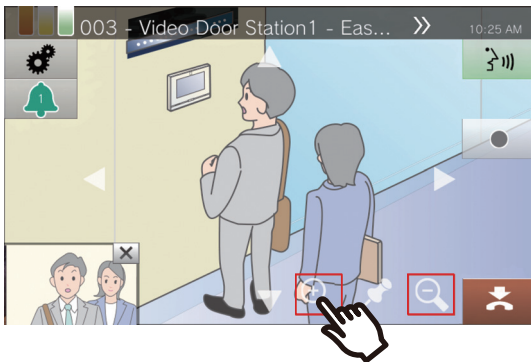

3. Tap .

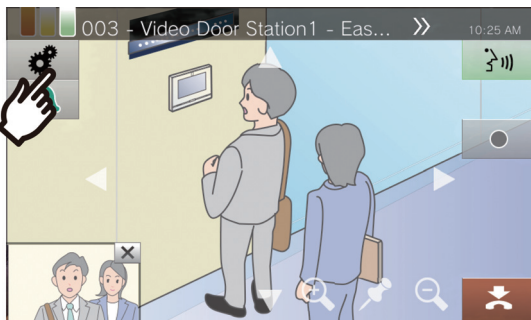

4. Tap **[CAMERA PRESET]** to fix the capture area.

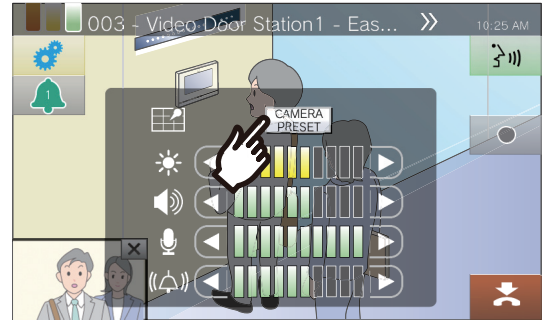

- The setting will be saved.

5. Tap  to return to the previous screen.

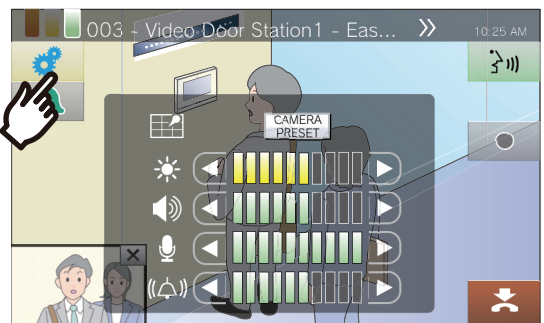

Adjusting video to enhance visibility

Adjust the video displayed by a Video Door Station to enhance visibility.

<When video of a Video Door Station is displayed>

1. Tap .



- The image will be adjusted. A sample is shown below.
- This setting will not be saved.

<Backlight compensation>



Before compensation

<Nighttime compensation>

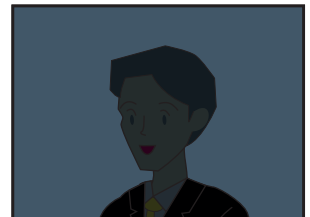

Before compensation



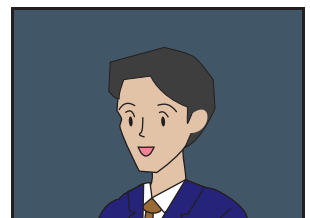

After compensation

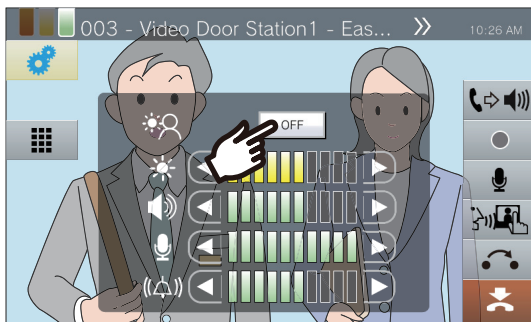

After compensation

2. Tap [OFF].



3. Tap  to return to the previous screen.

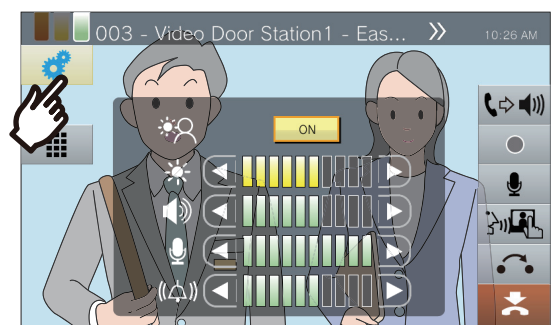

Note



- Press [ON] during compensation to return the image to the state it was in prior to compensation.
- Compensation cannot be applied to video from Master Stations or network cameras.

Adjusting Screen Brightness

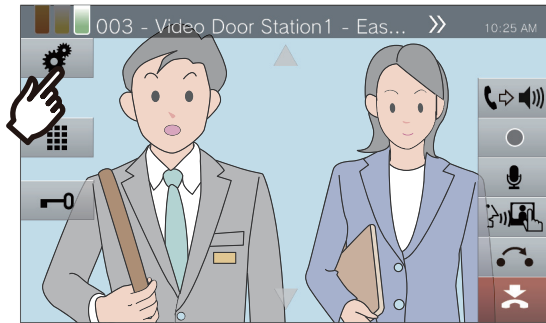

The brightness of the screen can be adjusted when placing a call, receiving an incoming page, during communication, or during (scan) monitoring.

1. Tap .

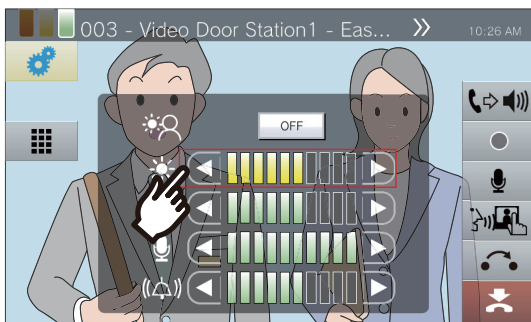

2. Tap  or  to adjust the screen brightness.



- : Press this to darken the screen one step.
- : Press this to lighten the screen one step.
- The setting will be saved.

3. Tap  to return to the previous screen.



Adjusting speaker volume

The receive volume can be adjusted during communication or (scan) monitoring.

1. Tap .

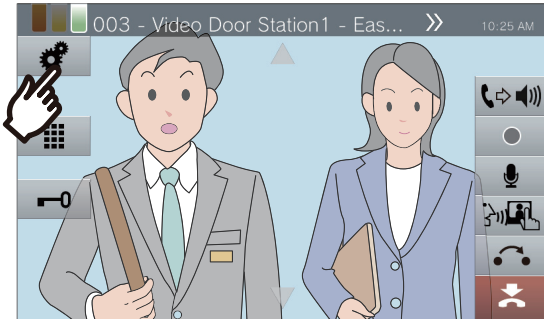



Note

- Adjusting the receive volume will also change the ringback tone volume.
- Adjust the ringback tone volume during an outgoing call.

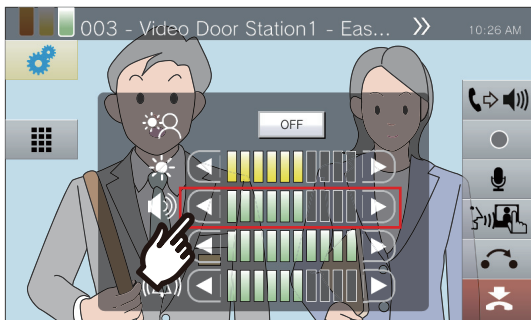
2. Tap  or  to adjust the receive volume.



- :
Press this to decrease one step.
- :
Press this to increase one step.
- The setting will be saved.

3. Tap  to return to the previous screen.

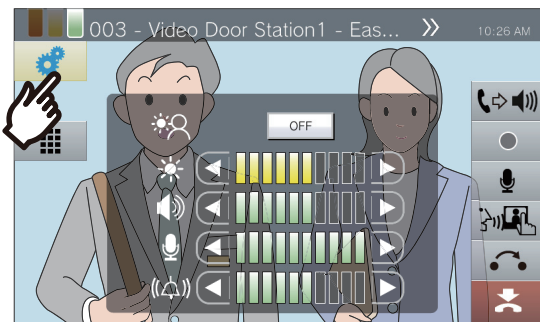



Adjusting microphone volume

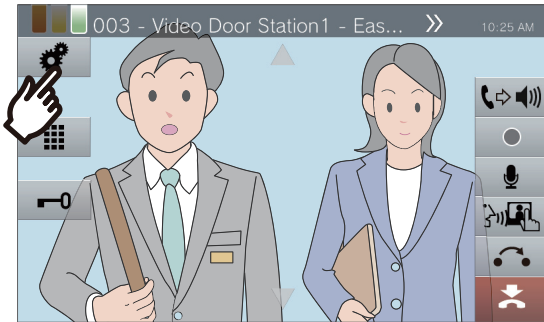

The microphone volume can be adjusted during communication or when sending a page.

1. Tap .

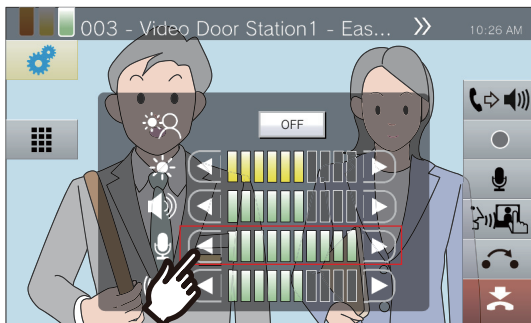

2. Tap  or  to adjust the microphone volume.



- : Press this to decrease one step.
- : Press this to increase one step.
- The setting will be saved.

3. Tap  to return to the previous screen.

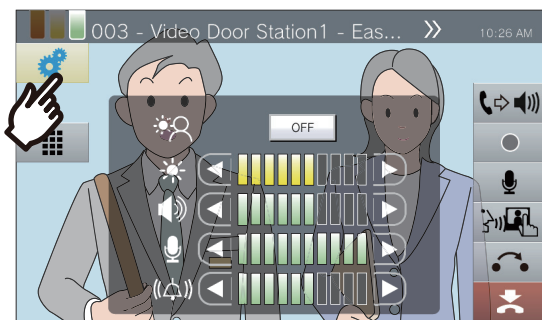



Adjusting Ringtone Volume

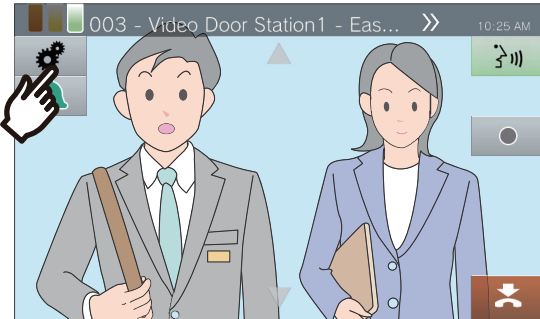

The ringtone volume can be adjusted during an incoming call or when receiving a page.

1. Tap .

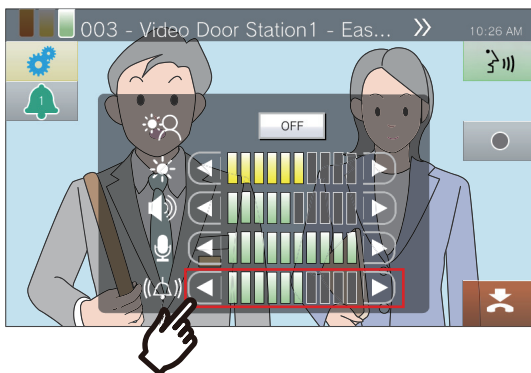

2. Tap  or  to adjust the ringtone volume.



- : Press this to decrease one step.
- : Press this to increase one step.
- The setting will be saved.

3. Tap  to return to the previous screen.

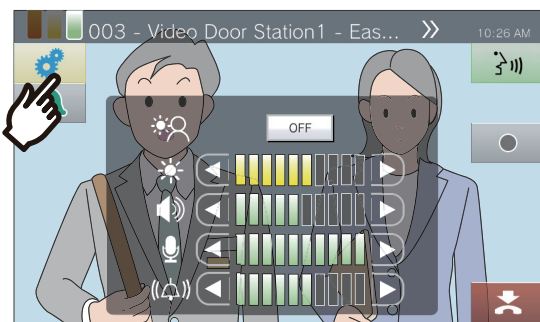

Using Line Supervision

Check a network communication between this station and stations other than VoIP phones registered in this station's Address Book.

Network communication can also be automatically checked on a periodic basis ([“Supervision Settings \(administrator privileges only\)”](#) (→page 158)).

Line Supervision results are also stored on the microSD card.

Performing manual line Supervision

1. Tap **[Status]** on the Home screen.

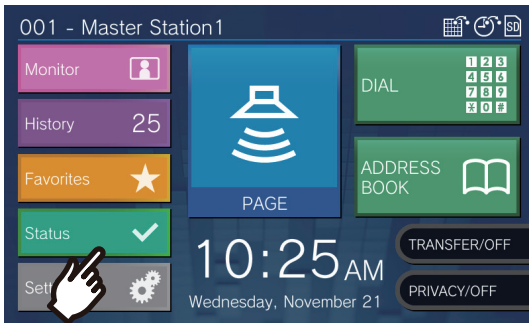

2. Tap **[Line Supervision]**.

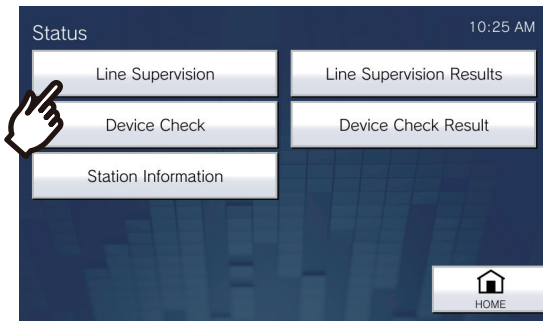

3. Enter the administrator password, and then tap **[ENTER]**.

This password is the same as the administrator password for Web configuration. Contact your system administrator for details.

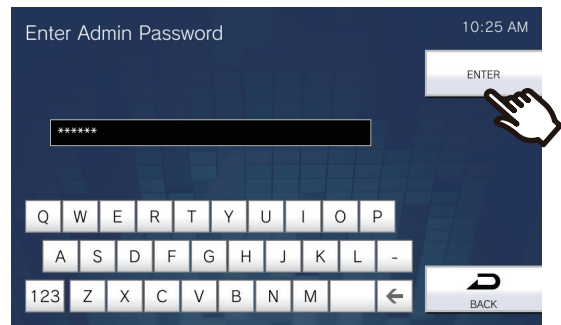

- Once line Supervision begins, the screen returns to the Status screen.

If an error was detected, **[Status]** on the Home screen turns from green to red.

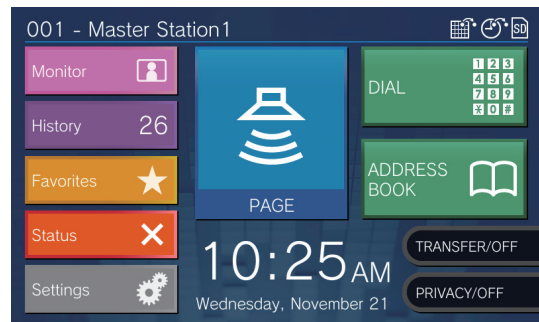

Reviewing an error

1. Tap **[Status]** on the Home screen.

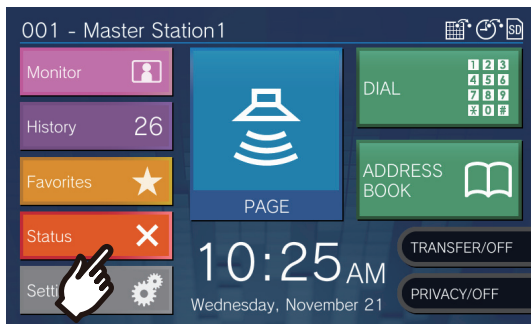

2. Tap **[Line Supervision Results]**.

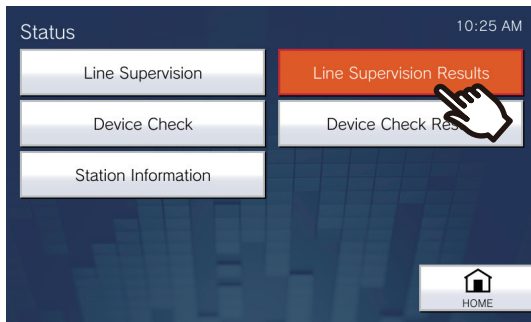

3. Check the station that has a network communication error.

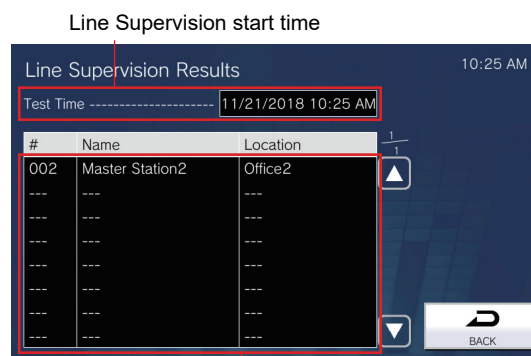

Station that has a network communication error.

4. Resolve the error and perform line monitoring again.

- If the error has been resolved, **[Status]** on the Home screen will change back from red to green.



Note

- Errors will be detected even if the network itself is healthy and there is a malfunction in the other station.

Performing Device Check

Check malfunctions for speaker, microphone, program, call button and option input of the stations that are registered in this station's Address Book (except VoIP phones).

IX-MV, IX-DA, and IX-BA can be checked only for program malfunctions.

It is not possible to check for network camera malfunctions.

Malfunctions can also be automatically checked on a periodic basis ([“Supervision Settings \(administrator privileges only\) \(→page 158\)”](#)).

Device Check results are also stored on the microSD card.

! Important

- Stations that cannot communicate cannot be checked for malfunctions. Use this function together with Line Supervision.

Performing manual Device Check

1. Tap **[Status]** on the Home screen.

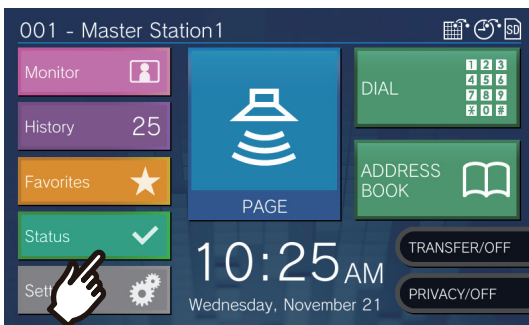

2. Tap **[Device Check]**.

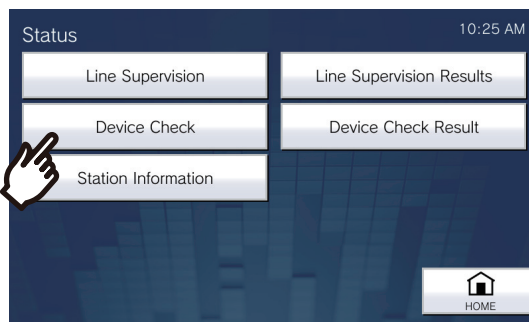

3. Enter the administrator password, and then tap **[ENTER]**.

This password is the same as the administrator password for Web configuration. Contact your system administrator for details.

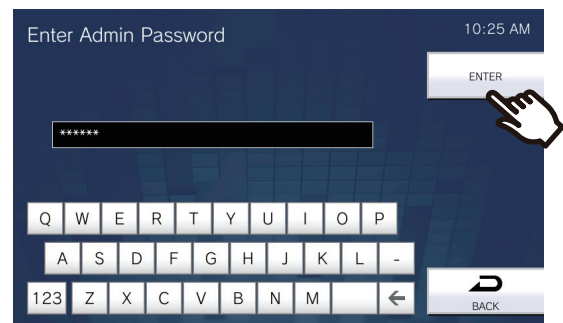

- A short beep will be heard from each station, in order to check for speaker/microphone malfunctions.
- Once malfunction monitoring begins, the screen returns to the Status screen.

If an error was detected, **[Status]** on the Home screen turns from green to red.

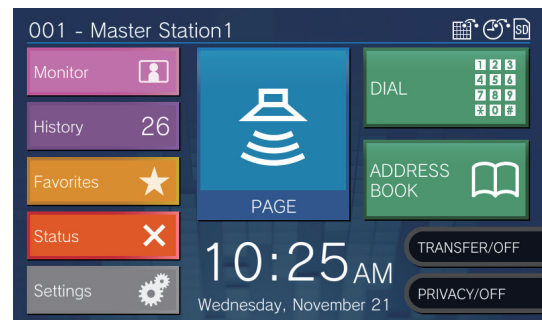

If an error is detected

1. Tap **[Status]** on the Home screen.

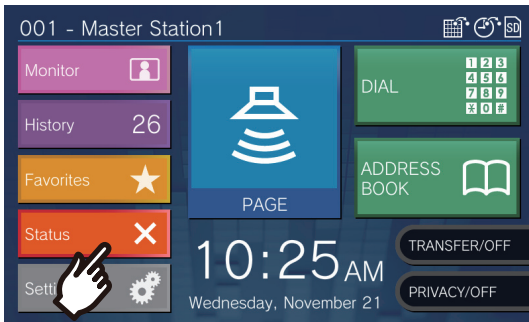

2. Tap **[Device Check Results]**.

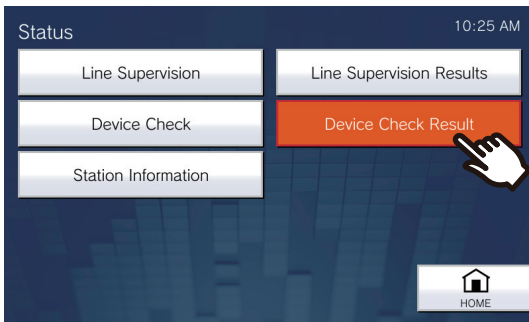

3. Check the station that has an error.

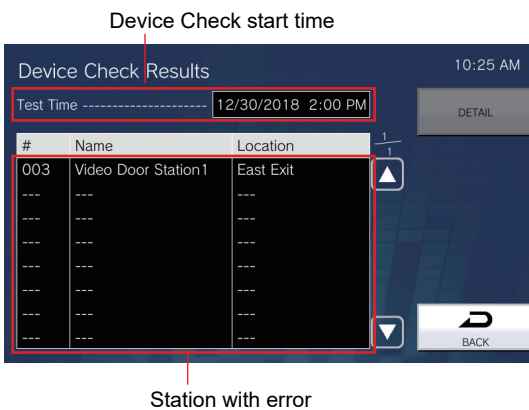

4. Select the station to check details of the malfunction.

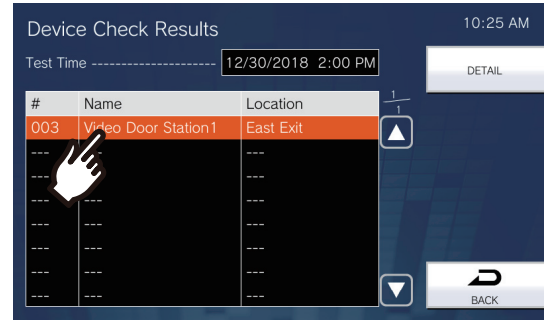

5. Tap **[DETAIL]**.

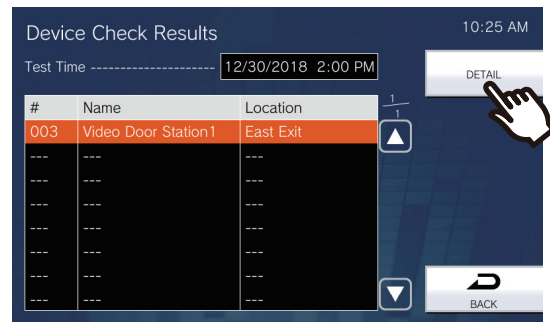

- : Normal.
- : Error.

6. Resolve the error and perform Device Check again.

- If the error has been resolved, **[Status]** on the Home screen will change back from red to green.

Confirming Station Information

The firmware version and network configuration information of this station can be checked.

1. Tap **[Status]** on the Home screen.

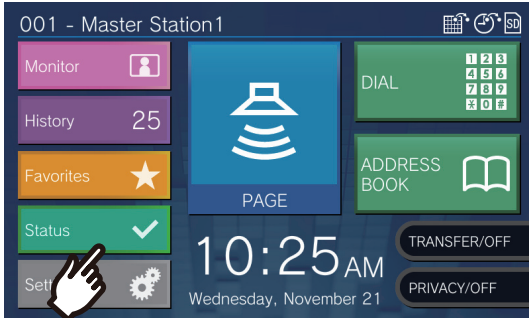

2. Tap **[Station Information]**.

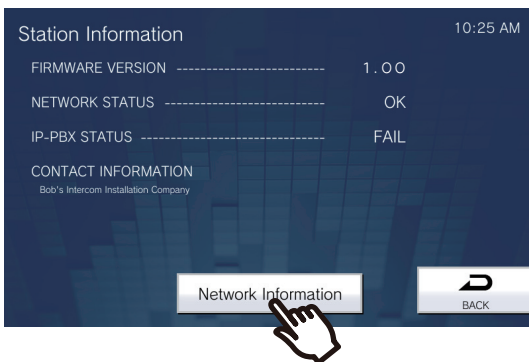
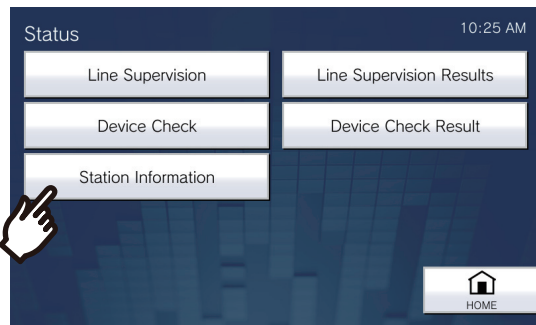

- **FIRMWARE VERSION:** This shows the firmware version of this station.
- **NETWORK STATUS:** This shows whether this station is connected properly to the network.
- **IP-PBX STATUS:** This shows the connection status with the IP-PBX.

- **CONTACT INFORMATION:** This shows information on the installer configured in the IX Support Tool configuration tool.

3. Tap **[Network Information]**.

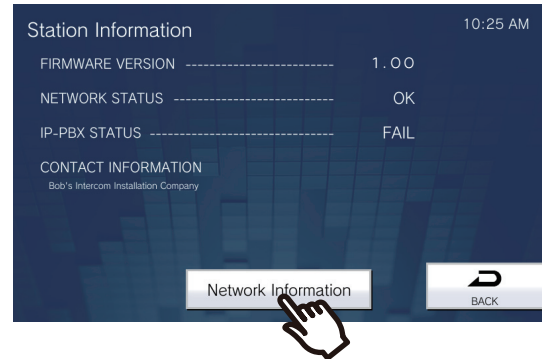

4. Enter the administrator password, and then tap **[ENTER]**.

This password is the same as the administrator password for web configuration. Contact your system administrator for details.

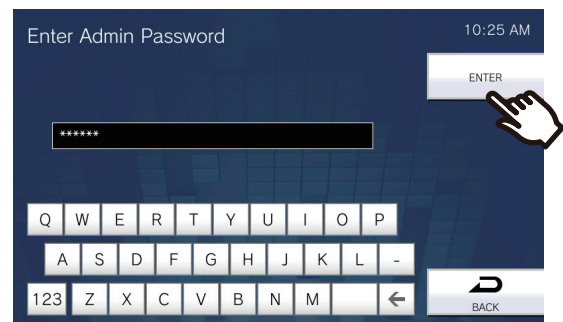

5. Check the network information for this station.

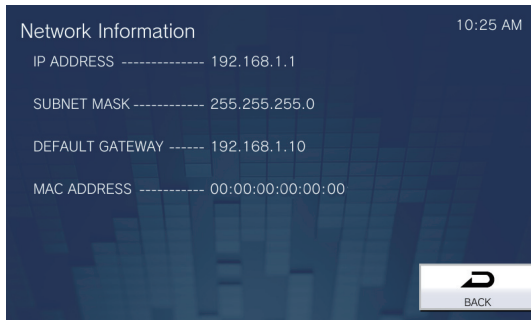

- Tap **[BACK]** to return to the **[Station Information]** screen.
-

Configuring the station sound a tone on a schedule

Configure the station to play a chime tone on the configured schedule.
Refer to "[Chime Settings \(→page 130\)](#)" for configuring chimes.



Note

- If a call or page is received while the chime is playing, the chime will be canceled.
- The chime will not play when placing a call, receiving a call, during paging, or communication.

Playing the Communication Audio Messages automatically

A message to help identify the location of the other station can be automatically played when a call starts or via keypad input.

The Communication Audio Messages can be used if it is registered to the other station.

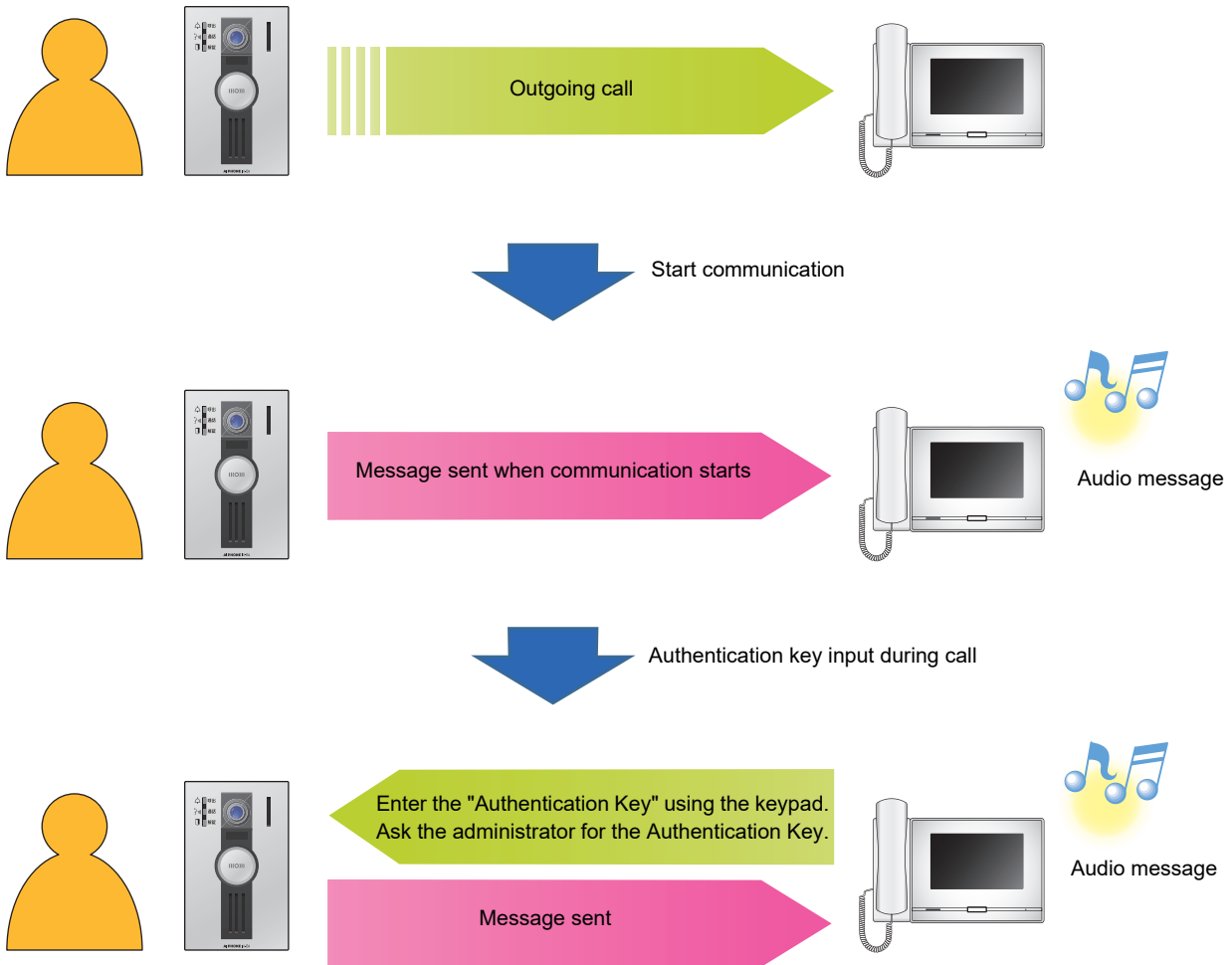

Sending an email

An email can be sent to pre-registered email addresses using Email Event Trigger. For how to configure email settings, refer to [“Email \(→page 186\)”](#).

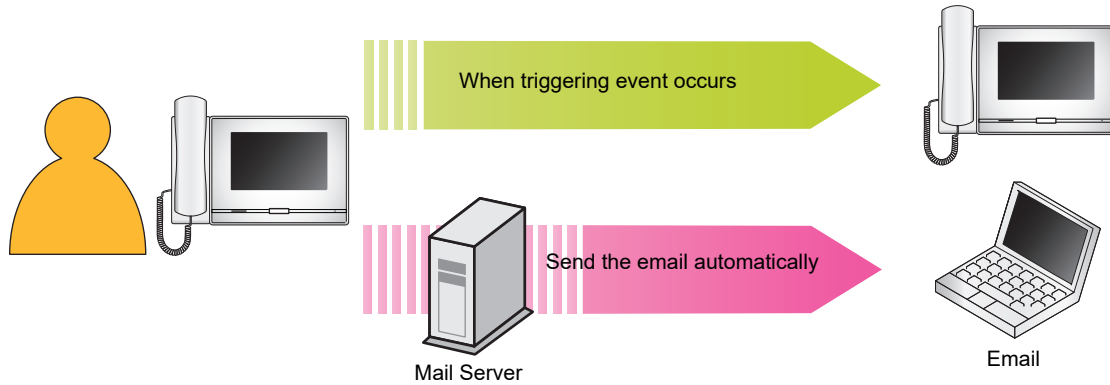

Example of sending email:

When placing a call to the Door Station 3 (Station Number: 003, Station Name: Door Station 3, Location: Reception desk) from this station (Station Number: 002, Station Name: Intercom Station 2, Location: Fire Prevention Center) with the "Priority" priority.

Source	△△△△@△△△△△.com
Date and time	11/20/2018 7:22
To CC	xxxxx@xxxxxx.com
Subject	002 Intercom Station 2 Priority Outgoing Call
Description	<p>A call was made at [20181120 07:21:00].</p> <p>Source Station Number: [002] Source Station Name: [Intercom Station 2] Source Station Location: [Fire Prevention Center] Call Priority: [Priority] Destination Station Number: [003] Destination Station Name: [Door Station 3] Destination Station Location: [Reception desk]</p>

Note

- "UTF-8" is used to encode the "Subject." Characters may display incorrectly depending on the email client. To avoid this, set the encoding method to "UTF-8."

Settings

Configure the settings in either of the following methods.

- Configure on the station.
Some settings can be configured using the buttons on this station.
- Configure using a PC
Access to the station from a PC to configure most of the setting items.

Contact the system administrator for information on configuring administrator privileges.

■ Settings on the station

Entry	Reference page	Settings when using a PC	
		Entry	Reference page
Station			
Language	page 101	-	-
Date and Time			
DATE (YYYY/MM/DD)	page 103	Date and Time	page 168
TIME (24 HR)	page 103		
DAYLIGHT SAVINGS TIME	page 103	Daylight Savings Time	page 168
Time Zone	page 103	Time Zone	page 168
STATUS LED IN STANDBY	page 101	Standby LED State	page 224
SCREEN BRIGHTNESS	page 101	Brightness	page 224
Display Clean Mode	page 101	-	-
Call			
Outgoing Call Setting 1 - Call Timer			
CALL BUTTON	page 104	Call Timeout (Call Button)	page 174
OPTION INPUT 1-4	page 104	Call Timeout (Option Input 1 - 4)	page 175
Outgoing Call Setting 2 - Ringback Tone			
Call Button			
PLAY COUNT	page 106	Ringback Tone Count [time(s)] (Call Button)	page 175
Ringback Tone	page 106	Ringback Tone (Call Button)	page 174
Option Input 1 - 4			
PLAY COUNT	page 106	Ringback Tone Count [time(s)] (Option Input 1-4)	page 175
Ringback Tone	page 106	Ringback Tone (Option Input 1-4)	page 175
Incoming Call Setting 1 - Ringtone Count			
CALL BUTTON	page 107	Call Button Ringtone Count [time(s)]	page 178
OPTION INPUT	page 107	Option Input Ringtone Count [time(s)]	page 178
Incoming Call Setting 2 - Ringtone			
Call Button	page 109	Call Button	page 178
Option Input	page 109	Option Input	page 178
Incoming Call Setting 3			
AUTO ANSWER	page 110	Auto Answer	page 177

Entry	Reference page	Settings when using a PC	
		Entry	Reference page
Communication			
COMMUNICATION TIMER	page 113	Talk Timeout [sec]	page 222
FORCE TOUCH-TO-TALK	page 113	Force Touch-to-Talk	page 222
Transfer^{*1}			
Absent Transfer ^{*1}	page 114	Absent Transfer ^{*1}	page 204
Absent Transfer Settings ^{*1}	page 116	Transfer Destination List ^{*1}	page 204
		Re-Transfer Destination ^{*1}	page 205
Delay Transfer ^{*1}	page 114	Delay Transfer ^{*1}	page 205
Delay Transfer Settings ^{*1}	page 117	Transfer Destination List ^{*1}	page 206
		Re-Transfer Destination ^{*1}	page 206
DELAY TIMER ^{*1}	page 117	Delay Time [sec] ^{*1}	page 205
Schedule Transfer ^{*1}	page 115	Schedule Transfer ^{*1}	page 207
Daily Schedule ^{*1}	page 119	Daily Schedule ^{*1}	page 209
WEEKLY SETTINGS ^{*1}	page 122	Weekly Schedule ^{*1}	page 207
LOCK TRANSFER SETTINGS ^{*2}	page 115	Lock ^{*2}	-
Page			
PAGE TIMER	page 125	Paging Timeout [sec]	page 182
URGENT PAGE RESPONSE ^{*2}	page 125	Urgent Page Response ^{*2}	-
Monitor			
MONITOR TIMER	page 126	Monitor Timeout [sec]	page 224
SCAN MONITOR DWELL TIME	page 126	Dwell Time	page 224
Scan Monitor Settings	page 126	Station / Network Camera List	page 224
Record			
MANUAL RECORD	page 129	Manual Recording	page 192
TRIGGER EVENT	page 129	Record Event	page 191
RECORD TIMER	page 129	Event Recording Timer	page 192
PREVENT OVERWRITE	page 129	Prevent Overwrite	page 191
Chime			
Daily Schedule	page 131	Daily Schedule	page 194
WEEKLY SETTINGS	page 133	Weekly Schedule	page 193
Relay Output^{*2}			
Relay Output 1^{*2}			
FUNCTION ^{*2}	page 137	Function ^{*2}	-
OPTION RELAY CONTROL ^{*2}	page 137	Option Relay Control ^{*2}	-
Relay Output 2^{*2}			
FUNCTION ^{*2}	page 137	Function ^{*2}	-
OPTION RELAY CONTROL ^{*2}	page 137	Option Relay Control ^{*2}	-

Entry	Reference page	Settings when using a PC	
		Entry	Reference page
Relay Output 1 Schedule*²			
Daily Schedule* ²	page 141	Daily Schedule* ²	-
WEEKLY SETTINGS* ²	page 143	Weekly Schedule* ²	-
Relay Output 2 Schedule*²			
Daily Schedule* ²	page 141	Daily Schedule* ²	-
WEEKLY SETTINGS* ²	page 143	Weekly Schedule* ²	-
Volume			
HANDS-FREE RECEIVE	page 145	Hands-free Receive	page 217
HANDS-FREE TRANSMIT	page 145	Hands-free Transmit	page 217
HANDSET RECEIVE	page 145	Handset Receive	page 217
HANDSET TRANSMIT	page 145	Handset Transmit	page 217
HEADSET JACK RECEIVE	page 146	Headset Jack Receive	page 217
HEADSET JACK TRANSMIT	page 146	Headset Jack Transmit	page 217
RINGTONE	page 146	Ringtone	page 218
BUTTON FEEDBACK	page 146	Button Feedback	page 218
Speed Dial			
Favorites 1 to 8* ³	page 147	Speed Dial # * ³	page 211
Supervision*²			
LINE SUPERVISION INTERVAL* ²	page 159	Line Supervision Interval* ²	-
LINE SUPERVISION SCHEDULE* ²	page 159	Line Supervision Schedule* ²	-
DEVICE CHECK INTERVAL* ²	page 159	Device Check Interval* ²	-
DEVICE CHECK SCHEDULE* ²	page 159	Device Check Schedule* ²	-
Factory Reset			
Default User Settings	page 160	Initialize User Settings	page 225
Factory Reset* ²	page 161	Initialization* ²	page 225

*1 This is an administrator privileges setting. If "LOCK TRANSFER SETTINGS" is set to "OFF," this may be configured even with user privileges.

*2 This can be configured or run under administrator privileges only.

*3 This is an administrator privileges setting. If "Lock" is set to "OFF," this may be configured even with user privileges.

■ Settings using a PC

Entry	Reference page	If configured on this station	
		Entry	Reference page
Station Information			
ID and Password			
User ID	page 167	-	-
User Password	page 167	-	-
Language			
Language	page 167	-	-
Time			

Entry	Reference page	If configured on this station	
		Entry	Reference page
Time Zone			
Select time zone	page 168	Time Zone	page 103
Daylight Savings Time			
Enable automatic daylight savings time	page 168	DAYLIGHT SAVINGS TIME	page 103
Date and Time			
Set date and time	page 169	DATE (YYYY/MM/DD)	page 103
		TIME (24 HR)	page 103
Network Settings			
Video			
Master Station Video Setting			
Video Streaming	page 170	-	-
Frame Rate [fps]	page 170	-	-
Select Profile	page 170	-	-
I-picture interval	page 170	-	-
Bit Rate [kbps] [H.264/AVC]	page 170	-	-
NTP			
Enable NTP	page 171	-	-
System Information			
Custom Sound Registry	page 172	-	-
Call Settings			
Call Origination			
Call Origination Settings			
Call Button			
Ringback Tone	page 174	Ringback Tone	page 106
Call Timeout	page 174	CALL BUTTON	page 104
Ringback Tone Count [time(s)]	page 175	PLAY COUNT	page 106
Option Input 1- 4			
Ringback Tone	page 175	Ringback Tone	page 106
Call Timeout	page 175	Option Input 1-4	page 104
Ringback Tone Count [time(s)]	page 175	PLAY COUNT	page 106
Call Destination	page 175	-	-
Priority	page 175	-	-
Tone Settings			
Busy Tone	page 176	-	-
Incoming Call			
Call Answer Settings			
Auto Answer	page 177	AUTO ANSWER	page 110
Ringtone			
Call Button	page 178	Call Button	page 109
Option Input	page 178	Option Input	page 109
Call Button Ringtone Count [time(s)]	page 178	CALL BUTTON	page 107

Entry		Reference page	If configured on this station	
			Entry	Reference page
	Option Input Ringtone Count [time(s)]	page 178	OPTION INPUT	page 107
	VoIP Phone	page 179	-	-
Option Input / Relay Output Settings				
Relay Output				
Output terminal advanced settings				
	Authentication Key	page 180	-	-
	Sound Settings	page 181	-	-
	Option Relay Control Authentication Key	page 181	-	-
Paging Settings				
Paging Origination				
	Paging Timeout [sec]	page 182	PAGE TIMER	page 125
	Paging Wait Timer [sec]	page 182	-	-
Option Input Page				
	Destination	page 183	-	-
	Priority	page 183	-	-
	Message File Name	page 183	-	-
	Play Count [time(s)]	page 183	-	-
Function Settings				
Door Release				
Door Release Assignment				
	Contact Assignment	page 184	-	-
	Authentication Key	page 184	-	-
Network Camera Integration				
Event Registration				
	Event Tone	page 185	-	-
	Play count of Event Tone	page 185	-	-
Email				
Email Addresses				
	Destination 1 - Destination 3	page 186	-	-
Email Event Trigger				
	Outgoing Normal Call	page 187	-	-
	Incoming Normal Call	page 187	-	-
	Outgoing Priority Call	page 187	-	-
	Incoming Priority Call	page 187	-	-
	Outgoing Urgent Call	page 187	-	-
	Incoming Urgent Call	page 187	-	-
	Door Release Activated	page 188	-	-
	Call Failed	page 188	-	-
	Error	page 188	-	-
	Station Restarted	page 188	-	-

Entry	Reference page	If configured on this station	
		Entry	Reference page
SD Card Error	page 188	-	-
Recording Memory Full	page 188	-	-
Line Supervision (Passed)	page 188	-	-
Line Supervision (Failed)	page 188	-	-
Device Check (Passed)	page 188	-	-
Device Check (Failed)	page 188	-	-
Subject	page 188	-	-
Periodic Log Transmission			
Periodic Log Transmission	page 189	-	-
Periodic Log Transmit Time	page 189	-	-
Periodic Log Transmit Interval	page 189	-	-
Periodic Log Transmission Subject	page 189	-	-
Send Test Email	page 190	-	-
Record			
Record Event	page 191	TRIGGER EVENT	page 129
Recorded Device	page 191	-	-
Prevent Overwrite	page 191	PREVENT OVERWRITE	page 129
Video Recording File Length	page 191	-	-
Event Recording Timer	page 192	RECORD TIMER	page 129
Manual Recording	page 192	MANUAL RECORD	page 129
Audio Recording	page 192	-	-
Chime			
Weekly Schedule	page 193	WEEKLY SETTINGS	page 133
Daily Schedule	page 194	Daily Schedule	page 131
Display Mode			
Standard Mode			
Home Screen	page 196	-	-
Receptionist Mode			
Color Scheme	page 197	-	-
Screen Layout	page 197	-	-
Company Information			
Name	page 200	-	-
Text Size	page 200	-	-
Bold	page 200	-	-
Text Color	page 200	-	-
Greeting Information			
Greeting	page 200	-	-
Text Size	page 200	-	-
Bold	page 200	-	-
Text Color	page 201	-	-

Entry	Reference page	If configured on this station	
		Entry	Reference page
Images	page 201	-	-
Company Image	page 201	-	-
Greeting Image	page 201	-	-
Receptionist Image	page 201	-	-
Button Function	page 202	-	-
Button 1- 4	page 202	-	-
Button Name for Group Call	page 203	-	-
Button Name for Select By Name	page 203	-	-
Button Name for Select By List	page 203	-	-
Button Name for Enter Number	page 203	-	-
Group Call Destination	page 203	-	-
Reject Incoming Call	page 203	-	-
Transfer Settings*¹			
Absent Transfer*¹			
Absent Transfer* ¹	page 204	Absent Transfer* ¹	page 115
Transfer Destination List* ¹			
Station Number* ¹	page 204	Absent Transfer Settings* ¹	page 116
Re-Transfer Destination* ¹	page 205		
Delay Transfer*¹			
Delay Transfer* ¹	page 205	Delay Transfer* ¹	page 115
Delay Time [sec]* ¹	page 206	DELAY TIMER* ¹	page 118
Transfer Destination List* ¹			
Station Number* ¹	page 206	Delay Transfer Settings* ¹	page 117
Re-Transfer Destination* ¹	page 206		
Schedule Transfer*¹			
Schedule Transfer* ¹	page 207	Schedule Transfer* ¹	page 115
Weekly Schedule* ¹	page 207	WEEKLY SETTINGS* ¹	page 122
Daily Schedule* ¹	page 209	Daily Schedule* ¹	page 119
Station Settings			
Speed Dial # *²			
Speed Dial Name* ²	page 213	Speed Dial* ²	page 147
Function* ²	page 213		
Privacy			
Privacy	page 217	-	-
Volume / Tone			
Volume			
Handset Transmit	page 217	HANDSET TRANSMIT	page 145
Handset Receive	page 217	HANDSET RECEIVE	page 145
Hands-free Transmit	page 217	HANDS-FREE TRANSMIT	page 145
Hands-free Receive	page 217	HANDS-FREE RECEIVE	page 145

Entry	Reference page	If configured on this station	
		Entry	Reference page
Headset Jack Transmit	page 217	HEADSET JACK TRANSMIT	page 146
Headset Jack Receive	page 217	HEADSET JACK RECEIVE	page 146
VoIP Phone Volume Adjustment	page 217	-	-
Ringtone	page 218	RINGTONE	page 146
Button Feedback	page 218	BUTTON FEEDBACK	page 146
Tone			
Communication Timeout Notification	page 218	-	-
Communication End Pretone	page 219	-	-
Call Queue Notification	page 219	-	-
Paging Pretone	page 220	-	-
Auto Answer Tone	page 220	-	-
On Hold	page 221	-	-
Key Received	page 221	-	-
Communication			
Talk Timeout [sec]	page 222	COMMUNICATION TIMER	page 113
Force Touch-to-Talk	page 222	FORCE TOUCH-TO-TALK	page 113
Monitor			
Monitor Timeout [sec]	page 224	MONITOR TIMER	page 126
Scan Monitor			
Station / Network Camera List	page 224	Scan Monitor Settings	page 126
Dwell Time	page 224	SCAN MONITOR DWELL TIME	page 126
Master Station Display			
Brightness	page 224	SCREEN BRIGHTNESS	page 102
Primary Video Source	page 224	-	-
Aspect Ratio	page 224	-	-
Standby LED State	page 224	STATUS LED IN STANDBY	page 102
Keypad	page 224	-	-
Maintenance			
Initialization	page 225	Initialize User Settings	page 160

*1 This is an administrator privileges setting. If "LOCK TRANSFER SETTINGS" is set to "OFF," this may be configured even with user privileges.

*2 This is an administrator privileges setting. If "Lock" is set to "OFF," this may be configured even with user privileges.

Before Configuring the Station

1. Tap **[Settings]** on the Home screen.

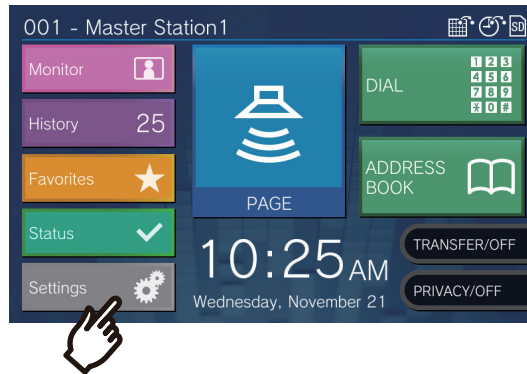

- The privileges selection screen will be shown.

2. Select the privileges to configure.

- To configure using user privileges, tap **[User]** and proceed to Step 4.
- To configure using administrator privileges, tap **[Admin]** and proceed to Step 3.

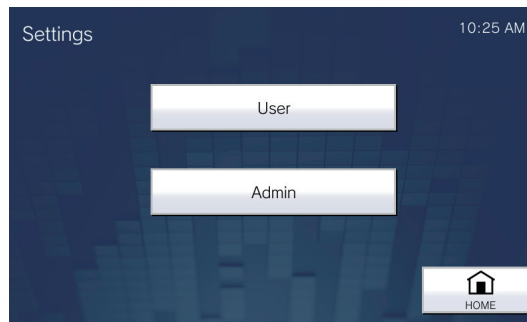

Entry	Description
User	Some settings can be configured.
Administrator	All settings can be configured. The password must be entered.

3. Enter the administrator password, and tap **[ENTER]**.

This password is the same as the administrator password for web configuration. Contact the system administrator for details.

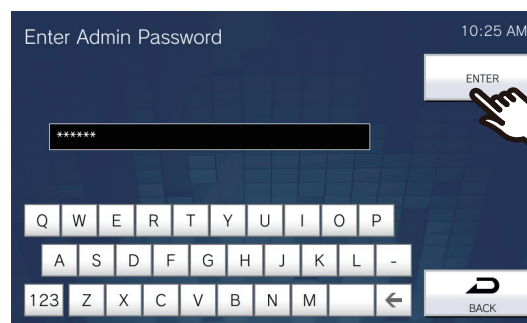

- The Settings (1/2) screen will be shown.

4. Tap the item to configure (refer to the following page for details).

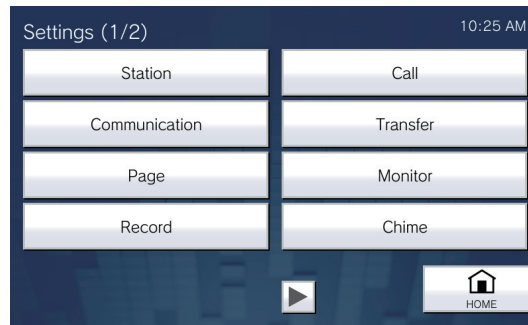

- Tap  to display the Settings 2 screen.

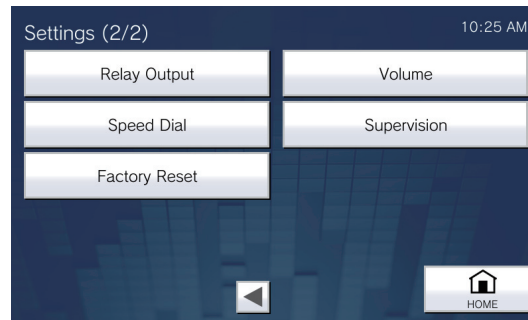

- To exit Settings, use the **[HOME]** button, etc. to return to the Home screen.
- If there is no operation approximately one minute, the station will return to the Home screen and no settings will be saved.

Station Settings

Configure the language, date and time, status LED during standby, and brightness of this station. Display Clean Mode disables the touch panel.

1. Tap **[Station]** on the Settings (1/2) screen.

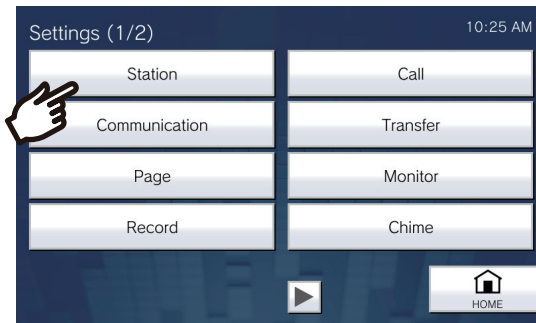

- Station Settings screen will be shown.

2. Change the settings.

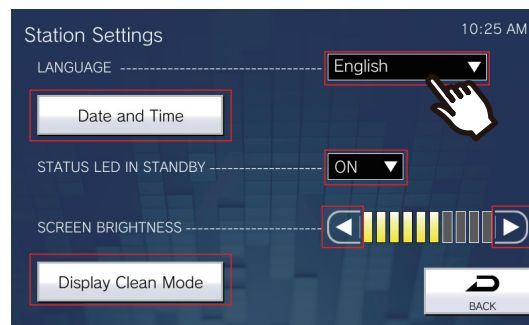

3. Tap [Back].

- The settings will be saved.

Entry	Description	Settings	Default values
Language	Configure the display language. Changing the display language may cause the station name and other text to not display correctly.	<ul style="list-style-type: none"> • 日本語 • English • Français • Español • Nederlands • 繁體中文 • 简体中文 	English
Date and Time	Set the current date and time for this station. This is a required setting. Refer to "How to configure the date and time (→page 103)" for how to configure this.	-	-
STATUS LED IN STANDBY	Select ON / OFF for stand by status LED.	<ul style="list-style-type: none"> • ON (light ON) • OFF (light OFF) 	ON
SCREEN BRIGHTNESS	Set the brightness of the display.	1 - 10	6
Display Clean Mode	Disable the touch screen to clean the screen. The touch screen will be disabled for around 1 minute.	-	-

How to configure the date and time

- (1) Tap **[Date and Time]** on the Settings (1/2) screen.
- (2) Configure the date and time.

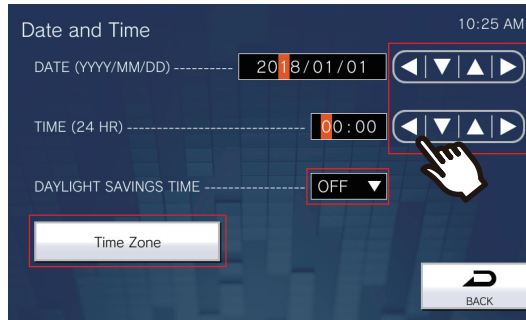

– Tapping **[BACK]** will save the settings. It may take some time to update the settings.

Entry	Description	Settings	Default values
DATE (YYYY/MM/DD)	Set the date for the station.	2017/01/01 - 2037/12/31	The date from 2018/01/01 with the time difference set in "Time Zone" applied
TIME (24 HR)	Set the current time for the station.	00:00	The time from 00:00 with the time difference set in "Time Zone" applied
DAYLIGHT SAVINGS TIME	The daylight saving time is set automatically according by region selected in "Time Zone."	<ul style="list-style-type: none"> • ON • OFF 	OFF
Time Zone	Set the Time Zone. Refer to "How to configure the time zone (→page 103)" for information on how to configure this.	Select from 99 regions	(GMT-08:00) Pacific Standard Time (US), Tijuana

How to configure the time zone

- (1) Tap **[Time Zone]**.
 - The Time Zone screen will be shown.
- (2) Tap the region to configure the time zone.

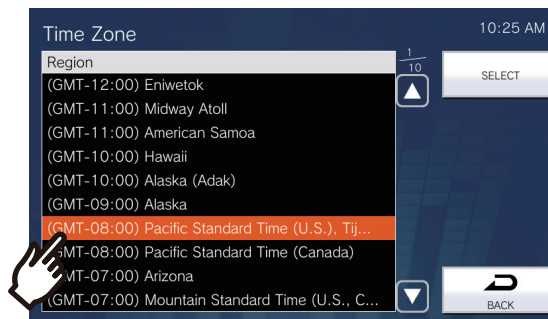

- (3) Tap **[SELECT]**.
 - The settings will be saved.

Call Settings

Configure settings related to outgoing and incoming calls.

1. Tap **[Call]** on the Settings (1/2) screen.

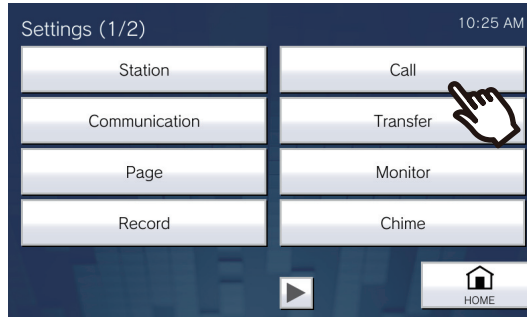

- The Call Settings (1/5) screen will be shown.

2. Configure settings related to "Outgoing Call Setting 1 - Call Timer."



- Tapping **[BACK]** will save the settings.

Entry	Description	Settings	Default values
CALL BUTTON	Set the Call Timeout for outgoing call.	<ul style="list-style-type: none"> • 10 - 600 sec: Select to set between 10 and 600 sec (by 1 sec) • ∞ (infinite): Keep calling until call is answered 	60 sec
OPTION INPUT 1-4	Set the Call Timeout for outgoing call.	<ul style="list-style-type: none"> • 10 - 600 sec: Select to set between 10-600 sec (by 1 sec) • ∞ (infinite): Keep calling until call is answered 	60 sec

Note

- When calling a VoIP Phone, it will be the shorter time of the time set for "Call Timeout" and the call duration configured on the IP-PBX.

3. After the configuration, tap .
- The settings will be saved.

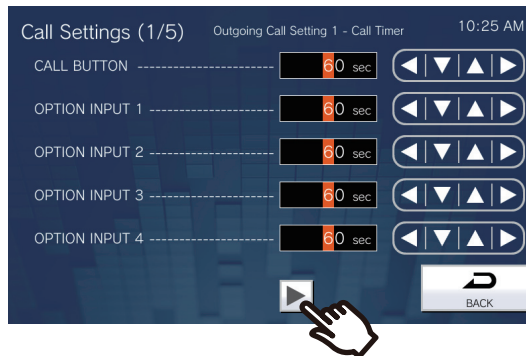

- The Call Settings (2/5) screen will be shown.

4. Configure settings related to "Outgoing Call Setting 2 - Ringback Tone."

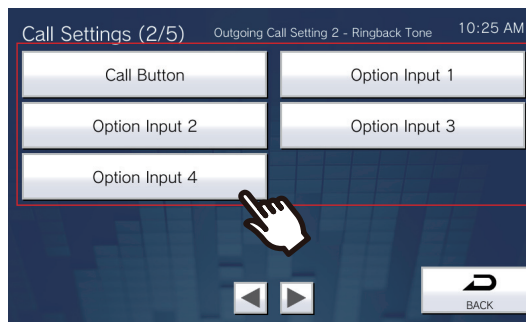

■ Call Button

Configure the ringback tone by a call button.

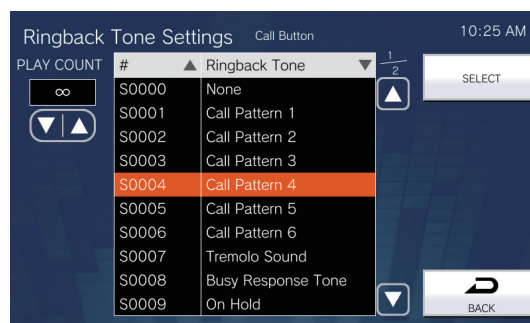

■ Option Input 1 - Option Input 4

Configure the ringback tone by Option Input 1-4.

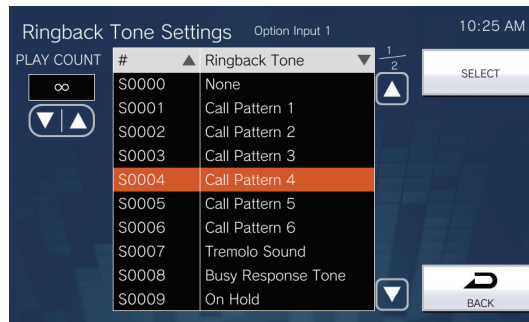

Entry	Description	Settings	Default values
PLAY COUNT	Set the play count of ringback tone for outgoing call. Refer to “How to configure the Ringback Tone (→page 111)” for information on how to set this.	<ul style="list-style-type: none"> • 1-20 times • ∞ (infinite): The ringback tone continues to play for the amount of time set in "Main unit operation call timer" and "Contact 1-4 call timer." 	∞ (infinite)
Ringback Tone	Select the sound to be played by the station when placing a call. Refer to “How to configure the Ringback Tone (→page 111)” for information on how to set this.	<ul style="list-style-type: none"> • None • Call Pattern 1 • Call Pattern 2 • Call Pattern 3 • Call Pattern 4 • Call Pattern 5 • Call Pattern 6 • Tremolo Sound • Busy Response Tone • On Hold • Operation Sound • Error • Pre Tone 1 • Pre Tone 2 • Pre Tone 3 • Communication End Pretone • Call Queue Notification • Waiting Reply Tone • Select a sound that is registered in “Custom Sound Registry (→page 172)”. 	Call Pattern 4

5. After the configuration, tap .

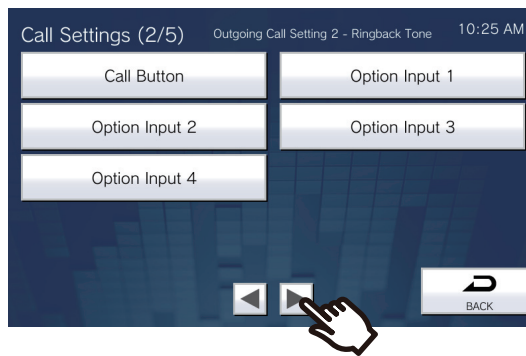

- The Call Settings (3/5) screen will be shown.

6. Configure settings related to "Incoming Call Setting 1 - Ringtone Count."

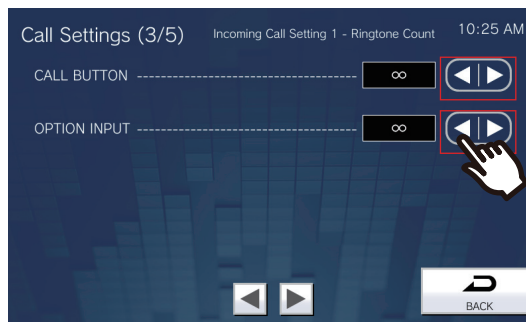

- Tapping **[Back]** will save the settings.

Entry	Description	Settings	Default values
CALL BUTTON	Set the play count of ringtone for incoming call.	<ul style="list-style-type: none"> • ∞ (infinite): Keep ringing until the call is answered or canceled. • 1-20 times 	∞ (infinite)
OPTION INPUT	Set the play count of ringtone for incoming call.	<ul style="list-style-type: none"> • ∞ (infinite): Keep ringing until the call is answered or canceled. • 1-20 times 	∞ (infinite)

7. After the configuration, tap .
- The settings will be saved.

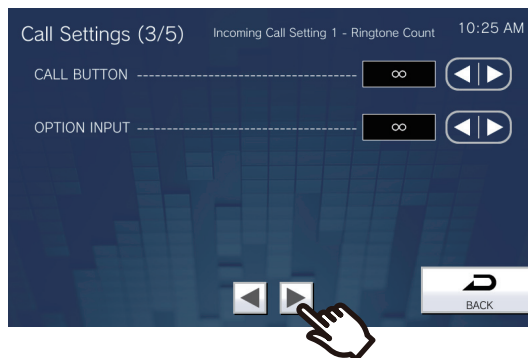

- The Call Settings (4/5) screen will be shown.

8. Configure settings related to "Incoming Call Setting 2 - Ringtone."

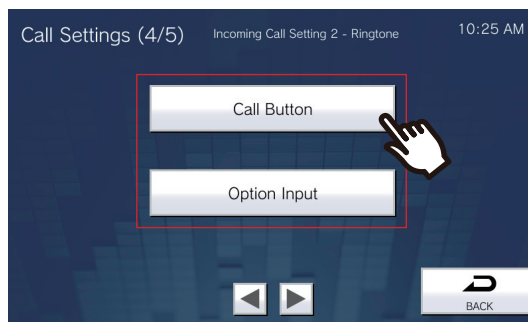

■ Call Button

Configure the ringtone for each priority when a call is received by the call button. This can be configured for each source station. Refer to [“How to configure the Ringtone \(→page 112\)”](#) for how to configure this.

■ Option Input

Configure the ringtone for each priority when a Option Input call is received. This can be configured for each source station. Refer to [“How to configure the Ringtone \(→page 112\)”](#) for information on how to configure this.

Entry	Description	Settings	Default values
Ringtone	Select the ringtone for incoming call. Ringtone can be set per each source station.	<ul style="list-style-type: none"> • None • Call Pattern 1 • Call Pattern 2 • Call Pattern 3 • Call Pattern 4 • Call Pattern 5 • Call Pattern 6 • Tremolo Sound • Busy Response Tone • On Hold • Operation Sound • Error • Pre Tone 1 • Pre Tone 2 • Pre Tone 3 • Communication End Pretone • Call Queue Notification • Waiting Reply Tone • Select a sound that is registered in “Custom Sound Registry (→page 172)”. 	Call Button: Call Pattern 1 Option Input: Call Pattern 2

9. After the configuration, tap .

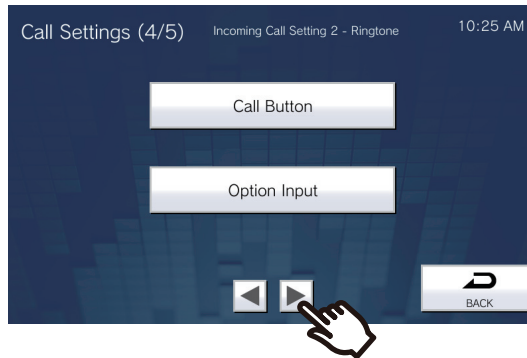

- The Call Settings (5/5) screen will be shown.

10. Configure settings related to "Incoming Call Setting 3."

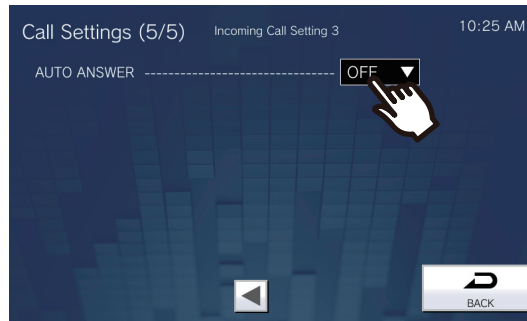

11. Tap **[Back]**.

- The settings will be saved.

Entry	Description	Settings	Default values
AUTO ANSWER	Select ON / OFF to automatically answer the individual call. Auto Answer: When receiving an individual call, answer automatically. When receiving a call from VoIP Phone and transferring a call, it must be answered manually.	<ul style="list-style-type: none"> • ON (Auto Answer) • OFF (No Auto Answer) 	OFF

How to configure the Ringback Tone

- (1) Tap **[Call Button]** or **[Option Input 1] - [Option Input 4]**.
- (2) Configure the ringback tone play count and tone.
 - The selected ringback tone will continue to play.

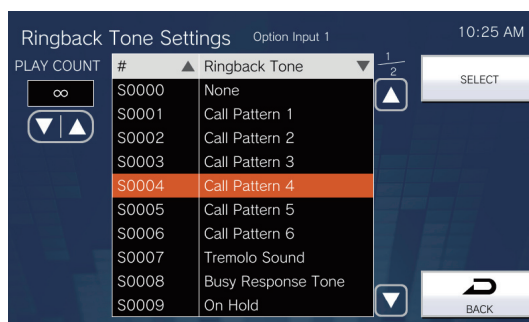

- (3) Tap **[SELECT]**.
 - The settings will be saved.

How to configure the Ringtone

- (1) Tap **[Call Button]** or **[Option Input]** on the Calling Settings (4/5) screen.
 - The Ringtone Settings screen will be shown.
- (2) Tap the source station to change the ringtone.
 - Refer to [“Searching for stations \(→page 32\)”](#) to search stations.
 - Tap **[DIAL]** to search by Station Number. Refer to [“Selecting / Choosing / Calling by Number \(→page 30\)”](#) for how to search using this.

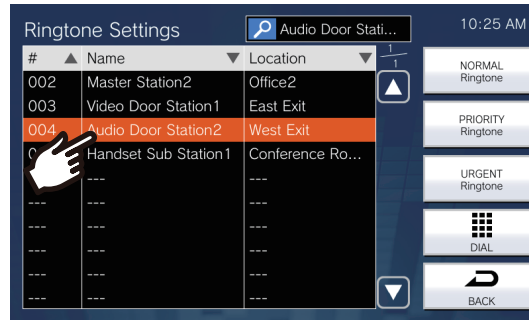

- (3) Tap **[NORMAL Ringtone]**, **[PRIORITY Ringtone]**, or **[URGENT Ringtone]** to select the priority.
 - The selected ringtone will continue to play.

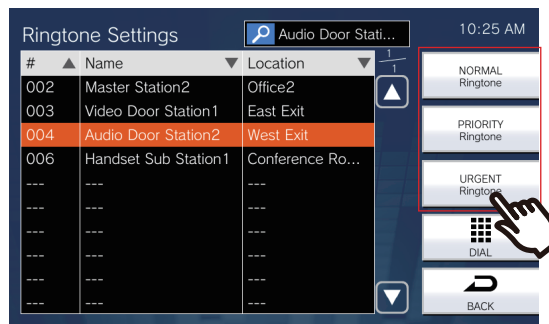

- (4) Tap the ringtone to set.

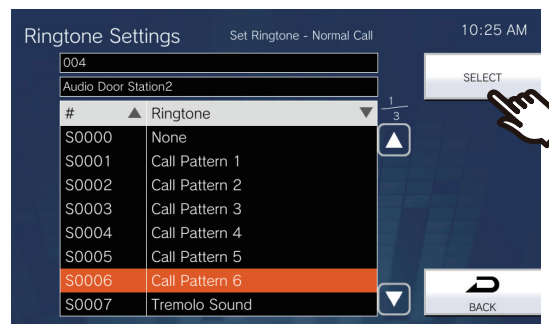

- (5) Tap **[SELECT]**.
 - The settings will be saved.

Communication Settings

Configure the call duration and whether to always use touch-to-talk.

1. Tap **[Communication]** on the Settings (1/2) screen.

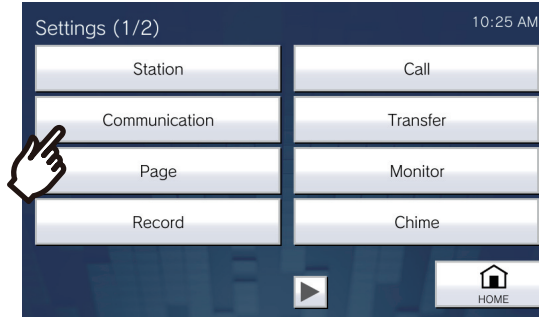

- The Communication Settings screen will be shown.

2. Configure the settings.

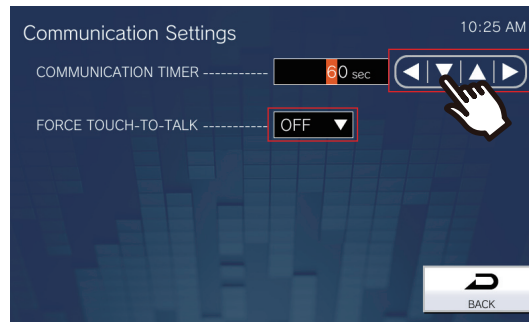

3. Tap **[Back]**.
 - The settings will be saved.

Entry	Description	Settings	Default values
COMMUNICATION TIMER	Set the communication timer when placing a call. Communication timer when receiving a call is set at the destination station.	<ul style="list-style-type: none"> • 30 - 600 seconds: Configure between 30 to 600 sec (by 1 sec). • ∞ (infinite): The call will continue until the call is ended. 	60 sec.
FORCE TOUCH-TO-TALK	Select Enable / Disable for Force Touch-to-Talk when starting communication in hands-free mode.	<ul style="list-style-type: none"> • ON • OFF 	OFF

! Important

- While in communication with the VoIP Phone, whichever "COMMUNICATION TIMER" is shorter will take priority.

Transfer Settings

Configure settings related to absent transfer, delay transfer, and schedule transfer.

*This is an administrator privileges setting. If "LOCK TRANSFER SETTINGS" is set to "ON," this cannot be configured under user privileges.

- Absent Transfer:
An incoming call can be automatically transferred to the transfer destination if it is received while absent transfer is set.
- Delay Transfer:
An incoming call can be automatically transferred to the transfer destination if it is received when delay transfer is set and not answered over a certain period of time (Delay Time).
- Schedule Transfer:
An incoming call can be automatically transferred to the transfer destination, if an incoming call is received during the time configured in the weekly schedule or daily schedule.

! Important

- When an incoming call is received from a VoIP phone, the call will be received without transferring even when transfer is set. To transfer the call, configure transferring on the IP-PBX.

1. Tap **[Transfer]** on the Settings (1/2) screen.

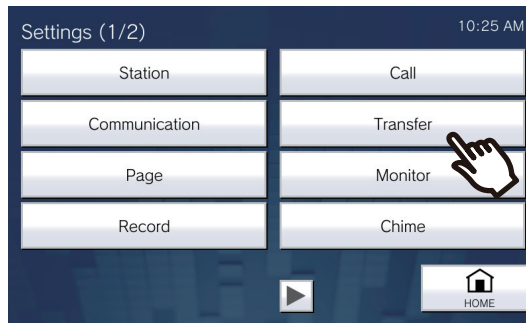

- The Transfer Settings screen will be shown.

2. Configure the settings.

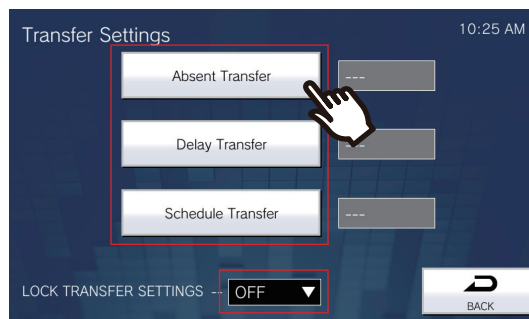

Entry	Description	Settings	Default values
Absent Transfer	Select Enable / Disable for Absent Transfer. If "How to configure Absent Transfer (→page 116)" is not configured, this cannot be set to "ON." The setting can also be changed with the TRANSFER button on the station.	<ul style="list-style-type: none"> • ON (absent transfer enabled) • OFF (absent transfer disabled) 	OFF
Delay Transfer	Select Enable / Disable for Delay Transfer. If "How to configure Delay Transfer (→page 117)" is not configured, this cannot be set to "ON."	<ul style="list-style-type: none"> • ON (delay transfer enabled) • OFF (delay transfer disabled) 	OFF
Schedule Transfer	Select Enable / Disable for Schedule Transfer. If "How to configure Schedule Transfer (Daily Schedule) (→page 119)" or "How to configure Schedule Transfer (Weekly Schedule) (→page 122)" is not configured, this cannot be set to "ON."	<ul style="list-style-type: none"> • ON (schedule transfer enabled) • OFF (schedule transfer disabled) 	OFF
LOCK TRANSFER SETTINGS (administrator account only)	Select ON / OFF to Lock Transfer function. When set to "ON", transfer function cannot be changed by user account.	<ul style="list-style-type: none"> • ON (Cannot be configured with user account) • OFF (Can be configured with user account) 	OFF

How to configure Absent Transfer

! Important

- Do not configure multiple VoIP phones as transfer destinations. If multiple VoIP phones are configured, calls will be transferred to only one VoIP phone.

- (1) Tap **[Absent Transfer]** on the Transfer Settings screen.
 - The Absent Transfer Settings screen will be shown.
- (2) Tap **[NEW]** to configure the transfer destination station.
 - To configure a retransfer destination, tap the "Re" row and tap **[EDIT]**.
 - *Up to 10 transfer destinations and 1 retransfer (i.e. transfer a transferred call) destination can be configured.
 - *Configure transfer destinations in the 1-10 fields in the "#". column on the left of the transfer destination station list, and the retransfer destination in "Re".
 - To change a registered transfer destination station, tap the station to change, and tap **[EDIT]**.
 - To delete a registered transfer destination station, tap the station to delete, and then tap **[DELETE]**.

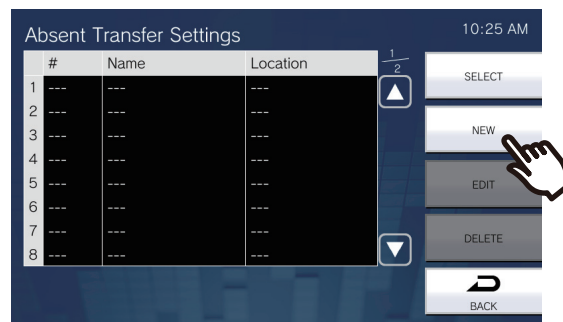

- The Select Destination screen will be shown.
- (3) Tap the station to configure as a transfer destination.
 - *Refer to "[Searching for stations \(→page 32\)](#)" to search stations.

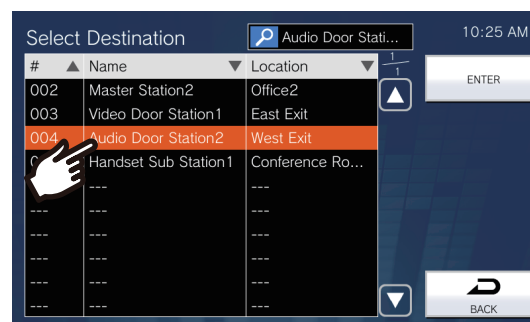

- (4) Tap **[ENTER]**.
 - The Absent Transfer Settings screen will be shown.
- (5) Tap **[SELECT]**.
 - The settings will be saved.

How to configure Delay Transfer

! Important

- Do not configure multiple VoIP phones as transfer destinations. If multiple VoIP phones are configured, calls will be transferred to only one VoIP phone.

- (1) Tap **[Delay Transfer]** on the Transfer Settings screen.
 - The Delay Transfer Settings screen will be shown.
- (2) Tap **[NEW]** to configure the transfer destination station.
 - To configure a retransfer destination, tap the "Re" row and tap **[EDIT]**.
 - *Up to 10 transfer destinations and a single retransfer (i.e. transfer a transferred call) destination can be configured.
 - *Configure transfer destinations in the 1-10 fields in the "#". column on the left of the transfer destination station list, and the retransfer destination in "Re".
 - To change a registered transfer destination station, tap the station to change, and then tap **[EDIT]**.
 - To delete a registered transfer destination station, tap the station to delete, and then tap **[DELETE]**.



- The Select Destination screen will be shown.

- (3) Tap the station to configure as a transfer destination.
 - *Refer to [“Searching for stations \(→page 32\)”](#) to search stations.

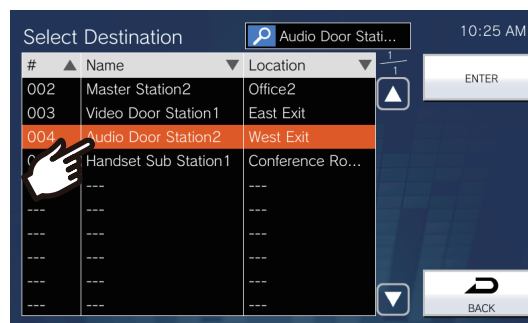

- (4) Tap **[ENTER]**.
 - The Delay Transfer Settings screen will be shown.

(5) Configure **[DELAY TIMER]**.

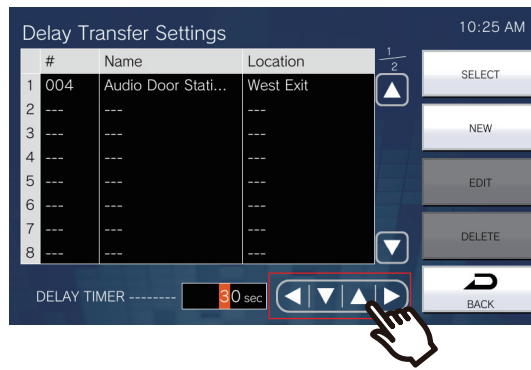

(6) Tap **[SELECT]**.

– The settings will be saved.

Entry	Description	Settings	Default values
DELAY TIMER	Set the delay time between receiving and transferring a call.	1-300 sec (by 1 sec)	30 sec.

How to configure Schedule Transfer (Daily Schedule)

Configure the transfer destination and time for schedule transfer, in units of one day. One year from the set day can be configured. 12 schedules can be set for each day.

! Important

- Do not configure multiple VoIP phones as transfer destinations. If multiple VoIP phones are configured, calls will be transferred to only one VoIP phone.

- (1) Tap **[Schedule Transfer]** on the Transfer Settings screen.
 - The Transfer Schedule screen will be shown. It may take some time for the schedule to be displayed.
- (2) Tap the day to set a schedule.

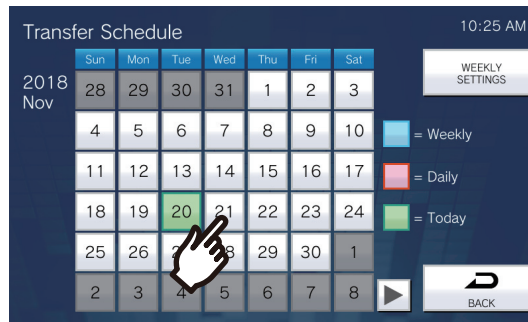

– The Daily Schedule screen will be shown for the day that was tapped.

- (3) Tap **[NEW]**.
 - *To change a registered schedule, tap the row to change, and tap **[EDIT]**.
 - *To delete a registered schedule, tap the row to delete, and tap **[DELETE]**.
 - *To delete all individual schedules of the displayed day, tap **[DELETE ALL]**.
 - *Refer to [“How to configure Schedule Transfer \(Weekly Schedule\) \(→page 122\)”](#) for changing and deleting schedules registered as Weekly Schedule.

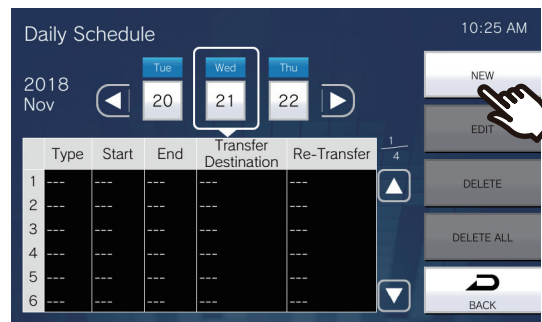

– The Set Daily Schedule screen will be shown.

- (4) Tap **[NEW]** to configure the transfer destination station.
 - To configure a retransfer destination, tap the "Re" row and tap **[EDIT]**.
 - *Up to 10 transfer destinations and a single retransfer (i.e. transfer a transferred call) destination can be configured.
 - *Configure the first transfer destinations in the 1-10 fields in the "#" column on the left of the transfer destination station list, and the retransfer destination in "Re".
 - To change a registered transfer destination station, tap the station to change, and tap **[EDIT]**.
 - To delete a registered transfer destination station, tap the station to delete, and then tap **[DELETE]**.

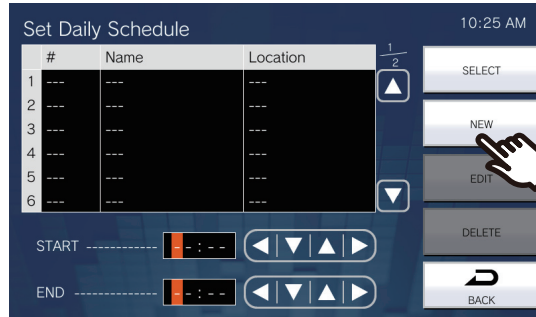

- The Select Destination screen will be shown.

- (5) Tap the station to configure as a transfer destination.
 - *Refer to ["Searching for stations \(→page 32\)"](#) to search stations.

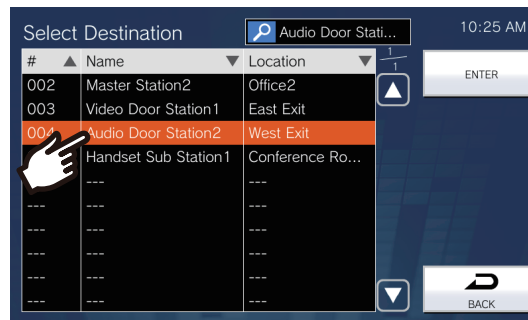

- (6) Tap **[ENTER]**.
 - The Set Daily Schedule screen will be shown.
- (7) Configure the start time and end time.

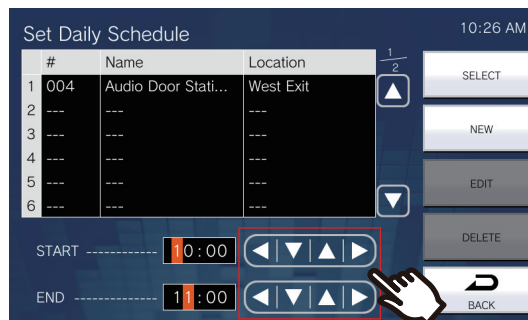

- (8) Tap **[SELECT]**.
– The settings will be saved.

Entry	Description	Settings	Default values
START	Set the Start Time to enable schedule transfer.	00:00 - 23:59	-
END	Set the End Time to disable schedule transfer. If this is set earlier than "Start Time," End will be for the following day.	00:00 - 23:59	-

How to configure Schedule Transfer (Weekly Schedule)

Configure the transfer destination and time for schedule transfer, for each day of the week from Sunday through Saturday. Up to 12 schedules can be set for each day of the week.

! Important

- Do not configure multiple VoIP phones as transfer destinations. If multiple VoIP phones are configured, calls will be transferred to only one VoIP phone.

- (1) Tap **[Schedule Transfer]** on the Transfer Settings screen.
 - The Transfer Schedule screen will be shown. It may take some time for the schedule to be displayed.
- (2) Tap **[WEEKLY SETTINGS]**.

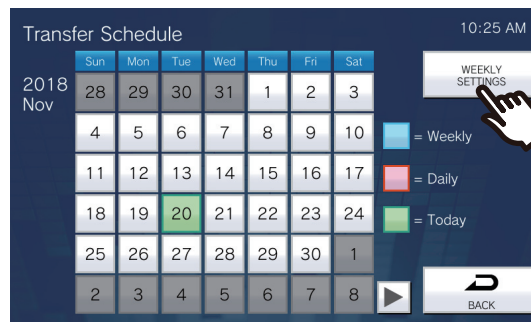

– The Weekly Schedules screen will be shown.

- (3) Tap the day of the week to configure transferring.

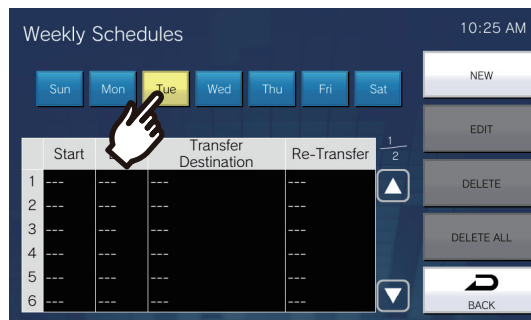

- (4) Tap **[NEW]**.
 - *To change a registered schedule, tap the row to change, and tap **[EDIT]**.
 - *To delete a registered schedule, tap the row to delete, and tap **[DELETE]**.
 - *To delete all weekly schedules of the displayed day of the week, tap **[DELETE ALL]**.

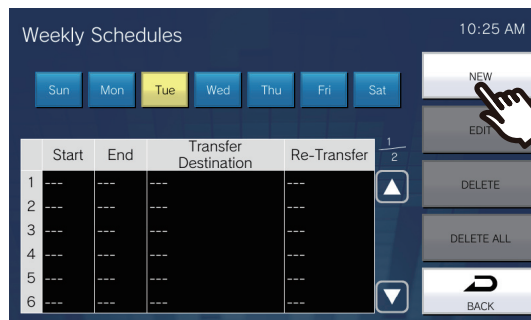

– The Set Weekly Schedule screen will be shown.

- (5) Tap **[NEW]** to configure the transfer destination station.

To configure a retransfer destination, tap the "Re" row and tap **[EDIT]**.

*Up to 10 transfer destinations and a single retransfer (i.e. transfer a transferred call) destination can be configured.

*Configure transfer destinations in the 1-10 fields in the "#" column on the left of the transfer destination station list, and the retransfer destination in "Re".

- To change a registered transfer destination station, tap the station to change, and tap **[EDIT]**.
- To delete a registered transfer destination station, tap the station to delete, and tap **[DELETE]**.

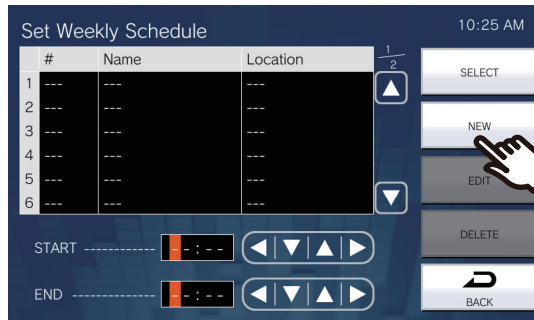

- The Select Destination screen will be shown.

- (6) Tap the station to configure as a transfer destination.

*Refer to ["Searching for stations \(→page 32\)"](#) to search stations.

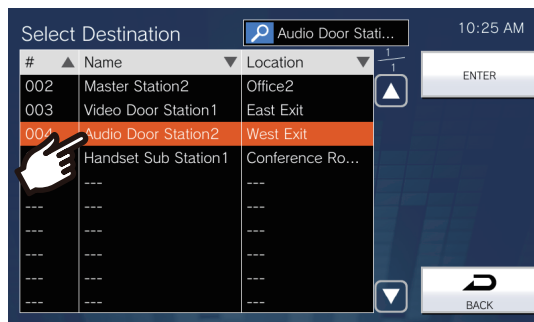

- (7) Tap **[ENTER]**.

- The Set Weekly Schedule screen will be shown.

- (8) Configure the start time and end time.

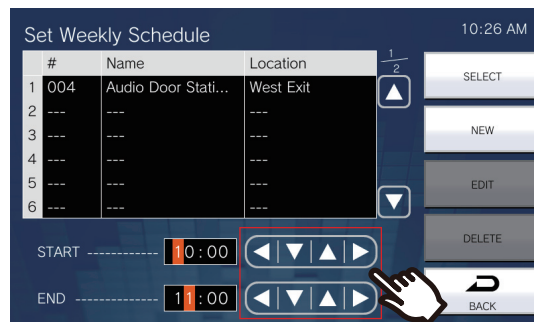

- (9) Tap **[SELECT]**.
 - The settings will be saved.

Entry	Description	Settings	Default values
START	Set the Start Time to enable schedule transfer.	00:00 - 23:59	-
END	Set the End Time to disable schedule transfer. If this is set earlier than "Start Time," END will be for the following day.	00:00 - 23:59	-

Paging Settings

Configure settings related to paging.

1. Tap **[Page]** on the Settings (1/2) screen.

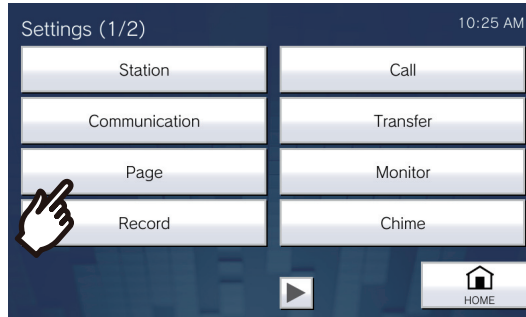

- The Paging Settings screen will be shown.

2. Configure the settings.

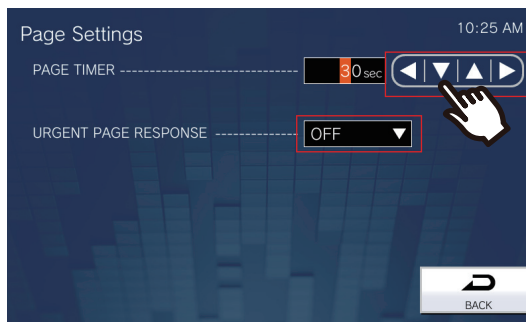

3. Tap **[BACK]**.
 - The settings will be saved.

Entry	Description	Settings	Default values
PAGE TIMER	Set the time for outgoing paging duration.	10 - 600 sec (by 1 sec)	30 sec
URGENT PAGE RESPONSE (administrator privileges only)	Configure whether to refuse communication or ending operations on the destination station, when an urgent page is sent. Urgent message pages and urgent external input pages cannot be refused.	<ul style="list-style-type: none"> • ON (refuse) • OFF (do not refuse) 	OFF

! Important

- If the source station is IX-MV, end operations can be performed even if Urgent Page Response is set to "ON."

Monitor Settings

Configure settings related to monitoring and scan monitoring.

Scan monitoring: This function automatically switches monitoring between multiple stations and network cameras (other than VoIP phones) for a certain interval.

1. Tap **[Monitor]** on the Settings (1/2) screen.

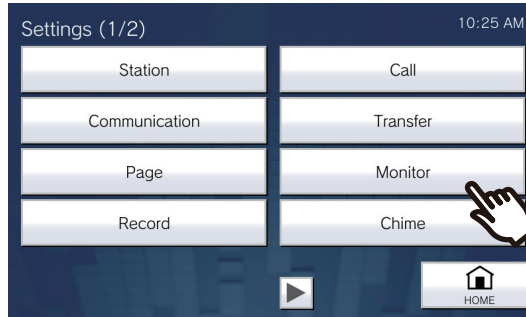

- The Monitor Settings screen will be shown.

2. Configure the settings.

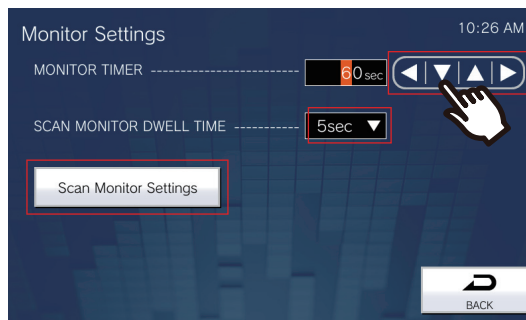

3. Tap **[Back]**.
 - The settings will be saved.

Entry	Description	Settings	Default values
MONITOR TIMER	Set the monitoring timer by station. Scan Monitor must be end manually.	<ul style="list-style-type: none"> • 10 - 600 sec: Configure between 10 and 600 sec (by 1 sec). • ∞ (infinite): No timeout. 	60 sec
SCAN MONITOR DWELL TIME	Set the dwell time to change destination for scan monitor.	<ul style="list-style-type: none"> • 5 sec • 10 sec • 30 sec 	5 sec
Scan Monitor Settings	Configure the stations and network cameras to perform scan monitoring. Refer to " How to configure Scan Monitoring (→page 127) " for information on how to configure this.	-	-

How to configure Scan Monitoring

- (1) Tap **[Scan Monitor Settings]** on the Monitor Settings screen.
 - The Scan Monitor Settings screen will be shown.
- (2) Tap **[NEW]** and configure the stations and network cameras to perform scan monitoring.
 - To change a registered station or network camera, tap the station or network camera to change, and tap **[EDIT]**.
 - To delete a registered station or network camera, tap the station or network camera to delete, and tap **[DELETE]**.

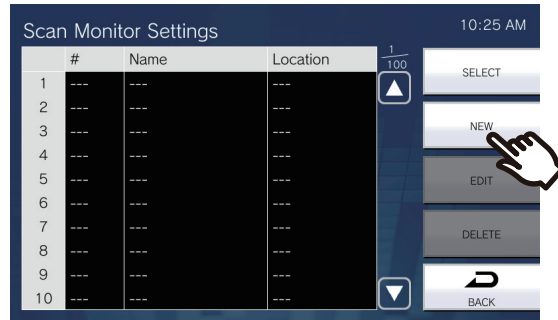

- The Scan Monitor Stations screen will be displayed.
- (3) Tap the stations and network cameras to perform scan monitoring.
 - Refer to [“Searching for stations \(→page 32\)”](#) to search stations.

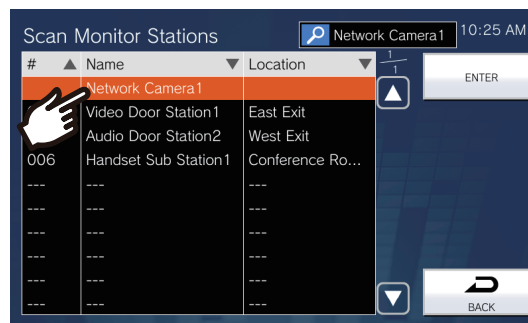

- (4) Tap **[ENTER]**.
 - The Scan Monitor Settings screen will be shown.
- (5) Tap **[SELECT]**.

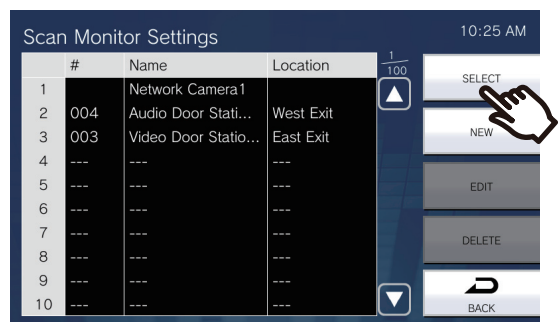

- The settings will be saved.

Record Settings

Configure settings related to video/audio recording. If there is no image, only audio will be recorded. When recording audio during a call, audio of this station will also be recorded.

! Important

- Video/audio cannot be recorded even if configured if no microSD card is inserted. Refer to [“About microSD card \(→page 27\)”](#) for details.

1. Tap **[Record]** on the Settings (1/2) screen.

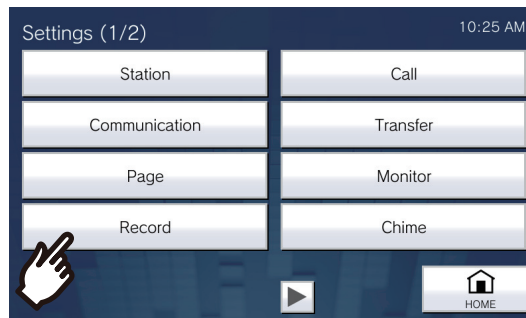

- The Record Settings screen will be shown.

2. Configure the settings.

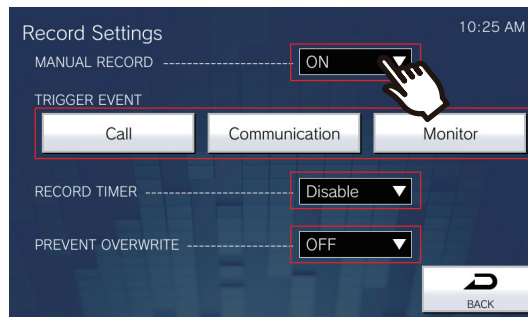

3. Tap **[Back]**.
- The settings will be saved.

Entry	Description	Settings	Default values
MANUAL RECORD	Select ON / OFF for manual recording.	<ul style="list-style-type: none"> ON OFF 	ON
TRIGGER EVENT	Configure the trigger in use to start recording video/audio automatically.	Select from the following. (Multiple selections allowed) <ul style="list-style-type: none"> Call: Record start when station receives Incoming Call. If a call is automatically answered, recording will start when communication starts. Communication: Recording starts when communication begins. Monitor: Recording starts when monitoring begins. Recording is not possible during Scan Monitor. 	Not selected
RECORD TIMER	Set the recording duration when the event trigger has occurred.	<ul style="list-style-type: none"> Disable: Does not stop until the operating status ends or the record button is tapped. 5 sec 10 sec 30 sec 	Disable
PREVENT OVERWRITE	Set prevent overwriting the old recorded file, when the number of saved video/audio files or microSD card capacity space is full.	<ul style="list-style-type: none"> ON (do not overwrite) OFF (overwrite) 	OFF

 **Note**

- If "Record Event" is set to "Incoming Call" and multiple calls are received, video/audio is recorded from the first call. Other calls will begin video/audio recording when the first calls ends or when the call is answered.

Chime Settings

Configure settings related to chimes ([“Configuring the station sound a tone on a schedule \(→page 88\)”](#)).

1. Tap **[Chime]** on the Settings (1/2) screen.

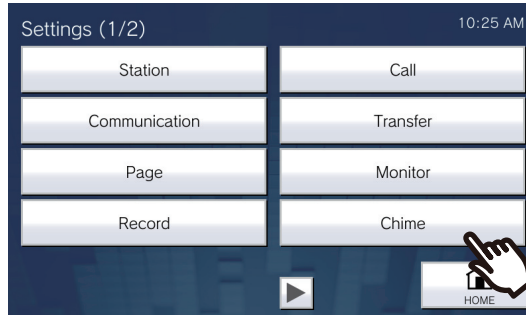

- The Chime Schedule screen will be shown. It may take some time.

2. Configure detailed settings.

- Refer to [“How to configure Chime Settings \(Daily Schedule\) \(→page 131\)”](#) to configure for each day.
- Refer to [“How to configure Chime Settings \(Weekly Schedule\) \(→page 133\)”](#) to configure for each day of the week.

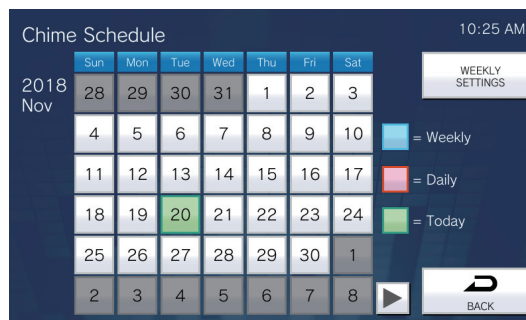

How to configure Chime Settings (Daily Schedule)

Configure the chime tone start time and the chime tone, for each day. One year from the set day can be configured. 50 schedules can be set for each day.

- (1) On the Chime Schedule screen, tap the day to configure a schedule.

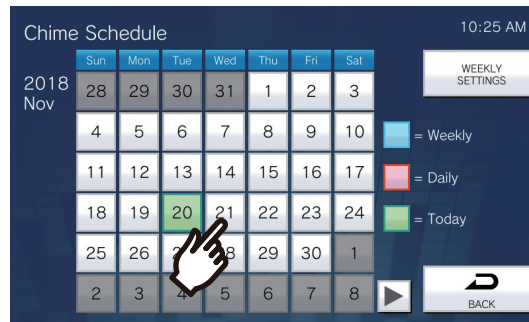

– The Daily Schedule screen will be shown.

- (2) Tap **[NEW]**.

*To change a registered schedule, tap the row to change, and tap **[EDIT]**.

*To delete a registered schedule, tap the row to delete, and tap **[DELETE]**.

*To delete all daily schedules for the displayed day, tap **[DELETE ALL]**.

*Refer to [“How to configure Chime Settings \(Weekly Schedule\) \(→page 133\)”](#) for changing and deleting schedules registered as Weekly Schedule.

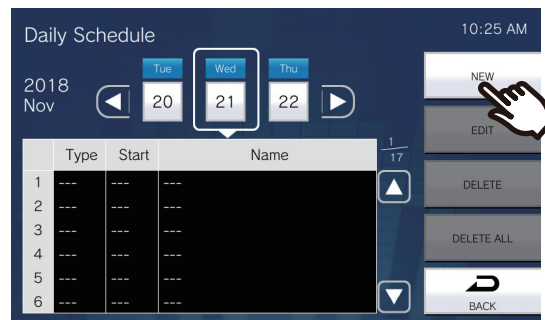

– The Set Daily Schedule screen will be shown.

- (3) Tap **[EDIT]**.

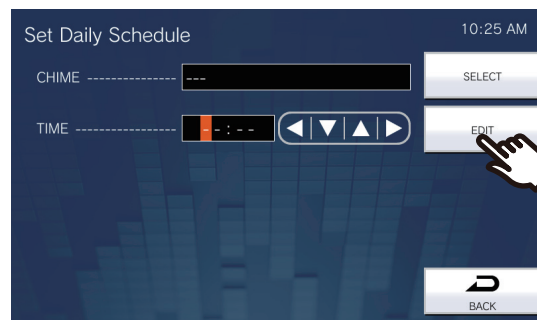

– The Select Chime screen will be shown.

- (4) Tap the chime tone to play.
 - Refer to [“Searching for stations \(→page 32\)”](#) to search chime tones.

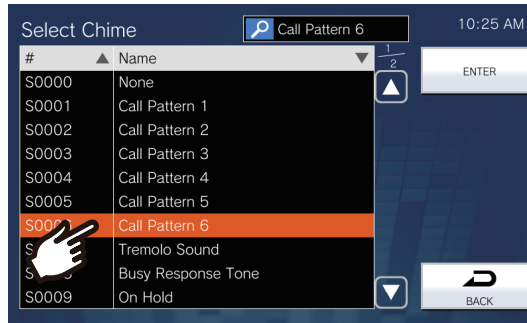

- (5) Tap **[ENTER]**.
 - The Set Daily Schedule screen will be shown.
- (6) Configure the start time.

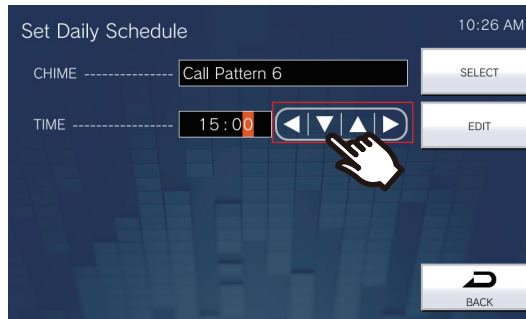

- (7) Tap **[SELECT]**.
 - The settings will be saved.

Entry	Description	Settings	Default values
CHIME	Set the sound for chime.	<ul style="list-style-type: none"> • None • Call Pattern 1 • Call Pattern 2 • Call Pattern 3 • Call Pattern 4 • Call Pattern 5 • Call Pattern 6 • Tremolo Sound • Busy Response Tone • On Hold • Operation Sound • Error • Pre Tone 1 • Pre Tone 2 • Pre Tone 3 • Communication End Pretone • Call Queue Notification • Waiting Reply Tone • Select a sound that is registered in “Custom Sound Registry (→page 172)”. 	None
TIME	Configure the time to begin playing the chime tone.	00:00 - 23:59	-

How to configure Chime Settings (Weekly Schedule)

Configure the chime tone start time and the chime tone for each day of the week from Sunday through Saturday. 50 schedules can be configured for each day of the week.

- (1) On the Chime Schedule screen, tap **[WEEKLY SETTINGS]**.

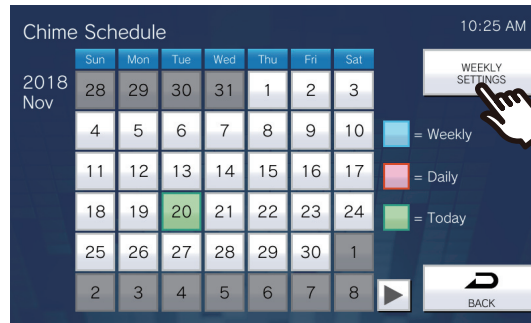

– The Weekly Schedules screen will be shown.

- (2) Tap the day of the week to configure the chime.

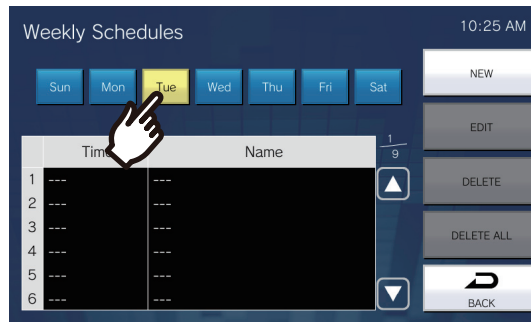

- (3) Tap **[NEW]**.

*To change a registered schedule, tap the row to change, and tap **[EDIT]**.

*To delete a registered schedule, tap the row to delete, and tap **[DELETE]**.

*To delete all weekly schedules of the displayed day of the week, tap **[DELETE ALL]**.

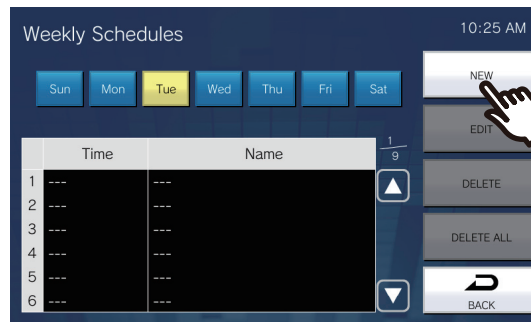

– The Set Weekly Schedule screen will be shown.

(4) Tap [EDIT].

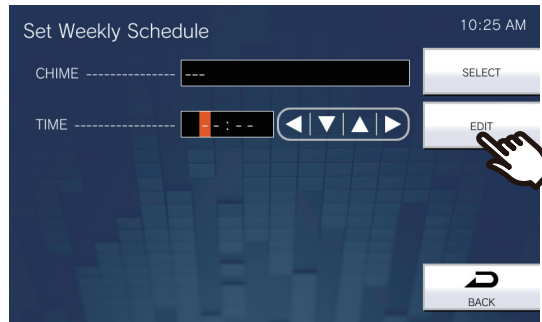

– The Select Chime screen will be shown.

(5) Tap the chime tone to play.

*Refer to [“Searching for stations \(→page 32\)”](#) to search chime tones.

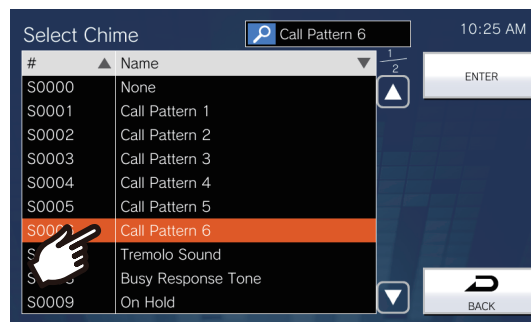

(6) Tap [ENTER].

– The Set Weekly Schedule screen will be shown.

(7) Configure the start time.

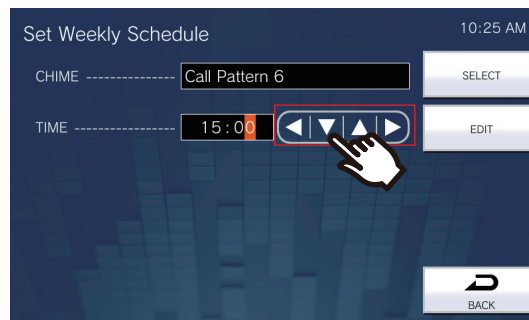

- (8) Tap **[SELECT]**.
 – The settings will be saved.

Entry	Description	Settings	Default values
CHIME	Set the sound for chime.	<ul style="list-style-type: none"> • None • Call Pattern 1 • Call Pattern 2 • Call Pattern 3 • Call Pattern 4 • Call Pattern 5 • Call Pattern 6 • Tremolo Sound • Busy Response Tone • On Hold • Operation Sound • Error • Pre Tone 1 • Pre Tone 2 • Pre Tone 3 • Communication End Pretone • Call Queue Notification • Waiting Reply Tone • Select a sound that is registered in "Custom Sound Registry" (→page 172). 	None
TIME	Set the Time to ring Chime.	00:00 - 23:59	-

Relay Output Settings (administrator privileges only)

Configure settings related to relay output.

! Important

- The four relay output methods are shown below. Redundant configuration is possible for each output terminal. If multiple commands occur during a single relay output, the latest command will take priority.
 - Function selected in [“FUNCTION \(→page 137\)”](#)
 - Function selected in [“OPTION RELAY CONTROL \(→page 137\)”](#)
 - Function selected in [“Relay Output 1 Schedule Settings, Relay Output 2 Schedule Settings \(→page 138\)”](#)
 - CGI control

1. On the Settings(2/2) screen, tap **[Relay Output]**.

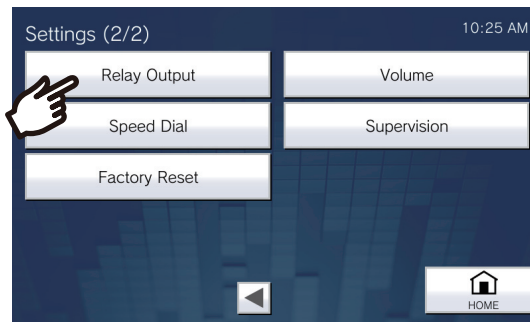

- The Relay Output Settings screen will be shown.

2. Configure the settings.

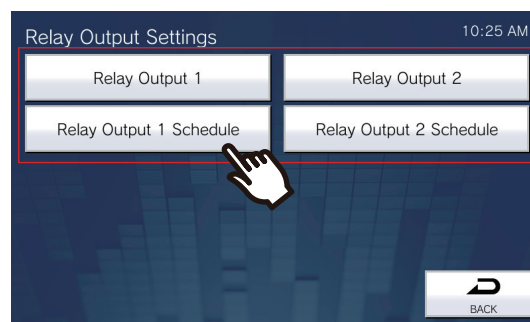

■ Relay Output 1 - Relay Output 2

On the Relay Output Settings screen, tap **[Relay Output 1]** or **[Relay Output 2]**.

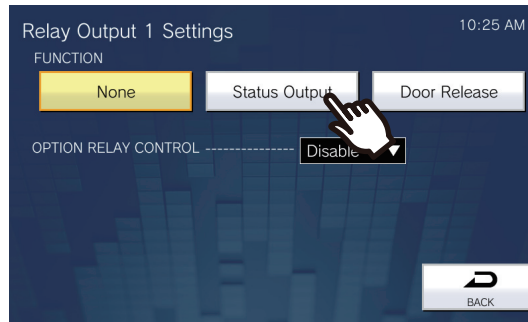

- The Relay Output Settings (Advanced) screen will be shown.

Entry	Description	Settings	Default values
FUNCTION	Select the function of the Relay Output.	<ul style="list-style-type: none"> • None • Status Output: Relay Output during the status. The details setting can be set in "How to configure the Status Output (→page 139)" . • Door Release: Relay output when door release is activated or, entering the authentication key using keypad of the station or the VoIP Phone. Refer to "How to configure the Door Release (→page 140)" for information on how to configure this. If a door release operation is performed on another station, the electrical lock will not be released unless "Code" is configured. Be sure to configure "Code" via Web configuration or the IX Support Tool. 	None
OPTION RELAY CONTROL	Select Enable / Disable for Option Relay Control when using the speed dial of IX-MV7-* to control the output. This can be controlled as optional relay if set to "Enable." If "Option Relay Control Authentication Key" is not configured, this will not operate even if set to "Enable." Be sure to also configure "Option Relay Control Authentication Key" via web configuration.	<ul style="list-style-type: none"> • Enable • Disable 	Disable

■ Relay Output 1 Schedule Settings, Relay Output 2 Schedule Settings

Configure the schedule to perform relay output for relay output 1 and relay output 2. Refer to [“How to configure Relay Output Schedule \(Daily Schedule\) \(→page 141\)”](#) and [“How to configure Relay Output Schedule \(Weekly Schedule\) \(→page 143\)”](#) for how to configure this.

How to configure the Status Output

- (1) On the Relay Output Settings (Advanced) screen, tap **[Status Output]**.

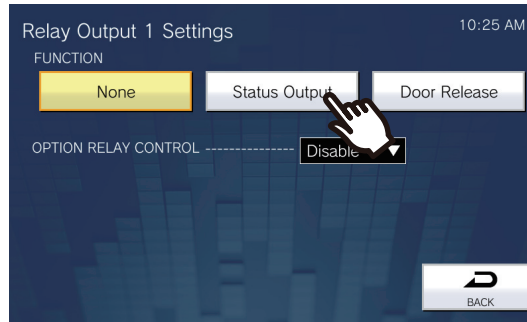

– The Status Output screen will be shown.

- (2) Select the operation to perform relay output (multiple selections allowed).

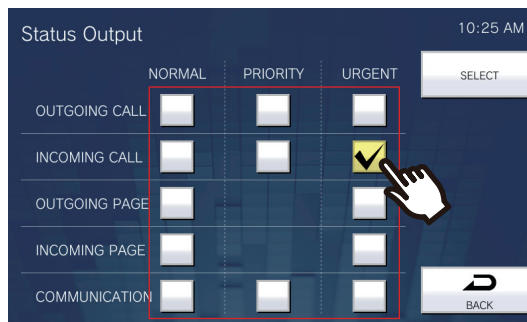

- (3) Tap **[SELECT]**.

– The settings will be saved.

How to configure the Door Release

- (1) On the Relay Output Settings (Advanced) screen, tap **[Door Release]**.

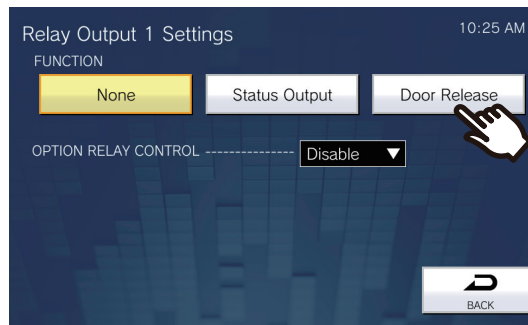

– The Set Relay Output - Door Release screen will be shown.

- (2) Configure detailed settings.

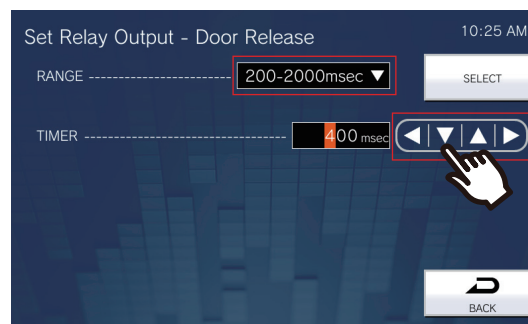

- (3) Tap **[SELECT]**.

– The settings will be saved.

Entry	Description	Settings	Default values
TIMER (Relay Control Settings)	Select the Output Time Range for relay output if " FUNCTION (→page 137) " is set to "Door Release" or if the output terminal is controlled via CGI.	<ul style="list-style-type: none"> • 200 to 2000 msec: Select this to set a time between 200 and 2000 msec (by 200 msec). Enter the time in "Relay Control Settings." • 3 to 600 sec: Select this to set a time between 3 and 600 sec (by 1 sec). Enter the time in "Relay Control Settings." 	400 msec.

How to configure Relay Output Schedule (Daily Schedule)

Configure the time to perform the relay output, for each day. One year from the set day can be configured. 12 schedules can be set for each day.

- (1) On the Relay Output Settings screen, tap **[Relay Output 1 Schedule]** or **[Relay Output 2 Schedule]**.
 - The Relay Output Schedule screen will be shown. It may take some time.
- (2) Tap the day to set a schedule.

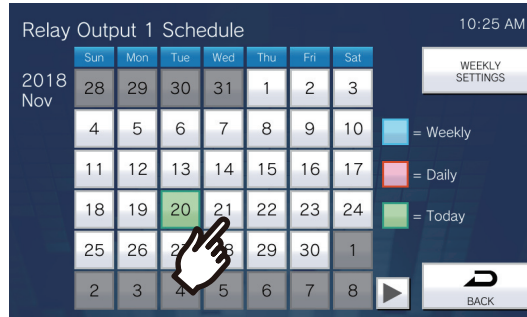

– The Daily Schedule screen will be shown for the day that was tapped.

- (3) Tap **[NEW]**.
 - *To change a registered schedule, tap the row to change, and tap **[EDIT]**.
 - *To delete a registered schedule, tap the row to delete, and tap **[DELETE]**.
 - *To delete all daily schedules of the displayed day, tap **[DELETE ALL]**.
 - *Refer to [“How to configure Relay Output Schedule \(Weekly Schedule\) \(→page 143\)”](#) for changing and deleting schedules registered as Weekly Schedule.

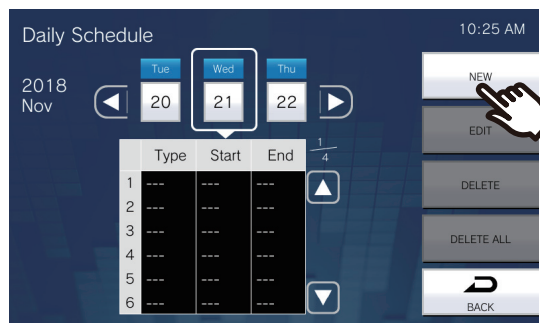

– The Set Daily Schedule screen will be shown.

- (4) Configure **[Start]** and **[End]**.

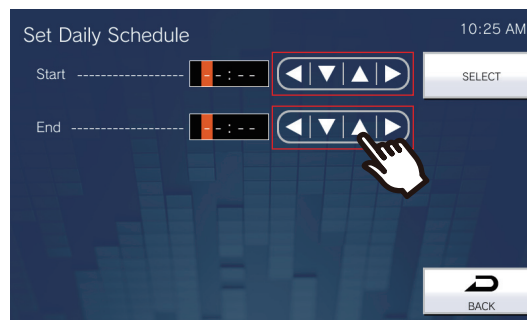

- (5) Tap **[SELECT]**.
 - The settings will be saved.

Entry	Description	Settings	Default values
Start	Set the time to start the relay output.	00:00 - 23:59	-
End	Set the time to end the relay output. If this is set earlier than "Start," the end time will be for the following day.	00:00 - 23:59	-

How to configure Relay Output Schedule (Weekly Schedule)

Configure the time to perform relay output for each day of the week, from Sunday to Saturday. 12 schedules can be set for each day of the week.

- (1) On the Relay Output Settings screen, tap **[Relay Output 1 Schedule]** or **[Relay Output 2 Schedule]**.
 - The Relay Output Schedule screen will be shown.
- (2) Tap **[Weekly Schedules]**.



– The Weekly Schedules screen will be shown.

- (3) Tap the day of the week to configure a schedule.

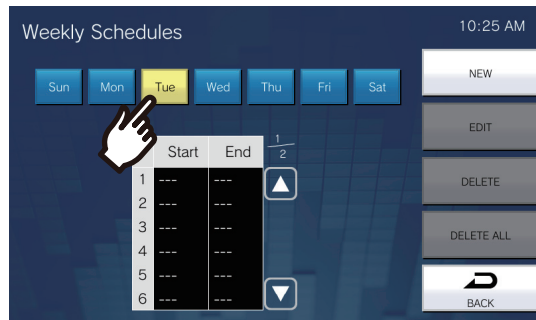

- (4) Tap **[NEW]**.

*To change a registered schedule, tap the row to change, and then tap **[EDIT]**.

*To delete a registered schedule, tap the row to delete, and then tap **[DELETE]**.

*To delete all weekly schedules of the displayed day of the week, tap **[DELETE ALL]**.

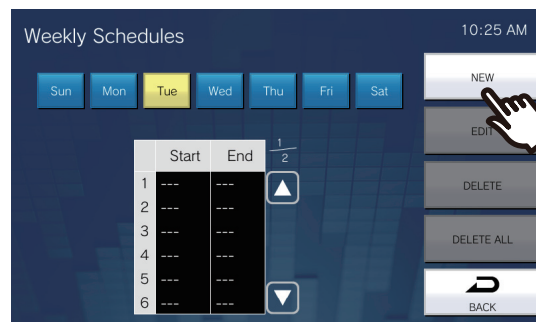

– The Set Weekly Schedule screen will be shown.

(5) Configure **[Start]** and **[End]**.

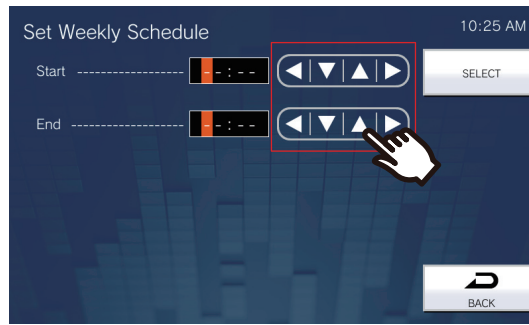

Entry	Description	Settings	Default values
Start	Set the time to start the relay output.	00:00 - 23:59	-
End	Set the time to end the relay output. If this is set earlier than "Start," the end time will be for the following day.	00:00 - 23:59	-

(6) Tap **[SELECT]**.
 – The settings will be saved.

Volume Settings

Configure settings related to volume and operation sounds.

1. Tap **[Volume]** on the Settings (2/2) screen.

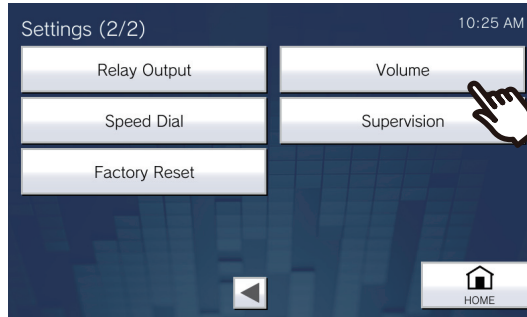

- The Volume Settings (1/2) screen will be shown.

2. Configure the settings.

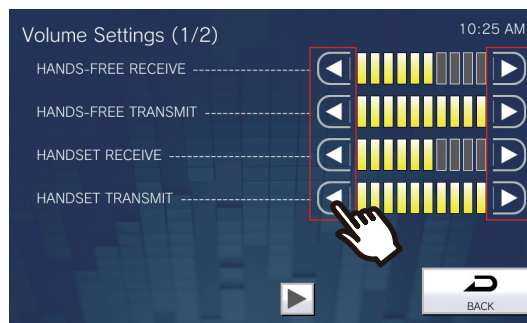

- Tapping **[BACK]** will save the settings.

Entry	Description	Settings	Default values
HANDS-FREE RECEIVE	Set the hands-free receive volume while communicating and paging. Also sets ringback tone volume.	1 - 10	6
HANDS-FREE TRANSMIT	Set the hands-free transmit volume while communicating and paging.	1 - 10	10
HANDSET RECEIVE	Set the receive volume using handset while communicating. Also sets ringback tone volume.	1 - 10	6
HANDSET TRANSMIT	Set the transmit volume using handset while communicating and paging.	1 - 10	10

3. Tap .
 - The settings will be saved.

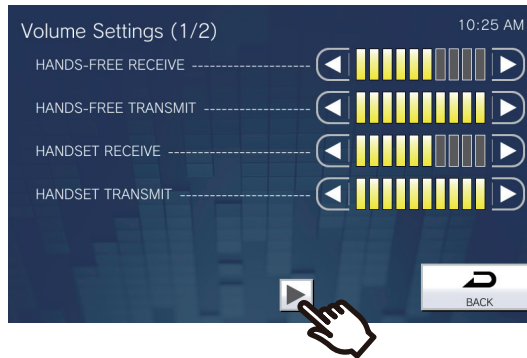

- The Volume Settings (2/2) screen will be shown.

4. Change the settings.

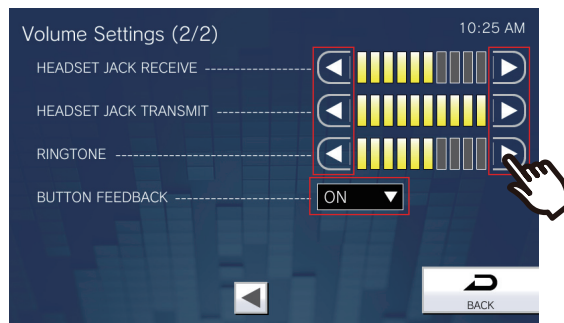

5. Tap **[Back]**.
 - The settings will be saved.

Entry	Description	Settings	Default values
HEADSET JACK RECEIVE	Set the receive volume using the headset jack.	1 - 10	6
HEADSET JACK TRANSMIT	Set the transmit volume while communicating and being monitored.	1 - 10	10
RINGTONE	Select the volume for Ringtone and Paging Pretone. The ringtone will sound at that volume, each time the setting value is changed.	0: Mute, 1 - 10	6
BUTTON FEEDBACK	Select Enable / Disable for Button Feedback tone.	<ul style="list-style-type: none"> • ON • OFF 	ON

Speed Dial Settings

Configure settings related to the Speed Dial buttons.

*This is an administrator privileges setting. If configuring the Speed Dial buttons is restricted, this cannot be configured under user privileges.

1. Tap **[Speed Dial]** on the Settings (2/2) screen.

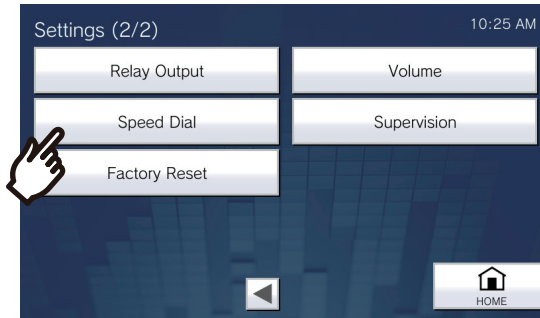

- The Speed Dial Settings screen will be shown.

2. Tap the Speed Dial button to configure, and then tap **[EDIT]**.

*To delete the setting for a registered Speed Dial button, tap the Speed Dial button to delete, and tap **[DELETE]**.

*To delete the settings for all registered Speed Dial buttons, tap **[DELETE ALL]** (administrator privileges only).

*Touching  next to a Speed Dial button under administrator privileges will change it to , preventing the setting from being changed under user privileges. Tap  to cancel this restriction.

- If a Speed Dial button is grayed out under user privileges, it has been restricted under administrator privileges and cannot be configured.

Administrator privileges

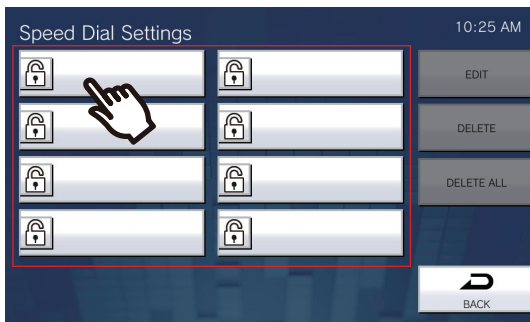

User privileges

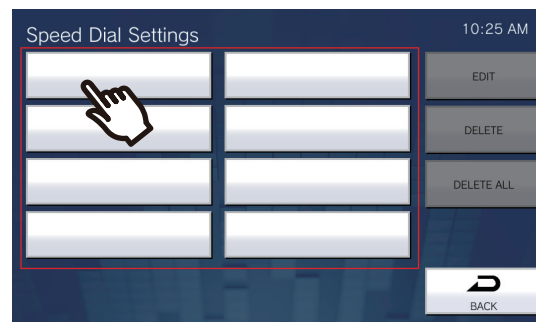

- The Speed Dial Settings (Advanced) screen will be shown.

3. Configure the function to assign.

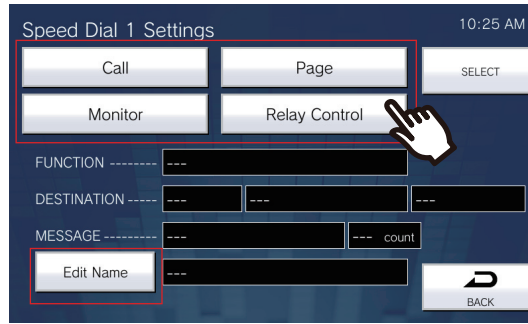

Entry	Description	Settings	Default values
Call	Assign the calling function to the Speed Dial button. Refer to “How to assign calling functions to Speed Dial buttons (→page 150)” for how to configure this.	-	-
Page	Assign the paging function to the Speed Dial button. Refer to “How to assign paging functions to Speed Dial buttons (→page 152)” for how to configure this.	-	-
Monitor	Assign the monitoring or scan monitoring function to the Speed Dial button. Scan monitoring cannot be assigned unless scan monitoring is configured in “Monitor Settings (→page 126)” . Refer to “How to assign monitoring functions to Speed Dial buttons (→page 154)” for how to configure this.	-	-
Relay Control	Assign optional relay (a function that controls the output terminal of another station) to the Speed Dial button. Refer to “How to assign Relay Control functions to Speed Dial buttons (→page 155)” for how to configure this.	-	-

4. Tap [Edit Name].

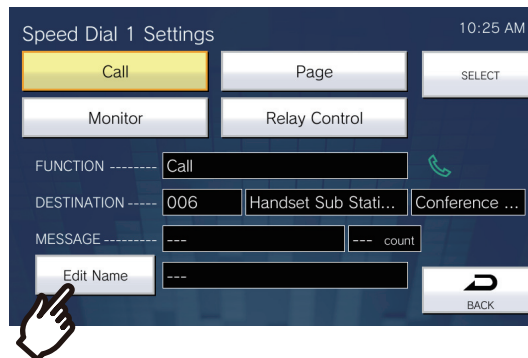

5. Enter the Speed Dial Button Name.
 - Refer to [“Entering Text \(→page 20\)”](#) for how to enter characters.

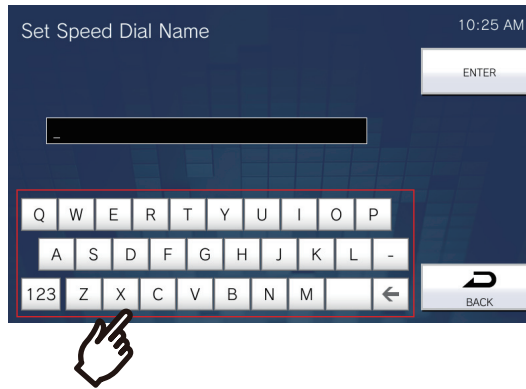

Entry	Description	Settings	Default values
Edit Name	Configure the name of the Speed Dial button.	1-24 alphanumeric characters (configure the “Speed Dial Name (→page 213)” PC setting to enter full-width characters). The configured name will be displayed on the Favorites button. The entire name may not be displayed, depending on the type of Home screen and number of characters.	-

6. Tap **[ENTER]**.
 - The Speed Dial Settings (Advanced) screen will be shown.

7. Confirm the details of the configured Speed Dial button, and then tap **[SELECT]**.
 - Tap **[BACK]** to return to the Speed Dial Settings screen without saving settings.

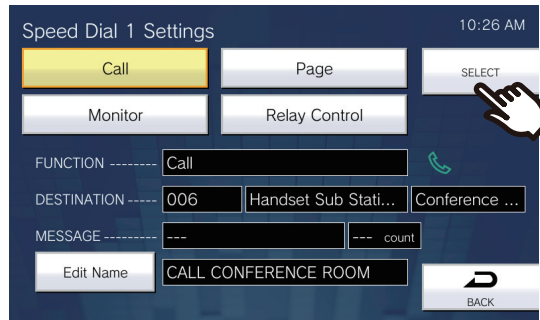

- The configured name will be displayed on the Favorites button. The entire name may not be displayed, depending on the type of Home screen and number of characters.
- Display the Speed Dial Settings screen. The configured buttons are displayed as shown in the screen below.

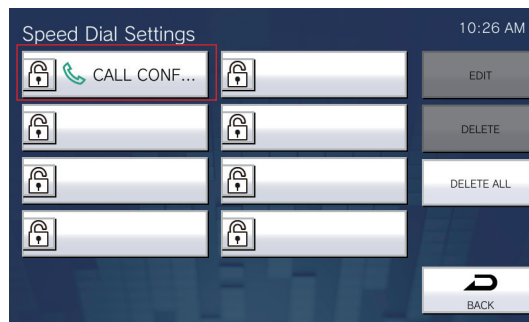

How to assign calling functions to Speed Dial buttons

- (1) On the Speed Dial Settings (Advanced) screen, tap **[Call]**.

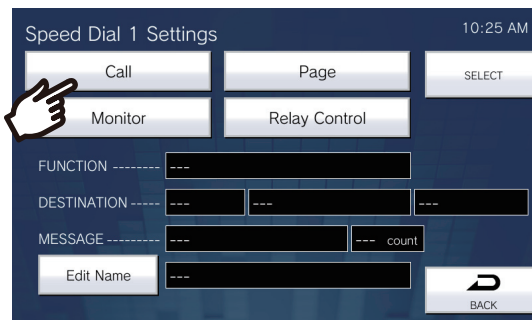

- The Address Book will be shown.
- (2) Tap the destination station to set to the Speed Dial button.
 - Refer to [“Searching for stations \(→page 32\)”](#) to search stations or groups.
 - Tap **[DIAL]** to specify by station/group number. Refer to [“Selecting / Choosing / Calling by Number \(→page 30\)”](#).

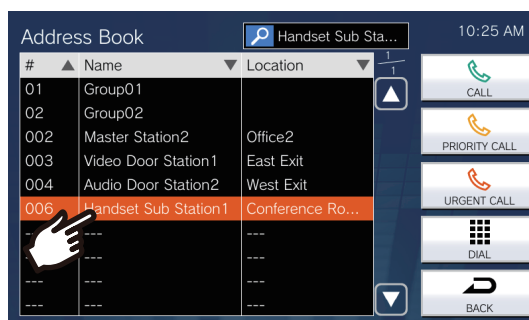

- (3) Tap **[CALL]**, **[PRIORITY CALL]**, or **[URGENT CALL]** to select the call priority.

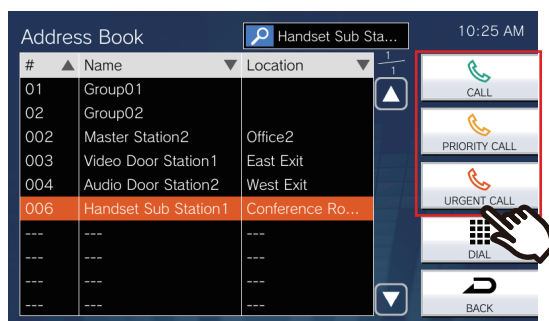

- The Speed Dial Settings (Advanced) screen will be shown.
- (4) Tap **[SELECT]**.
- The settings will be saved.

How to assign paging functions to Speed Dial buttons

- (1) On the Speed Dial Settings (Advanced) screen , tap **[Page]**.

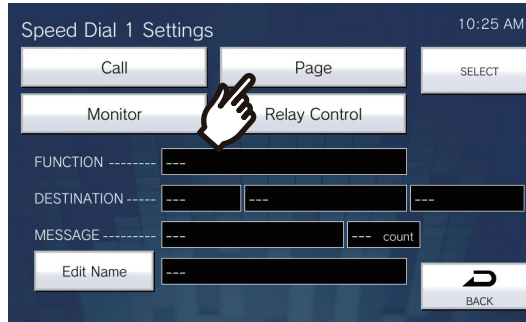

- (2) Tap the group to page using the Speed Dial button.
 - Refer to [“Searching for stations \(→page 32\)”](#) to search for groups.
 - To send an all page, tap **“[ALL PAGE].”**

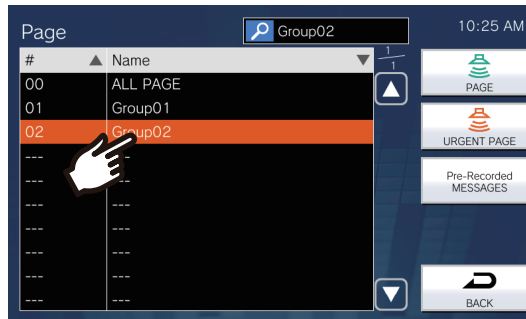

- (3) Select the type of paging from **[PAGE]**, **[URGENT PAGE]**, or **[Pre-Recorded MESSAGES]**.

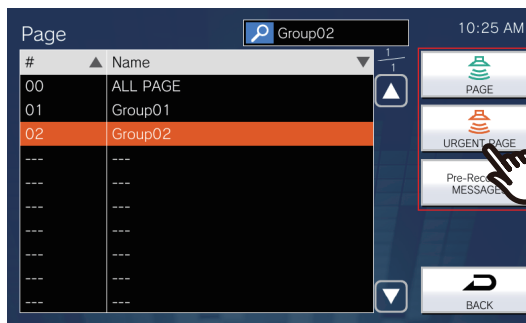

- The Speed Dial Settings (Advanced) screen will be shown.
- *If **[Pre-Recorded MESSAGES]** was selected, select "Play Count" and the paging tone file, and select the type of paging from **[PAGE]** or **[URGENT PAGE]**.
- Refer to [“Searching for stations \(→page 32\)”](#) to search file names.

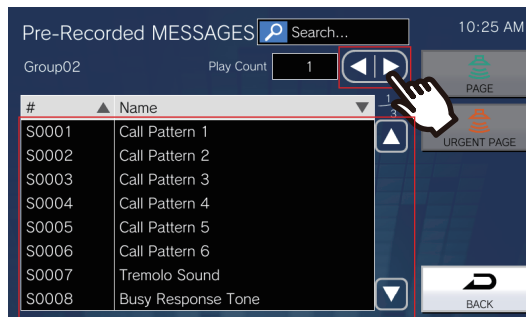

Entry	Description	Settings	Default values
Play Count	Set the message play count of message page.	1 - 20 times	1 time
Name	Select the message (audio file) to send during message paging.	<ul style="list-style-type: none"> • Call Pattern 1 • Call Pattern 2 • Call Pattern 3 • Call Pattern 4 • Call Pattern 5 • Call Pattern 6 • Tremolo Sound • Busy Response Tone • On Hold • Operation Sound • Error • Pre Tone 1 • Pre Tone 2 • Pre Tone 3 • Communication End Pretone • Call Queue Notification • Waiting Reply Tone • Select a sound that is registered in "Custom Sound Registry" (→page 172). 	-

- (4) Tap **[SELECT]**.
 – The settings will be saved.

How to assign monitoring functions to Speed Dial buttons

- (1) On the Speed Dial Settings (Advanced) screen, tap **[Monitor]**.

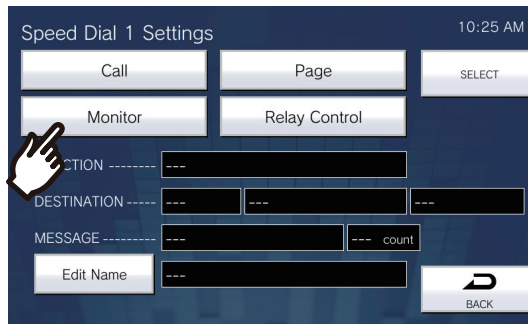

- (2) To assign the monitoring function, tap the station to monitor.
 - Refer to [“Searching for stations \(→page 32\)”](#) to search for stations.
 - *To assign the scan monitoring functions, follow the procedure from Step (3).

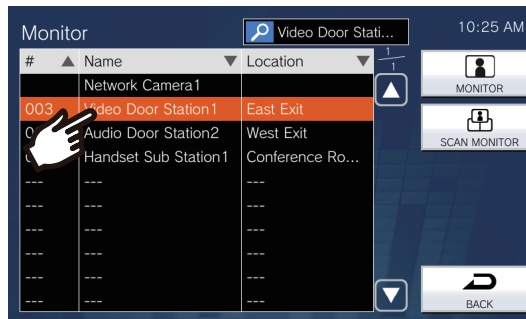

- (3) Select the type of monitoring from **[MONITOR]** or **[SCAN MONITOR]**.

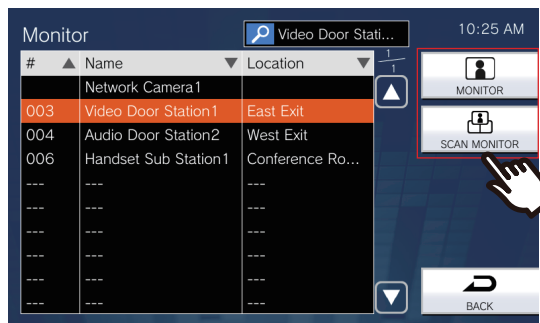

- (4) Tap **[SELECT]**.
 - The settings will be saved.

How to assign Relay Control functions to Speed Dial buttons

(1) On the Speed Dial Settings screen, tap [Relay Control].

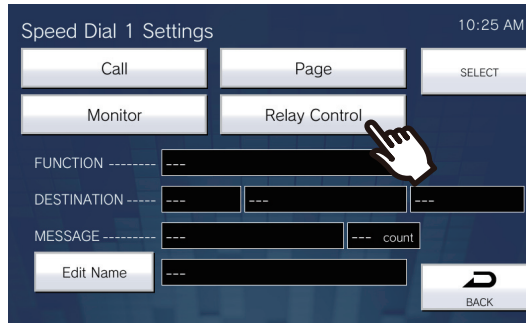

– The Set Destination Relay screen will be shown.

(2) Configure detailed settings.

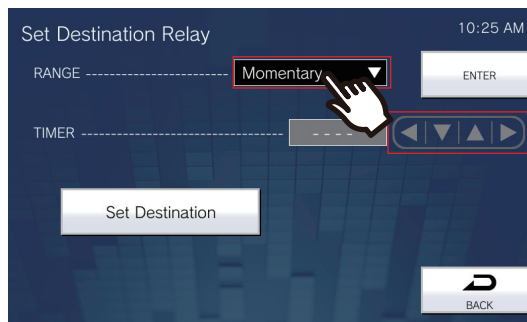

Entry	Description	Settings	Default values
TIMER (Relay Control Settings)	Select the Output Time Range for relay output, and set the Timer within the range.	<ul style="list-style-type: none"> • Momentary: The relay continues to output when the Speed Dial button is pressed. Pressing the Speed Dial button again stops relay output. • 200 to 2000 msec: Select this to set a time between 200 and 2000 msec (by 200 msec). Enter the time in "Relay Control Settings." • 3 to 600 sec: Select this to set a time between 3 and 600 sec (by 1 sec). Enter the time in "Relay Control Settings." 	Momentary

- (3) Tap **[Set Destination]**.

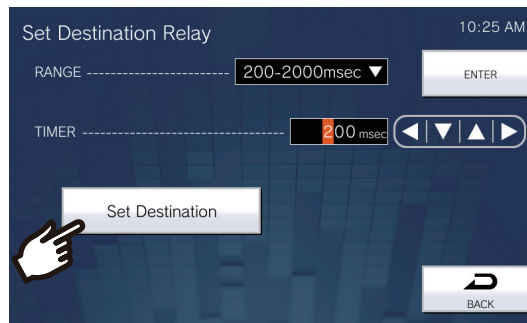

– The Set Destination Relay screen will be shown.

- (4) Tap **[NEW]** to configure the station to control the Relay Output.
 *To change a registered station, tap the station to change, and tap **[EDIT]**.
 *To delete a registered station, tap the station to delete, and tap **[DELETE]**.



– The Set Destination screen will be shown.

- (5) Tap the station to control the Relay.
 *Refer to [“Searching for stations \(→page 32\)”](#) to search for stations.
 (6) Tap **[ENTER]**.

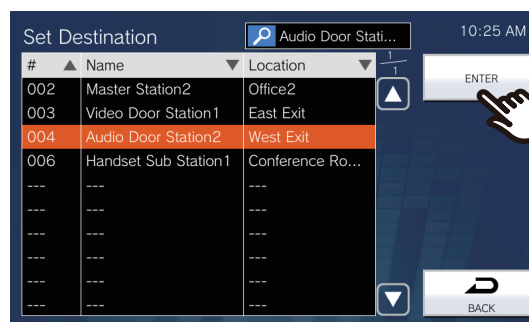

– The Set Destination Relay screen will be shown.

(7) Tap [ENTER].

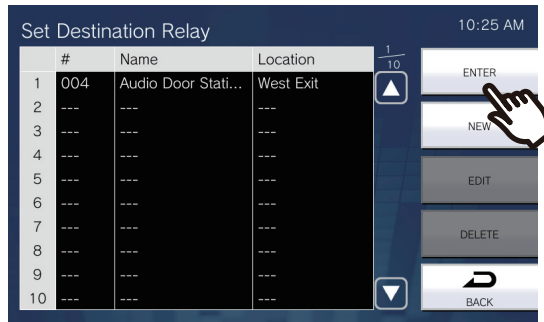

– The Set Destination Relay screen will be shown.

(8) Tap [ENTER].

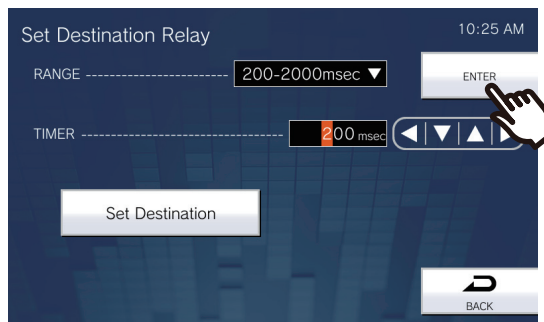

(9) Tap [SELECT].

– The settings will be saved.

Supervision Settings (administrator privileges only)

Configure details for automatic Line Supervision and Device Check.

1. Tap **[Supervision]** on the Settings (2/2) screen.

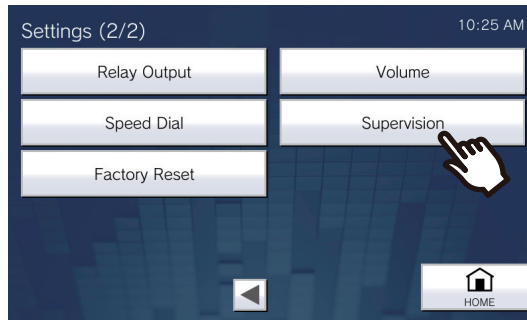

- The Supervision Settings screen will be shown.

2. Configure the settings.

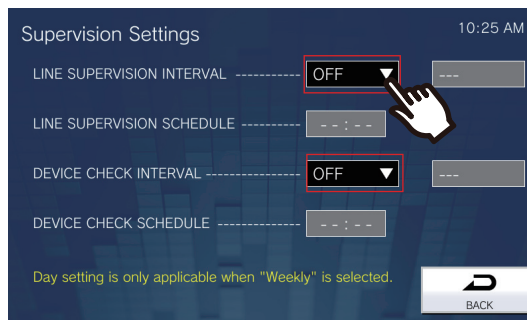

- 3.** Tap **[BACK]**.
- The settings will be saved.

Entry	Description	Settings	Default values
LINE SUPERVISION INTERVAL	Set the Line Supervision test interval.	<ul style="list-style-type: none"> • OFF • 15sec • 20min • 30min • 60min • 1 day • Weekly: Select from the day of week drop-down list. 	OFF
LINE SUPERVISION SCHEDULE	Set the time when automatic line monitoring starts. Set the time when "1 day" or "Weekly" is selected in "LINE SUPERVISION INTERVAL."	00:00-23:59	-
DEVICE CHECK INTERVAL	Set the Line Supervision test interval.	<ul style="list-style-type: none"> • OFF • 10min • 20min • 30min • 60min • 1 day • Weekly: Select from the day of week drop-down list. 	OFF
DEVICE CHECK SCHEDULE	Set the time when automatic failure monitoring starts. Set the time when "1 day" or "Weekly" is selected in "DEVICE CHECK INTERVAL."	00:00-23:59	-

Factory Reset

The settings of the station can be reset to default settings.

1. Tap **[Factory Reset]** on the Settings (2/2) screen.
 - The confirmation screen will be shown. Follow the procedure from Step 3.
 - With administrator privileges, the Factory Reset screen in Step 2 will be shown.

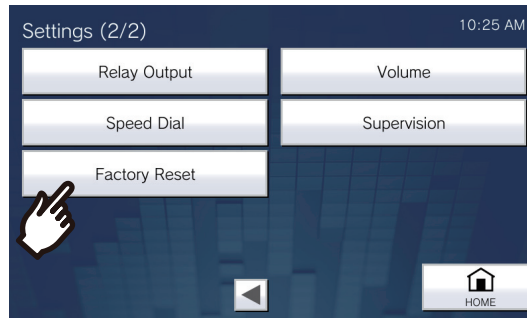

2. Tap **[Default User Settings]** or **[Factory Reset]**.

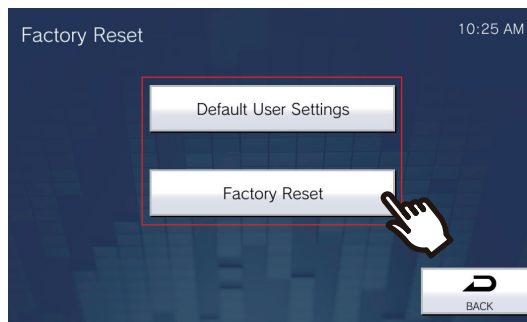

3. Confirm the information on the screen, and tap **[Yes]**.
 - To cancel initializing, tap **[No]**.

Example: Default User Settings with user privileges

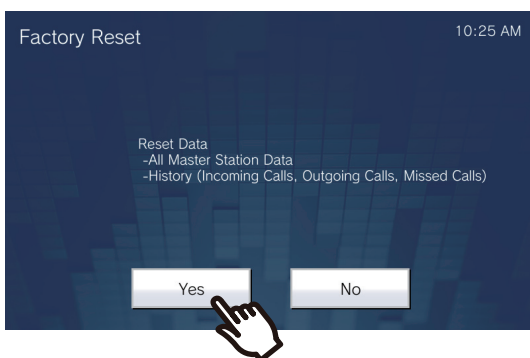

Example: Factory Reset

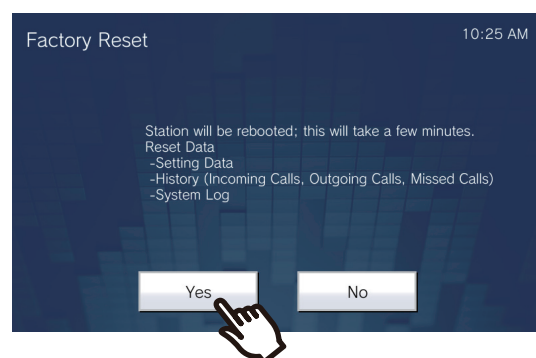

- The Home screen will be shown once initialization is complete.

Entry	Description
Default User Settings	Settings in " Settings on the station (→page 91) " will be initialized. Settings restricted under administrator privileges will not be initialized. The Incoming/Outgoing/Missed calls history will also be cleared.
Factory Reset (administrator only)	All settings will be initialized, and the system log and Incoming/Outgoing/Missed calls history will be cleared.

Important

- When "[**Factory Reset**]" is selected and the settings are initialized, it may take around 10 minutes to finish restarting. The station cannot be used until it has finished restarting.
- Video/audio files and monitoring results files saved to the microSD card will not be deleted. To delete video/audio files, do so from the history ([page 34](#)). Delete monitoring results files directly from the microSD card.

Station Programming

Connect to the same network as the Door Station and manage the settings from PC web browser.

System requirements

The programming PC must meet the following requirements to proceed.

Network	Ethernet (10BASE-T, 100BASE-TX)
Web browser	Microsoft Edge / Internet Explorer 10.0, 11.0 / Mozilla Firefox 59 or 60 (TLS1.0, 1.1, or 1.2 enabled)

Connecting to a PC

Using a Cat5e/6 "Straight-Through" cable, connect the station and PC to the same PoE switch or injector. Use CAT5e/6 straight cable to connect the devices through LAN port.

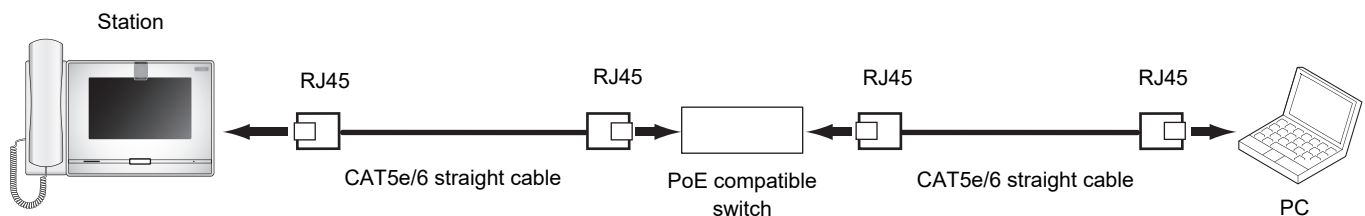

Login to this station

1. Start the PC and open one of the before mentioned web browsers.
2. Enter the address below into the web browser address bar.
 IPv4 example - <https://IP address of this device/webset.cgi?login>
 IPv6 example - [https://\[IP address of this device\]/webset.cgi?login](https://[IP address of this device]/webset.cgi?login)
 - If a certificate error window is displayed, click **[Go on to the webpage]**. To prevent it from appearing, the administrator will need to disable it. Contact your system administrator.
 - Language selection window will be displayed.

3. Select a language



4. Enter the ID and password, and then click [Login].

- Default values
 - ID: user
 - Password: user

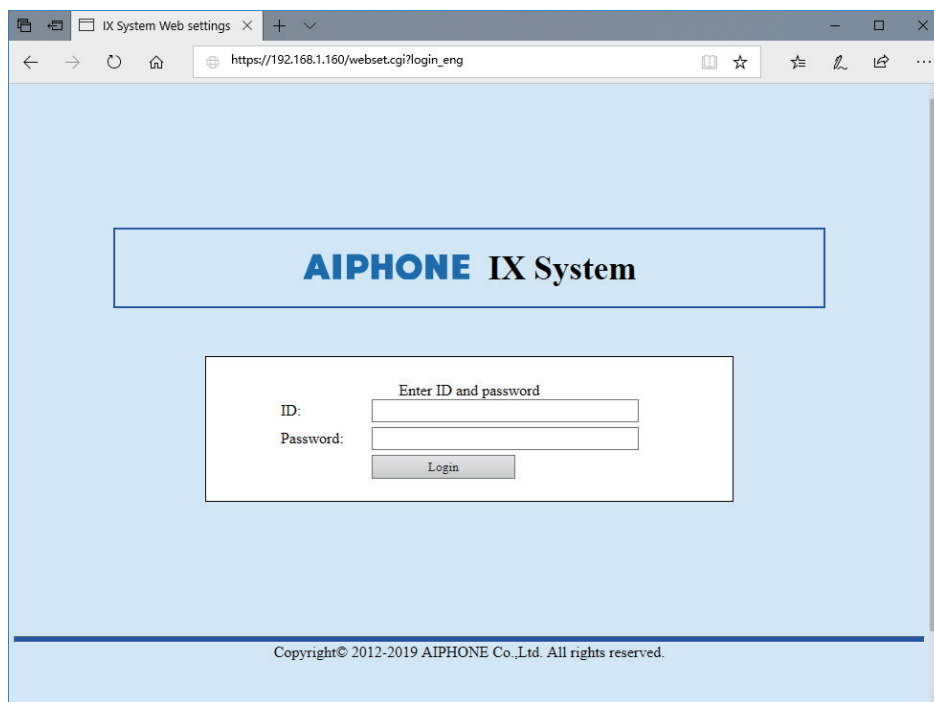



Note

- Do not login multiple times using multiple browsers at one time on the same PC.
- The default IP address and Subnet mask values are below:
 - IP Address: 192.168.1.160
 - Subnet Mask: 255.255.255.0
- Contact the system administrator if the IP address or subnet mask for the device is not known.

Setting window

When accessing the web server of the station, the following setting window will appear. The station can be configured in this window.

- Depending on PC and OS being used, the window may be slightly different.
- After configuring the station, confirm its operation by referring to the "Operation Manual (this document)."

<Settings screen example>

Setting window:

This indicates the setting window of the title selected.

Update button

Click this button to update the station settings.

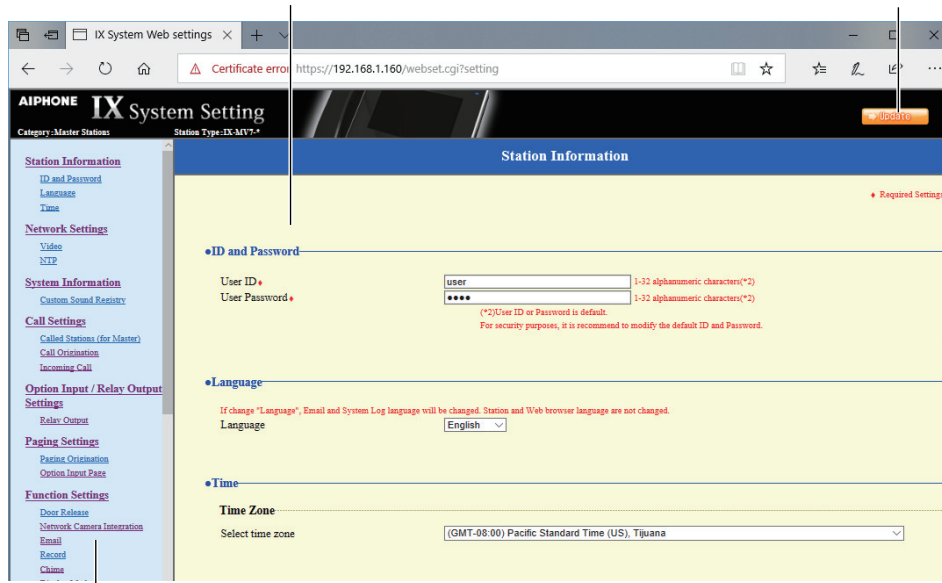

Setting menu:

Shows all items that can be configured. Click the title to be configured and the appropriate setting window will display.

How to configure

1. Click the title to configure in the setting menu
 - The setting window for that particular title will be shown.
2. Configure each setting item
3. When you are done making changes, click **[Update]** to update the settings
 - When the settings are updated, **[Settings updated.]** will be shown at the top left corner in the window.
 - If an update fails, an error message will be shown.
 - To cancel any changes, click another title in the setting menu.
 - Do not remove power to the station while updating.
4. Repeat the steps 1 to 3 for other settings
 - To log out of the station, click **[Log out]** in the settings menu.



Note

- To exit the station's web setting, click **[Log out]** and do not close the browser window by clicking **[X]**. If **[Log out]** is not used, it will be unable to login for approximately 1 hour.
- If the setting window switch to another without clicking **[Update]**, the settings will not be saved.
- When no activity is detected for one hour, the connection will be automatically terminated.

Station Information

ID and Password

•ID and Password

User ID 1-32 alphanumeric characters(*2)

User Password 1-32 alphanumeric characters(*2)

(*2)User ID or Password is default.
For security purposes, it is recommend to modify the default ID and Password.

Entry	Description	Settings	Default values
User ID*1	Set the ID for logging in to the Web System Setting Server.	1 - 32 alphanumeric characters	user
User Password*1	Set the password for logging in to the Web System Setting Server.	1 - 32 alphanumeric characters	user

*1 Indicates a required field. Use the default values, unless a change is necessary.

Note

- The "Administrator ID" (administrator setting) and "User ID" cannot be identical.
- The "User Password" is displayed as "•••••" on the screen.

Language

•Language

If change "Language", Email and System Log language will be changed. Station and Web browser language are not changed.

Language

Entry	Description	Settings	Default values
Language	Select the language for email and system log language. <ul style="list-style-type: none"> • Language used for various settings (including the station name) • Language used for email and system log 	<ul style="list-style-type: none"> • Japanese • English • French • Spanish • Dutch • Traditional Chinese • Simplified Chinese 	English

Note

- When logging in to web configuration with the station in its default state at the first time, the language will be set to the same language that was selected when logging in.

Time

! Important

- If the power is turned off for at least 30 minutes, the time and date will revert back to the default setting. If this happens, set the time and date again.

■ Time Zone

Entry	Description	Settings	Default values
Select time zone	Set the Time Zone.	Select from 99 regions	(GMT-08:00) Pacific Standard Time (US), Tijuana

💡 Note

- When logging in to web configuration with the station in its default state at the first time, this will be set as follows depending on the language selected when logging in.
 Japanese: (GMT+09:00) Osaka, Sapporo, Tokyo
 English: (GMT-08:00) Pacific Standard Time (US), Tijuana
 French: (GMT+01:00) Brussels, Madrid, Copenhagen, Paris
 Spanish: (GMT+01:00) Brussels, Madrid, Copenhagen, Paris
 Dutch: (GMT+01:00) Amsterdam, Berlin, Bern, Rome, Stockholm
 Traditional Chinese: (GMT+08:00) Taipei
 Simplified Chinese: (GMT+08:00) Beijing, Chongqing, Hong Kong, Urumqi

■ Daylight Savings Time

Entry	Description	Settings	Default values
Enable automatic daylight savings time	The daylight saving time is set automatically according by region selected in "Select time zone".	<ul style="list-style-type: none"> • Yes • No 	No

■ Date and Time

Clicking **[Update]** will not update the date and time settings on this station.

Press **[Apply Time to Station]** to update.

Entry	Description	Settings	Default values
Set date and time	Set the current time for the station. This is a required setting.	2017/1/1/00:00:00 - 2037/12/31/23:59:59 [Sync with PC]: Synchronized with the current time setting of the PC.	The time from 2018/1/1/00:00:00 with the time difference set in "Select time zone" applied

Network Settings

Video

•Video

Master Station Video Setting

Video Streaming Enable Disable

Frame Rate [fps]

Select Profile

I-picture interval* 1-100

Bit Rate [kbps] [H.264/AVC]

! Important

- When sending video to a VoIP Phone, configure the same video settings as the VoIP Phone.
- Video is not sent when making an outgoing call to a VoIP Phone.
- When the "Frame Rate" is set to 7.5, 10, 15, 20 or, 30 fps, after approximately 10 minutes following the start of an outgoing call, the frame rate will automatically drop to 5 fps.

💡 Note

- The frame rate or bit rate may be lower than the set value depending on the video being sent, the number of recipient stations, and the network environment.

■ Master Station Video Setting

Entry	Description	Settings	Default values
Video Streaming	Select Enable / Disable for Video Streaming of IX-MV7-*. Video cannot be distributed to 3rd party products not compatible with ONVIF or to IX-MV. The Video Codec is H.264 / AVC.	<ul style="list-style-type: none"> • Enable • Disable 	Enable
Frame Rate [fps]	Set the Frame Rate [fps].	0.5, 1, 2, 3, 5, 7.5, 10, 15, 20, 30	15
Select Profile	Set the profile for Video Streaming.	<ul style="list-style-type: none"> • Baseline • Main • High 	Main
I-picture interval* ¹	Select the interval to send I-picture for Video Streaming.	1 - 100	15
Bit Rate [kbps] [H.264/AVC]	Select the bit rate [kbps].	32, 64, 128, 256, 384, 512, 768, 1024, 2048	1024

*1 Indicates a required field. Use the default values, unless a change is necessary.

NTP

•NTP

Enable NTP Yes No Use

■ Enable NTP

Entry	Description	Settings	Default values
Enable NTP	Enable NTP server to retrieve the time. Configuring NTP server is required separately if using an NTP server. Contact your system administrator.	<ul style="list-style-type: none">• Yes• No Use	No Use

System Information

Custom Sound Registry

Register a maximum of 100 audio files to be used for call acknowledged tones. (total length should not exceed approximately 200 seconds).

Supported file format

- File Type: .wav
- File name: Within 41 characters (excluding extension)
For audio files used for message paging, messages when paging are searched by letter or number, so enter a letter or number as the first character.
- Sample Size: 16 bits
- Sample Rate: 8 kHz and 16 kHz
8 kHz (when "Audio Codec" is set to "G.711 (μ-Law)" or "G.711 (A-Law)")
16 kHz (when "Audio Codec" is set to "G.722")
Contact the system administrator for information on the audio codec.
- Channel: 1 (mono)

 **Note**

- If using a file for a ringback tone, ringtone, or network camera event tone, add a period of silence in the .wav file if the tone is to be intermittent.
- Sample files of custom tones are provided on our website (<https://www.aiphone.net/support/>) for download. Use the files in it as audio sources.

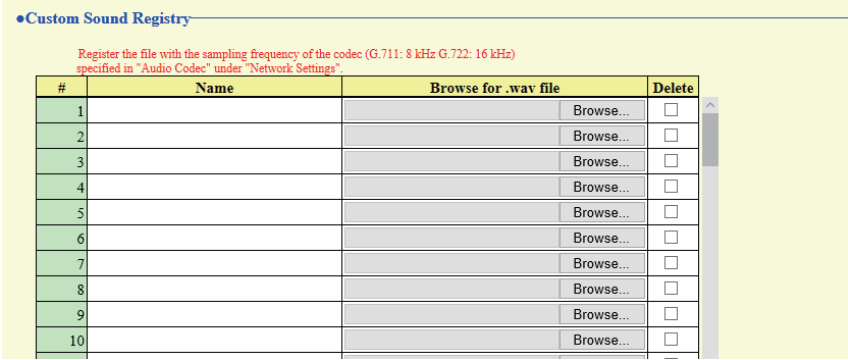

How to register an audio file

1. Click **[Browse]** at the end of the row for the station in which the file is to be registered.
2. Select the audio file to register, and click **[Open]**.
 - Name: The name of the registered file is shown.
The name will be shown as the setting value when configuring the ringtone etc.
 - Browse for .wav file: The audio file reference destination is shown.
3. Click **[Update]**.

How to delete a custom sound

1. Check the **[Delete]** box of the audio file to delete.
2. Click **[Update]**.

Call Settings

Call Stations (for Master)

Stations in the "Address Book" (administrator setting) may be called.

Call Origination

• Call Origination

Call Origination Settings

Call Destination Group Number must be 01-99.

	Call Button	Option Input 1	Option Input 2	Option Input 3
Ringback Tone	Call Pattern 4	Call Pattern 4	Call Pattern 4	Call Pattern 4
Call Timeout	10-600 sec 60 sec	10-600 sec 60 sec	10-600 sec 60 sec	10-600 sec 60 sec
Ringback Tone Count [time(s)]	Infinite	Infinite	Infinite	Infinite
Call Destination	-			
Priority	-	Normal	Normal	Normal

Tone Settings

Busy Tone: Busy Response Tone

(*) Tone generated at door release destination station.

■ Call Origination Settings (Call Button)

Entry	Description	Settings	Default values
Ringback Tone	Select the sound to be played by the station when placing a call or monitoring.	<ul style="list-style-type: none"> • None • Call Pattern 1 • Call Pattern 2 • Call Pattern 3 • Call Pattern 4 • Call Pattern 5 • Call Pattern 6 • Tremolo Sound • Busy Response Tone • On Hold • Operation Sound • Error • Pre Tone 1 • Pre Tone 2 • Pre Tone 3 • Communication End Pretone • Call Queue Notification • Waiting Reply Tone • Select a sound that is registered in "Custom Sound Registry" (→page 172). 	Call Pattern 4
Call Timeout* ¹	Set the Call Timeout for outgoing call.	<ul style="list-style-type: none"> • 10 - 600 sec: Select to set between 10-600 sec (by 1 sec). • Infinite: Keep calling until call is answered. 	60sec

Entry	Description	Settings	Default values
Ringback Tone Count [time(s)]	Set the play count of ringback tone for outgoing call.	<ul style="list-style-type: none"> • 1 - 20 times • Infinite: The calling tone continues to play for the amount of time set in "Call Timeout." 	Infinite

*1 Indicates a required field. Use the default values, unless a change is necessary.

Note

- When calling a VoIP Phone, this will be the shorter time of the time set for "Call Timeout" and the call duration configured on the IP-PBX.

■ Call Origination Settings (outgoing call placed by Option Input 1 - 4)

Entry	Description	Settings	Default values
Ringback Tone	Select the sound to be played by the station when placing a call. via option input.	<ul style="list-style-type: none"> • None • Call Pattern 1 • Call Pattern 2 • Call Pattern 3 • Call Pattern 4 • Call Pattern 5 • Call Pattern 6 • Tremolo Sound • Busy Response Tone • On Hold • Operation Sound • Error • Pre Tone 1 • Pre Tone 2 • Pre Tone 3 • Communication End Pretone • Call Queue Notification • Waiting Reply Tone • Select a sound that is registered in "Custom Sound Registry" (→page 172). 	Call Pattern 4
Call Timeout*1	Configure the call timer for calls.	<ul style="list-style-type: none"> • 10 - 600 sec: Select to set between 10-600 sec (by 1 sec). • Infinite: Keep calling until call is answered. 	60sec
Ringback Tone Count [time(s)]	Set the play count of ringback tone for outgoing call.	<ul style="list-style-type: none"> • 1 - 20 times • Infinite: The calling tone continues to play for the amount of time set in "Call Timeout." 	Infinite
Call Destination	Configure the outgoing call destination group.	01 - 99	-
Priority	Set the priority of calls.	<ul style="list-style-type: none"> • Normal • Priority • Urgent 	Normal

*1 Indicates a required field. Use the default values, unless a change is necessary.

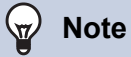

Note

- When calling a VoIP Phone, it will be the shorter time of the time set for "Call Timeout" and the call duration configured on the IP-PBX.

■ Tone Settings

Entry	Description	Settings	Default values
Busy Tone	Select the sound to be played when call destination station is busy.	<ul style="list-style-type: none"> • None • Call Pattern 1 • Call Pattern 2 • Call Pattern 3 • Call Pattern 4 • Call Pattern 5 • Call Pattern 6 • Tremolo Sound • Busy Response Tone • On Hold • Operation Sound • Error • Pre Tone 1 • Pre Tone 2 • Pre Tone 3 • Communication End Pretone • Call Queue Notification • Waiting Reply Tone • Select a sound that is registered in "Custom Sound Registry (→page 172)". 	Busy Response Tone

Incoming Call

Call Answer Settings

Incoming Call

Call Answer Settings

Auto Answer ON OFF

Entry	Description	Settings	Default values
Auto Answer	Select ON / OFF to automatically answer the individual call. Auto Answer: When receiving an individual call, answer automatically. When receiving a call from VoIP Phone and transferring a call, it must be answered manually.	<ul style="list-style-type: none"> • ON: Auto Answer enabled. • OFF: No Auto Answer. 	OFF

Ringtone

Ringtone

Call Button

Originating Station	Normal	Priority	Urgent
0001 004 Video Door Station4	Call Pattern 1	Call Pattern 1	Call Pattern 1
0002 001 Master Station1	Call Pattern 1	Call Pattern 1	Call Pattern 1
0003 008 Audio Door Station8	Call Pattern 1	Call Pattern 1	Call Pattern 1
0004 020 Master Station20	Call Pattern 1	Call Pattern 1	Call Pattern 1

Option Input

Originating Station	Normal	Priority	Urgent
0001 004 Video Door Station4	Call Pattern 2	Call Pattern 2	Call Pattern 2
0002 001 Master Station1	Call Pattern 2	Call Pattern 2	Call Pattern 2
0003 008 Audio Door Station8	Call Pattern 2	Call Pattern 2	Call Pattern 2
0004 020 Master Station20	Call Pattern 2	Call Pattern 2	Call Pattern 2

Call Button Ringtone Count [time(s)]

Option Input Ringtone Count [time(s)]

Entry	Description	Settings	Default values
Call Button	Select the ringtone for incoming call. Ringtone can be set per each source station.	<ul style="list-style-type: none"> • None • Call Pattern 1 • Call Pattern 2 • Call Pattern 3 • Call Pattern 4 • Call Pattern 5 • Call Pattern 6 • Tremolo Sound • Busy Response Tone • On Hold • Operation Sound • Error • Pre Tone 1 • Pre Tone 2 • Pre Tone 3 • Communication End Pretone • Call Queue Notification • Waiting Reply Tone • Select a sound that is registered in "Custom Sound Registry" (→page 172). 	Call Pattern 1
Option Input	Select the ringtone for incoming call by Option Input. The ringtone can be set per each source station.	<ul style="list-style-type: none"> • None • Call Pattern 1 • Call Pattern 2 • Call Pattern 3 • Call Pattern 4 • Call Pattern 5 • Call Pattern 6 • Tremolo Sound • Busy Response Tone • On Hold • Operation Sound • Error • Pre Tone 1 • Pre Tone 2 • Pre Tone 3 • Communication End Pretone • Call Queue Notification • Waiting Reply Tone • Select a sound that is registered in "Custom Sound Registry" (→page 172). 	Call Pattern 2
Call Button Ringtone Count [time(s)]	Set the play count of ringback tone for incoming call from call button.	<ul style="list-style-type: none"> • Infinite: Keep ringing until the call is answered or canceled. • 1-20 rings 	Infinite
Option Input Ringtone Count [time(s)]	Set the play count of ringback tone for incoming call from the option input.	<ul style="list-style-type: none"> • Infinite: Keep ringing until the call is answered or canceled. • 1-20 rings 	Infinite

■ VoIP Phone

VoIP Phone

VoIP Phone Call Priority

Entry	Description	Settings	Default values
VoIP Phone Call Priority	Select the call priority from VoIP Phone.	<ul style="list-style-type: none">• Normal• Priority• Urgent	Normal

Option Input / Relay Output Settings

Relay Output

•Relay Output

If the Relay Output number is changed, unsaved settings will be lost. Click Update to save settings.

Relay Output #

•Door Release Authorization
 Authentication Key
(*) 1-20 digits
 (*) Authentication Key must match between communicating stations to enable Door Release.

•Sound Settings
 Door Release
(*) Tone generated at door release destination station.

Relay Control (start)
(*) Tone generated at door release destination station.

Relay Control (end)
(*) Tone generated at door release destination station.

Option Relay Control Authentication Key: 1-20 digits

■ Relay output advanced settings

How to configure Relay Output

1. Select the relay output to configure in "Relay Output #."
 • The settings of the selected relay output will be displayed.
2. Configure each item.
3. Click **[Update]**.

Entry	Description	Settings	Default values
Authentication Key	Set the Authentication Key when "Door Release" is selected in "Function (administrator setting)" for releasing the door that is connected to the station. When the "Authentication Key" is confirmed, the relay output will be activated. This will also be the authentication key used to release the door using the keypad on IX-MV7-* or a VoIP phone.	1 - 20 digits	-

Entry	Description	Settings	Default values
Sound Settings	<ul style="list-style-type: none"> • Door Release: Select the Door Release sounds to be played. • Relay Control (start): Select the sound to be played when Option Relay is activated. • Relay Control (end): Select the sound to be played when Option Relay is deactivated. 	<ul style="list-style-type: none"> • None • Call Pattern 1 • Call Pattern 2 • Call Pattern 3 • Call Pattern 4 • Call Pattern 5 • Call Pattern 6 • Tremolo Sound • Busy Response Tone • On Hold • Operation Sound • Error • Pre Tone 1 • Pre Tone 2 • Pre Tone 3 • Communication End Pretone • Call Queue Notification • Waiting Reply Tone • Select a sound that is registered in "Custom Sound Registry" (→page 172). 	Door Release: Operation Sound Relay Control (start): None Relay Control (end): None

Important

- Configure the Authentication Key using 1 to 4 digits to release when using the IX-MV.
- Configure a different Authentication Key for each output terminal (the same key cannot be used.)
- Configure an Authentication Key that is different from the Authentication Key configured in "Option Relay Control Authentication Key." If the setting is the same, multiple functions might operate.

Note

- The "Authentication Key" is displayed as "●●●●" in the Settings screen.

■ Option Relay Control Authentication Key

Entry	Description	Settings	Default values
Option Relay Control Authentication Key	If "Option Relay Control (administrator setting)" is set to "Enable" and "Speed Dials / Favorites" - "TLS" is set to "Enable" on the requesting station, configure the key used to decrypt encrypted communication. If this matches the "Option Relay Control Key" of the station performing the operation, the Relay Output can be controlled.	1 - 20 digits	-

Note

- Only one Option Relay Control Authentication Key can be set for each station. It will be shared with multiple Relay Output.
- The "Option Relay Control Authentication Key" is displayed as "●●●●" in the Settings screen.

Paging Settings

! Important

- All pages, group pages, message pages, and external input pages cannot be sent to a VoIP Phone.

Paging Origination

•Paging Origination

Paging Timeout [sec] ♦	<input type="text" value="30"/>	10-600sec
Paging Wait Timer [sec] ♦	<input type="text" value="10"/>	1-20sec

Entry	Description	Settings	Default values
Paging Timeout [sec]*1	Set the time for outgoing paging duration.	10 - 600 sec (by 1 sec)	30 sec
Paging Wait Timer [sec]*1	Set the time to wait for a response from all destination stations when outgoing paging is activated. Paging starts after this time without a response form all destination.	1 - 20 sec (by 1 sec)	10 sec

*1 Indicates a required field. Use the default values, unless a change is necessary.

! Important

- A page may not be sent to a station if a response is received after the "paging wait timer" elapses. If multiple stations receive pages, configure a longer paging wait timer.

💡 Note

- Configure the pretone when a page is received in "Volume / Tone" - ["Paging Pretone \(→page 220\)"](#).

Option Input Page

Option Input Page. Configure this if the Option Input function (administrator setting) is set to "Paging," "Message Page," or "External Input Page."

•Option Input Page

To configure an Option Input Page, "Page", "Message Page", or "External Input Page" must be selected in Option Input settings.

Option Input #

•Destination	<input checked="" type="radio"/> All Page	<input type="radio"/> Group <input type="text" value=""/>	01-99
•Priority	<input checked="" type="radio"/> Normal	<input type="radio"/> Urgent	
•Message File Name	<input type="text" value="None"/>		
•Play Count [time(s)]	<input type="text" value="1"/>		

How to configure Option Input Page

1. Select the contact input to set for "Option Input #." This cannot be selected if "Paging," "Message Page," or "Message Page" is not set for contact input.
 - The settings of the selected contact input are displayed.
2. Configure each item.
3. Click **[Update]**.

Entry	Description	Settings	Default values
Destination	Set the destination group for paging.	<ul style="list-style-type: none"> • All Page • Group: 01-99 	All Page
Priority	Set the priority for paging.	<ul style="list-style-type: none"> • Normal • Urgent 	Normal
Message File Name	Select the message to be sent for message paging. Available when "Message Page" is selected in Option Input "Function (administrator setting)".	<ul style="list-style-type: none"> • None • Call Pattern 1 • Call Pattern 2 • Call Pattern 3 • Call Pattern 4 • Call Pattern 5 • Call Pattern 6 • Tremolo Sound • Busy Response Tone • On Hold • Operation Sound • Error • Pre Tone 1 • Pre Tone 2 • Pre Tone 3 • Communication End Pretone • Call Queue Notification • Waiting Reply Tone • Select a sound that is registered in "Custom Sound Registry (→page 172)". 	None
Play Count [time(s)]	Set the play count for message paging.	1-20 rings	1 time

Function Settings

Door Release

■ Door Release Assignment

● Door Release

Door Release Assignment

Station List	Contact Assignment	Authentication Key (* 1-20 digits)
0001 004 Video Door Station4	Destination Station ▼	<input type="text"/>
0002 001 Master Station1	Destination Station ▼	<input type="text"/>
0003 008 Audio Door Station8	Destination Station ▼	<input type="text"/>
0004 020 Master Station20	Destination Station ▼	<input type="text"/>

Entry	Description	Settings	Default values
Contact Assignment	Select which relay output will be used for door release during call or monitoring.	<ul style="list-style-type: none"> • Originating Station: Use origination station relay output for door release. • Destination Station: Use destination station relay output for door release. 	Destination Station
Authentication Key	When "Destination Station" is selected in "Contact Assignment", set the Authentication Key for door release. Authentication Key must match with the destination station's authentication key to allow door release.	1 - 20 digits	-

 **Note**

- The "Authentication Key" is displayed as "●●●●" in the Settings screen.
- Configure the door release key using 1 to 4 digits, when releasing an electrical lock connected to IX-MV, IX-DA(-*), or IX-BA.

Network Camera Integration

■ Event Registration

Settings configured under administrator privileges are displayed for items except for "Event Tone" and "Play count of Event Tone."

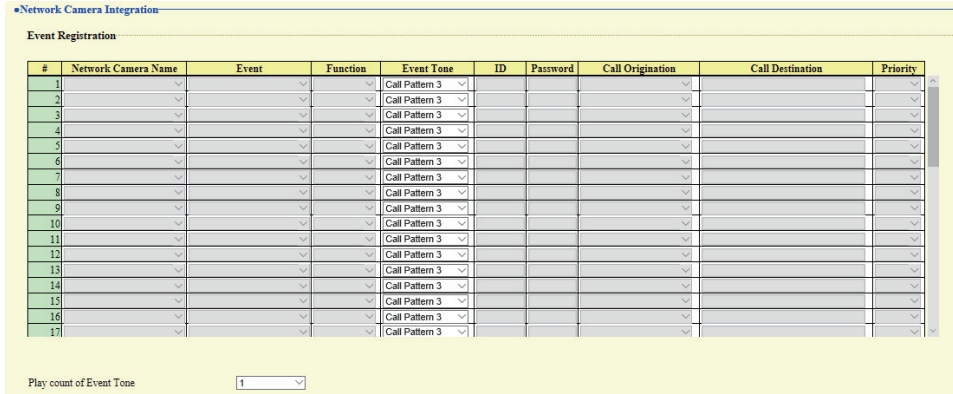

Entry	Description	Settings	Default values
Event Tone	Select the tone to be played when receiving event from the network camera. This can be configured for each event.	<ul style="list-style-type: none"> • None • Call Pattern 1 • Call Pattern 2 • Call Pattern 3 • Call Pattern 4 • Call Pattern 5 • Call Pattern 6 • Tremolo Sound • Busy Response Tone • On Hold • Operation Sound • Error • Pre Tone 1 • Pre Tone 2 • Pre Tone 3 • Communication End Pretone • Call Queue Notification • Waiting Reply Tone • Select a sound that is registered in "Custom Sound Registry" (→page 172). 	Call Pattern 3

■ Play count of Event Tone

Entry	Description	Settings	Default values
Play count of Event Tone	Set the play count for Network Camera Event Tone when Function is set to "Monitor." The ringtone count will be the same for all network cameras and events registered to the station. If "Call" is set, the ringtone count for the event notification tone will be one time only.	<ul style="list-style-type: none"> • 1-20 rings • Infinite: Play the ringtone while receiving an event that occurred on the network camera. 	1

Email

Configure this section when email notification of station operation is required.

Important

- If an SMTP server is not configured, email will not be sent even if email is configured. If email is not sent, contact the system administrator.

■ Email Addresses



Entry	Description	Settings	Default values
Destination 1 - Destination 3	Set the destination email address. Define up to three addresses.	1 - 64 alphanumeric characters	-

■ Email Event Trigger

Set up which event triggers will send an email message for each address.

Email Event Trigger

Event	Destination Address		
	(1)	(2)	(3)
Outgoing Normal Call	<input type="checkbox"/>	<input type="checkbox"/>	<input type="checkbox"/>
Incoming Normal Call	<input type="checkbox"/>	<input type="checkbox"/>	<input type="checkbox"/>
Outgoing Priority Call	<input type="checkbox"/>	<input type="checkbox"/>	<input type="checkbox"/>
Incoming Priority Call	<input type="checkbox"/>	<input type="checkbox"/>	<input type="checkbox"/>
Outgoing Urgent Call	<input type="checkbox"/>	<input type="checkbox"/>	<input type="checkbox"/>
Incoming Urgent Call	<input type="checkbox"/>	<input type="checkbox"/>	<input type="checkbox"/>
Door Release Activated	<input type="checkbox"/>	<input type="checkbox"/>	<input type="checkbox"/>
Call Failed	<input type="checkbox"/>	<input type="checkbox"/>	<input type="checkbox"/>
Error	<input type="checkbox"/>	<input type="checkbox"/>	<input type="checkbox"/>
Station Restarted	<input type="checkbox"/>	<input type="checkbox"/>	<input type="checkbox"/>
SD Card Error	<input type="checkbox"/>	<input type="checkbox"/>	<input type="checkbox"/>
Recording Memory Full	<input type="checkbox"/>	<input type="checkbox"/>	<input type="checkbox"/>
Line Supervision (Passed)	<input type="checkbox"/>	<input type="checkbox"/>	<input type="checkbox"/>
Line Supervision (Failed)	<input type="checkbox"/>	<input type="checkbox"/>	<input type="checkbox"/>
Device Check (Passed)	<input type="checkbox"/>	<input type="checkbox"/>	<input type="checkbox"/>
Device Check (Failed)	<input type="checkbox"/>	<input type="checkbox"/>	<input type="checkbox"/>

[UTF-8] used for "Subject" encoding, the subject may be incorrectly decoded depending on mail server.

Event	Subject <small>1-64 alphanumeric characters</small>
Outgoing Normal Call	
Incoming Normal Call	
Outgoing Priority Call	
Incoming Priority Call	
Outgoing Urgent Call	
Incoming Urgent Call	
Door Release Activated	
Call Failed	
Error	
Station Restarted	
SD Card Error	
Recording Memory Full	
Line Supervision (Passed)	
Line Supervision (Failed)	
Device Check (Passed)	
Device Check (Failed)	

Entry	Description	Settings	Default values
Outgoing Normal Call	Send email when an outgoing call is placed at "Normal" priority.	<ul style="list-style-type: none"> • Checked: Send • Unchecked: Do not send 	Unchecked: Do not send
Incoming Normal Call	Send email when an incoming call is received at "Normal" priority.	<ul style="list-style-type: none"> • Checked: Send • Unchecked: Do not send 	Unchecked: Do not send
Outgoing Priority Call	Send email when an outgoing call is placed at "Priority" priority.	<ul style="list-style-type: none"> • Checked: Send • Unchecked: Do not send 	Unchecked: Do not send
Incoming Priority Call	Send email when an incoming call is received at "Priority" priority.	<ul style="list-style-type: none"> • Checked: Send • Unchecked: Do not send 	Unchecked: Disable
Outgoing Urgent Call	Send email when an outgoing call is placed at "Urgent" priority.	<ul style="list-style-type: none"> • Checked: Send • Unchecked: Do not send 	Unchecked: Do not send
Incoming Urgent Call	Send email when an incoming call is received at "Urgent" priority.	<ul style="list-style-type: none"> • Checked: Send • Unchecked: Do not send 	Unchecked: Do not send

Entry	Description	Settings	Default values
Door Release Activated	Send email when Door Release is activated.	<ul style="list-style-type: none"> • Checked: Send • Unchecked: Do not send 	Unchecked: Do not send
Call Failed	Send email when outgoing call has failed.	<ul style="list-style-type: none"> • Checked: Send • Unchecked: Do not send 	Unchecked: Do not send
Error	Send email when a communication error has occurred.	<ul style="list-style-type: none"> • Checked: Send • Unchecked: Do not send 	Unchecked: Do not send
Station Restarted	Send email when the station has reset.	<ul style="list-style-type: none"> • Checked: Send • Unchecked: Do not send 	Unchecked: Do not send
SD Card Error	Send email when a microSD access error is detected. If the error is detected continuously, mail will not be sent an additional time.	<ul style="list-style-type: none"> • Checked: Send • Unchecked: Do not send 	Unchecked: Do not send
Recording Memory Full	<p>Send email when a microSD card meets following criteria. If the error is detected continuously, mail will not be sent an additional time.</p> <ul style="list-style-type: none"> • When "Prevent Overwrite (→page 191)" is set to "Enable" <ul style="list-style-type: none"> – Recorded recordings exceeds 950 – Storage capacity remaining 5% • When "Prevent Overwrite (→page 191)" is set to "Disable" <ul style="list-style-type: none"> – Recorded recordings exceeds 999 – Storage capacity remaining 0% 	<ul style="list-style-type: none"> • Checked: Send • Unchecked: Do not send 	Unchecked: Do not send
Line Supervision (Passed)	Send email when Line Supervision is "Passed".	<ul style="list-style-type: none"> • Checked: Send • Unchecked: Do not send 	Unchecked: Do not send
Line Supervision (Failed)	Send email when Line Supervision is "Failed".	<ul style="list-style-type: none"> • Checked: Send • Unchecked: Do not send 	Unchecked: Do not send
Device Check (Passed)	Send email when Device Check is "Passed".	<ul style="list-style-type: none"> • Checked: Send • Unchecked: Do not send 	Unchecked: Do not send
Device Check (Failed)	Send email when Device Check is "Failed".	<ul style="list-style-type: none"> • Checked: Send • Unchecked: Do not send 	Unchecked: Disable
Subject	Set the Subject of email per Event Trigger. This will be used for all recipient addresses.	1 - 64 alphanumeric characters	-

Important

- "UTF-8" encoding is used for "Subject." Depending on the email client, the characters may appear incorrectly. To avoid this, set the encoding method to "UTF-8."

■ Periodic Log Transmission

Periodic Log Transmission

Settings	Destination Address		
	(1)	(2)	(3)
Periodic Log Transmission	Disable	Disable	Disable
Periodic Log Transmit Time	00 Hour 00 Minute	00 Hour 00 Minute	00 Hour 00 Minute
Periodic Log Transmit Interval	1 day	1 day	1 day
Periodic Log Transmission Subject			

Entry	Description	Settings	Default values
Periodic Log Transmission	Select Enable / Disable for send station log periodically.	<ul style="list-style-type: none"> • Enable • Disable 	Disable
Periodic Log Transmit Time	Set the time to send the periodic log.	00:00 - 23:59	00:00
Periodic Log Transmit Interval	Select the interval to send the periodic log.	1-7 days	1 day
Periodic Log Transmission Subject	Set the email subject for Periodic Log Transmission. This is used for all destination addresses.	1 - 64 alphanumeric characters	-

Important

- "UTF-8" encoding is used for "Periodic Log Transmission Subject." Depending on the email client, the characters may appear incorrectly. To avoid this, set the encoding method to "UTF-8."

■ Send Test Email

Send a test email to the address specified in ["Email Addresses \(→page 186\)"](#).

Send Test Email

Send

How to send a test email

1. Click **[Send]**.
2. The following email message will be sent to the configured address.

Example of sending an email message:

When sending a test email from this station (Station Number: 001, Station Name: Master Station 1, Location: Office).

Source	△△△△@△△△△△.com
Date and time	11/20/2018 15:22
To CC	xxxx@xxxxx.co.jp
Subject	001 Master Station 1 Email Test
Description	Test Email sent at "20181120 15:22:46." Station Number: [001] Station Name: [Intercom Station 1] Station location: [Office]

Important

- "UTF-8" encoding is used for "Subject." Depending on the email client, the characters may appear incorrectly. To avoid this, set the encoding method to "UTF-8."

Record

Configure settings related to video/audio recording. If there is no image, only audio will be recorded. When recording audio during a call, audio of this station will also be recorded.

! Important

- Video/audio cannot be recorded even if configured if no microSD card is inserted. Refer to [“About microSD card \(→page 27\)”](#) for details.

•Record

Record Event	<input type="checkbox"/> Incoming Call	<input type="checkbox"/> Communication	<input type="checkbox"/> Monitor
Recorded Device	<input checked="" type="radio"/> IX Station	<input type="radio"/> Network Camera	
Prevent Overwrite	<input type="radio"/> Enable	<input checked="" type="radio"/> Disable	
Video Recording File Length	<input type="text" value="10 min"/>		
Event Recording Timer	<input type="text" value="Disable"/>		
Manual Recording	<input checked="" type="radio"/> Enable	<input type="radio"/> Disable	
Audio Recording	<input checked="" type="radio"/> Enable	<input type="radio"/> Disable	

Entry	Description	Settings	Default values
Record Event	Configure the trigger in use to start recording video/audio automatically.	Select multiple from the following. <ul style="list-style-type: none"> • Incoming Call: Recording starts when station receives an incoming call. If a call is automatically answered, recording will start when communication starts. • Communication: Recording starts when station begins Communication. • Monitor: Recording starts when station begins Monitor. Recording is not possible during Scan Monitor. 	Not selected
Recorded Device	Set the Recorded Device when IX-MV7-* is displaying video from an IX Station and a Network Camera simultaneously.	<ul style="list-style-type: none"> • IX Station: Record IX Station video. • Network Camera: Record Network Camera video. 	IX Station
Prevent Overwrite	Set prevent overwriting the old recorded file, when the number of saved video/audio files or the microSD card capacity is full.	<ul style="list-style-type: none"> • Enable • Disable 	Disable
Video Recording File Length	Select the recording file length to split recording. Once recording has reached this time, a new recording file will be created automatically.	<ul style="list-style-type: none"> • 5 min • 10 min • 20 min • 40 min • 60 min 	10 min

Entry	Description	Settings	Default values
Event Recording Timer	Set the recording duration when the event trigger has occurred.	<ul style="list-style-type: none"> • Disable: Does not stop until the operating status ends or the record button is tapped. • 5 sec • 10 sec • 30 sec 	Disable
Manual Recording	Select Enable / Disable for manual recording.	<ul style="list-style-type: none"> • Enable • Disable 	Enable
Audio Recording	Select Enable / Disable for audio recording with video.	<ul style="list-style-type: none"> • Enable • Disable 	Enable

 **Note**

- If the ["Video Recording File Length \(→page 191\)"](#) is changed during recording video/audio, the setting will not be applied until the recording is completed.
- If "Record Event" is set to "Incoming Call" and multiple calls are received, video/audio is recorded from the first call. Other calls will begin video/audio recording when the first calls ends or when the call is answered.

Chime

Configure the chime tone to be played from this station linked with the set schedule.
Click **[Chime]**.

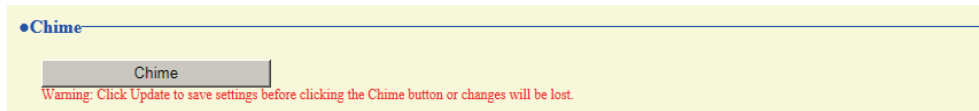

Or, click "Chime" in the Setting menu to display the Chime screen.

Weekly Schedule

Configure the start time and chime tone to play for each day of the week, from Sunday to Saturday.
50 schedules can be set for each day.

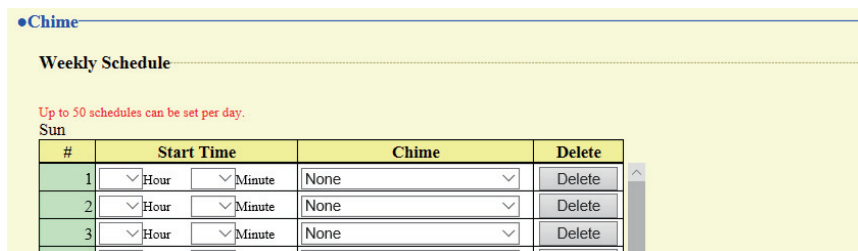

How to configure the Weekly Schedule

1. Configure "Start Time" and "Chime" for each day of the week.
2. Click **[Update]**.

Entry	Description	Settings	Default values
Start Time	Set the Time to ring Chime.	00:00 - 23:59	-
Chime	Set the sound for chime.	<ul style="list-style-type: none"> • None • Call Pattern 1 • Call Pattern 2 • Call Pattern 3 • Call Pattern 4 • Call Pattern 5 • Call Pattern 6 • Tremolo Sound • Busy Response Tone • On Hold • Operation Sound • Error • Pre Tone 1 • Pre Tone 2 • Pre Tone 3 • Communication End Pretone • Call Queue Notification • Waiting Reply Tone • Select a sound that is registered in "Custom Sound Registry" (→page 172). 	None

How to delete the Weekly Schedule

1. Click **[Delete]** on the row of the schedule to delete.
2. Click **[Update]**.

■ Daily Schedule

Configure the chime tone start time and the chime tone in units of one day.

A schedule one year from the set day can be configured. 50 schedules can be set for each day.

Daily Schedule

If the display month is changed by "<<" or ">>", unsaved settings will be lost. Click Update to save settings.

<< January, 2018 >>						
Sun	Mon	Tue	Wed	Thu	Fri	Sat
	1	2	3	4	5	6
7	8	9	10	11	12	13
14	15	16	17	18	19	20
21	22	23	24	25	26	27
28	29	30	31			

Calendar

- = Weekly
- = Daily
- = Today

Monday, January 1, 2018

0/50 Registered Schedules

Start Time	Chime	
<input type="text" value="Hour"/> <input type="text" value="Minute"/>	<input type="text" value="None"/>	<input type="button" value="Add"/>

(*) Press "Add" button to register.

Monday, January 1 Chime Schedule List (Daily, Weekly)

#	Type	Start Time	Chime	Delete
1				^
2				^

Set schedule list

How to configure Daily Schedule

1. Select a day from "Calendar."
2. Configure "Start Time" and "Chime," and click **[Add]**.
3. Click **[Update]**.

Entry	Description	Settings	Default values
Start Time	Set the Time to ring Chime.	00:00 - 23:59	-
Chime	Set the sound for chime.	<ul style="list-style-type: none"> • None • Call Pattern 1 • Call Pattern 2 • Call Pattern 3 • Call Pattern 4 • Call Pattern 5 • Call Pattern 6 • Tremolo Sound • Busy Response Tone • On Hold • Operation Sound • Error • Pre Tone 1 • Pre Tone 2 • Pre Tone 3 • Communication End Pretone • Call Queue Notification • Waiting Reply Tone • Select a sound that is registered in "Custom Sound Registry" (→page 172). 	None

How to delete Daily Schedule

1. Select the day for which to delete a schedule from "Calendar."
2. Schedules for the selected day are displayed in the "Set schedule list."
 - If a weekly schedule is configured for the selected day of the week, it will also be shown.
3. Click **[Delete]** for the schedule to delete, and click **[Update]**.
 - Refer to "[How to delete the Weekly Schedule \(→page 194\)](#)" to delete a weekly schedule.

Display Mode

Configure details for "Standard Mode" and "Receptionist Mode" configured in Display Mode Settings (administrator setting). The selected screen mode can be confirmed on the web setting screen.

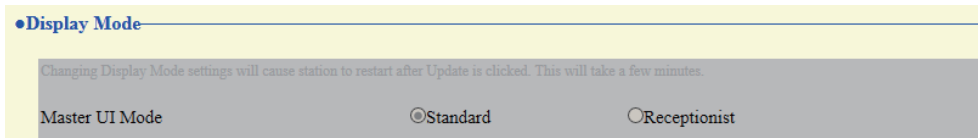

■ Standard Mode

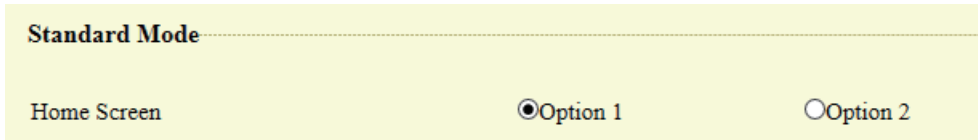

Entry	Description	Settings	Default values
Home Screen	Select the layout of top image when "Master UI Mode" is set to "Standard." Confirm main screen details in "User Interface (→page 14)" .	<ul style="list-style-type: none"> Option 1 <ul style="list-style-type: none"> Option 2 	Option 1

■ Receptionist Mode

Color Scheme

Entry	Description	Settings	Default values
Color Scheme	Select the Color Scheme of Receptionist Mode. Confirm screen images in "Color Scheme."	<ul style="list-style-type: none"> • Light • Dark 	Light

- Color Scheme

Example where "Layout 1" was set in ["Screen Layout \(→page 197\)"](#)

Light

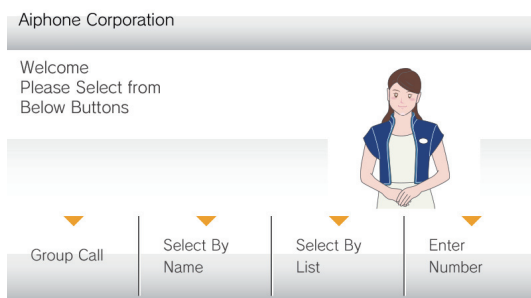

Dark

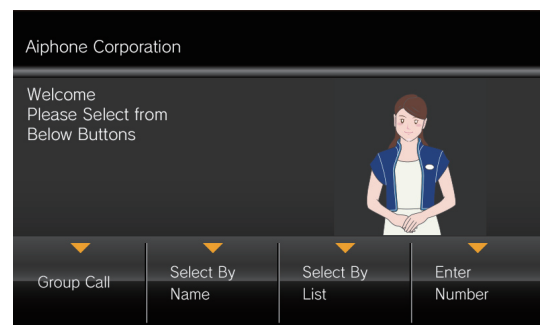

Screen Layout

Entry	Description	Settings	Default values
Screen Layout	Select the Screen Layout of top image for Receptionist Mode. Confirm screen images in "Screen Layout."	<ul style="list-style-type: none"> • Layout 1 • Layout 2 • Layout 3 	Layout 1

- Screen Layout

Example where "Light" was set in ["Color Scheme \(→page 197\)"](#)

Layout 1

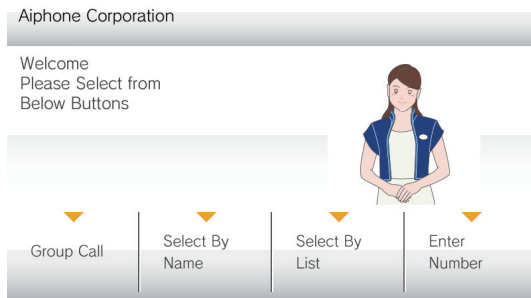

Layout 2

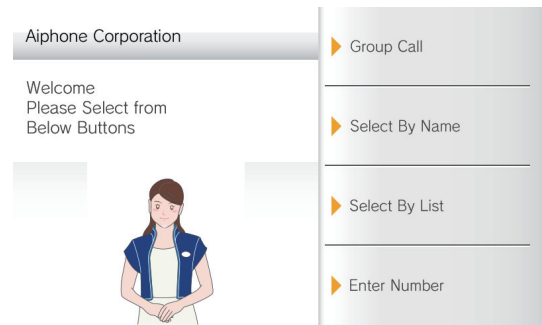

Layout 3

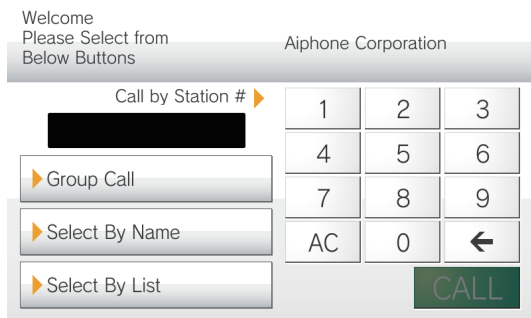

Customizing each screen layout

The layout of each screen's characters, images, and button displays can be customized.

The following spaces are customized by configuring ["Company Information \(→page 200\)"](#), ["Greeting Information \(→page 200\)"](#), ["Images \(→page 201\)"](#), and ["Button Function \(→page 202\)"](#).

Layout 1

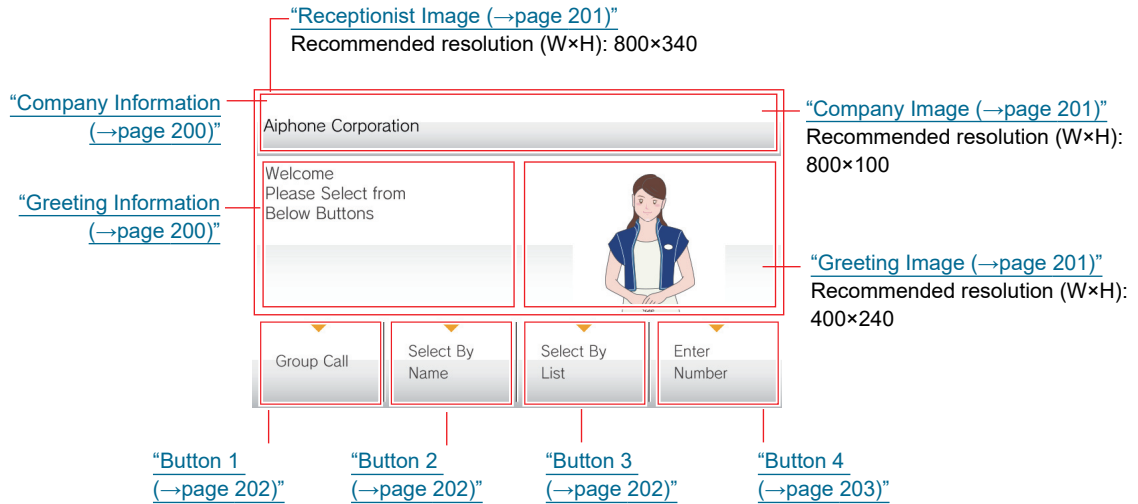

Layout 2

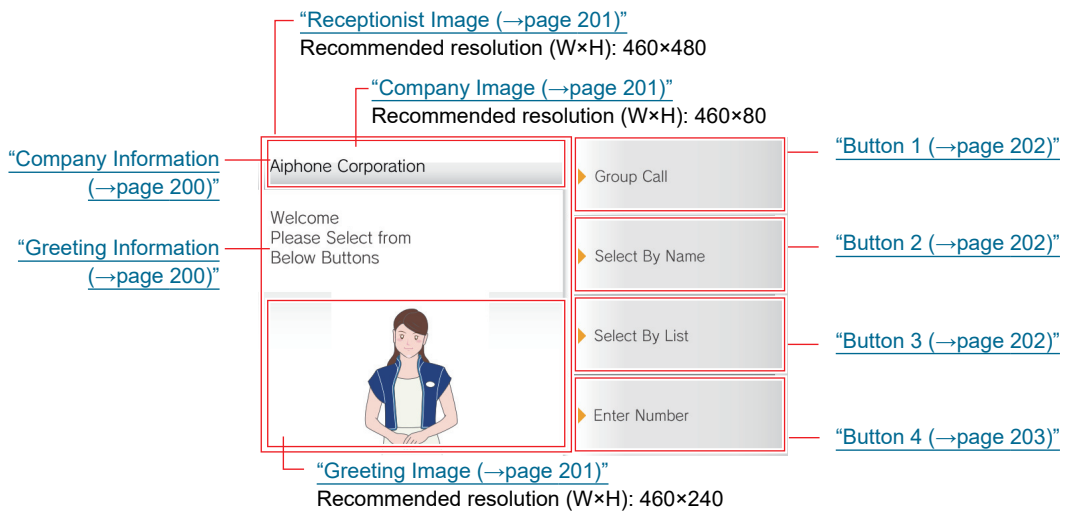

Layout 3

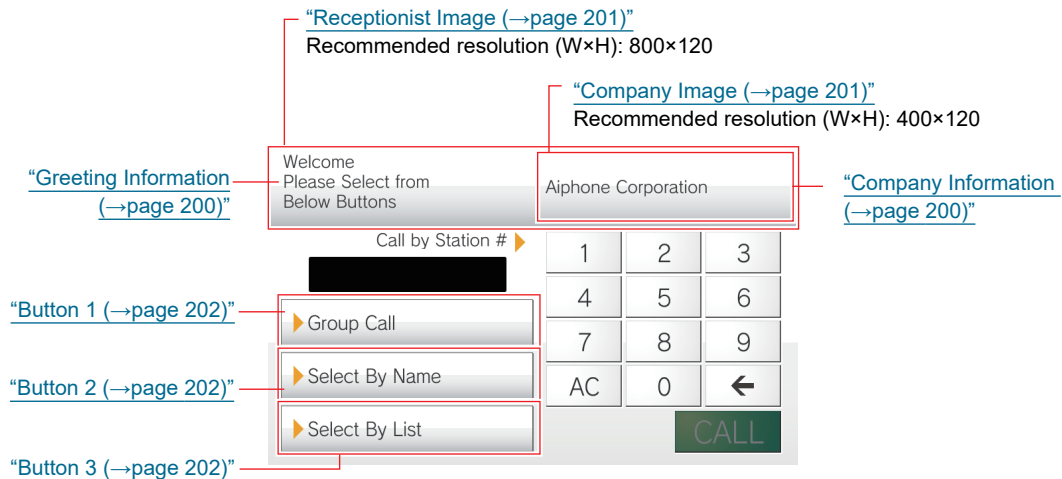

Company Information

Entry	Description	Settings	Default values
Name	Enter the Company Information.	0 - 40 alphanumeric characters	-
Text Size*1	Set the text size of Company Information.	12 - 24 pt	12 pt
Bold	Select ON / OFF for Bold text.	<ul style="list-style-type: none"> • OFF • ON 	OFF
Text Color	Set the text color of Company Information.	Option 1 <ul style="list-style-type: none"> • Black: When "Light" is selected in "Color Scheme (→page 197)" • White: When "Dark" is selected. Option 2 <ul style="list-style-type: none"> • Blue: When "Light" is selected in "Color Scheme (→page 197)" • Orange: When "Dark" is selected. 	Option 1

*1 Indicates a required field. Use the default values, unless a change is necessary.

Greeting Information

Entry	Description	Settings	Default values
Greeting	Enter Greeting text.	0 - 100 alphanumeric characters (Up to 10 line breaks can be inserted.)	-
Text Size*1	Set the text size of Greeting.	12 - 70 pt	12 pt
Bold	Select ON / OFF for Bold text.	<ul style="list-style-type: none"> • OFF • ON 	OFF

Entry	Description	Settings	Default values
Text Color	Configure the color of the characters displayed in the greeting space.	Option 1 <ul style="list-style-type: none"> • Black: When "Light" is selected in "Color Scheme (→page 197)" • White: When "Dark" is selected. Option 2 <ul style="list-style-type: none"> • Blue: When "Light" is selected in "Color Scheme (→page 197)". • Orange: When "Dark" is selected. 	Option 1

*1 Indicates a required field. Use the default values, unless a change is necessary.

Images

Entry	Description	Settings	Default values
Company Image	Update Company Image. Supported file format <ul style="list-style-type: none"> • File name: within 20 characters (excluding extension) • File format: png • Resolution Width: 400 - 800 pixels Height: 80 - 480 pixels Refer to " Customizing each screen layout (→page 199) " for recommended resolutions for each layout.	<ul style="list-style-type: none"> • Upload: Click [Browse], select a file, and then click [Upload]. • Delete: Click [Delete] to delete registered data. 	-
Greeting Image	Update Greeting Image. Supported file format <ul style="list-style-type: none"> • File name: within 20 characters (excluding extension) • File format: png • Resolution Width: 400 - 800 pixels Height: 80 - 480 pixels Refer to " Customizing each screen layout (→page 199) " for recommended resolutions for each layout.	<ul style="list-style-type: none"> • Upload: Click [Browse], select a file, and then click [Upload]. • Delete: Click [Delete] to delete registered data. 	-
Receptionist Image	Update Receptionist Image. Supported file format <ul style="list-style-type: none"> • File name: within 20 characters (excluding extension) • File format: png • Resolution Width: 400 - 800 pixels Height: 80 - 480 pixels Refer to " Customizing each screen layout (→page 199) " for recommended resolutions for each layout.	<ul style="list-style-type: none"> • Upload: Click [Browse], select a file, and then click [Upload]. • Delete: Click [Delete] to delete registered data. 	-

Button Function

Entry	Description	Settings	Default values
Button 1	Set the function of Button 1.	<ul style="list-style-type: none"> • Group Call: Call group number set by "Group Call Destination." • Select By Name: Select destination station by name. • Select By List: Select destination station by list. • Enter Number: Enter destination station number by keypad. • Hide: Button is not displayed. 	Hide
Button 2	Set the function of Button 2.	<ul style="list-style-type: none"> • Group Call: Call group number set by "Group Call Destination". • Select By Name: Select destination station by name. • Select By List: Select destination station by list. • Enter Number: Enter destination station number by keypad. • Hide: Button is not displayed. 	Hide
Button 3	Set the function of Button 3.	<ul style="list-style-type: none"> • Group Call: Call group number set by "Group Call Destination". • Select By Name: Select destination station by name. • Select By List: Select destination station by list. • Enter Number: Enter destination station number by keypad. • Hide: Button is not displayed. 	Hide

Entry	Description	Settings	Default values
Button 4	Set the function of Button 4.	<ul style="list-style-type: none"> • Group Call: Call group number set by "Group Call Destination." • Select By Name: Select destination station by name. • Select By List: Select destination station by list. • Enter Number: Enter destination station number by keypad. • Hide: Button is not displayed. 	Hide
Button Name for Group Call	Set the Button Name when Button 1 - 4 is assigned to "Group Call". If "Group Call" is set to multiple buttons, they will all share the same name.	1 - 24 alphanumeric characters	-
Button Name for Select By Name	Set the Button Name when Button 1 - 4 is assigned to "Select By Name". If "Select By Name" is set to multiple buttons, they will all share the same name.	1 - 24 alphanumeric characters	-
Button Name for Select By List	Set the Button Name when Button 1 - 4 is assigned to "Select By List". If "Select By List" is set to multiple buttons, they will all share the same name.	1 - 24 alphanumeric characters	-
Button Name for Enter Number	Set the Button Name when Button 1 - 4 is assigned to "Enter Number". If "Enter Number" is set to multiple buttons, they will all share the same name.	1 - 24 alphanumeric characters	-

Group Call Destination

Entry	Description	Settings	Default values
Group Call Destination	Set the destination group when Button 1 - 4 is assigned to "Group Call". If "Group Call" is set to multiple buttons, they will all share the same call destination group.	01-99	-

Reject Incoming Call

Entry	Description	Settings	Default values
Reject Incoming Call	Select Enable / Disable for incoming calls in Receptionist Mode.	<ul style="list-style-type: none"> • Enable • Disable 	Disable

Transfer Settings

Configure settings related to absent transfer, delay transfer, and schedule transfer.

*This is an administrator privileges setting. If "LOCK TRANSFER SETTINGS" is set to "ON," this cannot be configured under user privileges.

Absent Transfer

If an incoming call is received during absent transfer, the incoming call will be automatically transferred to a transfer destination.

! Important

- When an incoming call is received from a VoIP Phone, the call will be received without transferring even when transfer is set. To transfer the call, configure transferring on the IP-PBX.

■ Absent Transfer

Entry	Description	Settings	Default values
Absent Transfer	Select Enable / Disable for Absent Transfer. To enable "Absent Transfer", set " Transfer Destination List (→page 204) ". The TRANSFER button shown on this station's screen can also be used to change the setting.	<ul style="list-style-type: none"> • Disable: Do not set absent transfer • Enable: Set absent transfer 	Disable

■ Transfer Destination List

Entry	Description	Settings	Default values
Station Number	Configure the transfer destination station (Number) for absent transfer. Up to 10 transfer destination stations can be configured. However, if the station making the outgoing call is IX-MV, IX-DA(-*), or IX-BA, the transfer will be made only to the station entered in "No.01." IXW-MA cannot be configured as a transfer destination.	3-32 digits	-

! Important

- Do not configure multiple VoIP phones as transfer destinations. If multiple VoIP phones are configured, calls will be transferred to only one VoIP phone.

■ Re-Transfer Destination

Entry	Description	Settings	Default values
Re-Transfer Destination	Configure the transfer destination station (number) when performing absent re-transfer for a transferred call. Only a single station can be configured as the transfer destination. However, if the station making the outgoing call is IX-MV, IX-DA(-*), or IX-BA, the call will be received without re-transferring. IXW-MA cannot be configured as a transfer destination.	3-32 digits	-

Delay Transfer

An incoming call can be automatically transferred if it is received during delay transfer and not answered over a certain period of time (delay time).

! Important

- When an incoming call is received from a VoIP Phone, the call will be received without transferring even when transfer is set. To transfer the call, configure transferring on the IP-PBX.

•Delay Transfer

Delay Transfer Enable Disable

Delay Time [sec] + 1-300 sec

Transfer Destination List

#	Station Number	3-32 digits
1		
2		
3		
4		
5		
6		
7		
8		
9		
10		

Re-Transfer Destination 3-32 digits

■ Delay Transfer

Entry	Description	Settings	Default values
Delay Transfer	Select Enable / Disable for Delay Transfer. To enable "Delay Transfer", set " Transfer Destination List (→page 206) ".	<ul style="list-style-type: none"> • Disable: Delay transfer disabled • Enable: Delay transfer enabled 	Disable

■ Delay Time [sec]

Entry	Description	Settings	Default values
Delay Time [sec]*1	Set the delay time between receiving and transferring a call.	1 - 300 sec	30 sec

*1 Indicates a required field. Use the default values, unless a change is necessary.

■ Transfer Destination List

Entry	Description	Settings	Default values
Station Number	Configure the transfer destination station (Number) for absent transfer. Up to 10 transfer destination stations can be configured. However, if station making the outgoing call is IX-MV, IX-DA(-*), or IX-BA, the transfer will be made only to the station entered in "No.01." IXW-MA cannot be configured as a transfer destination.	3-32 digits	-

Important

- Do not configure multiple VoIP phones as transfer destinations. If multiple VoIP phones are configured, calls will be transferred to only one VoIP phone.

■ Re-Transfer Destination

Entry	Description	Settings	Default values
Re-Transfer Destination	Configure the transfer destination station (number) when performing delay re-transfer for a transferred call. Only a single station can be configured as the transfer destination. However, if the station making the outgoing call is IX-MV, IX-DA(-*), or IX-BA, the call will be received without re-transferring. IXW-MA cannot be configured as a transfer destination.	3-32 digits	-

Schedule Transfer

An incoming call can be automatically transferred to the transfer destination when an incoming call is received during the time configured in the weekly schedule or daily schedule.

! Important

- When an incoming call is received from a VoIP Phone, the call will be received without transferring even when transfer is set. To transfer the call, configure transferring on the IP-PBX.

Click **[Schedule Transfer]**.

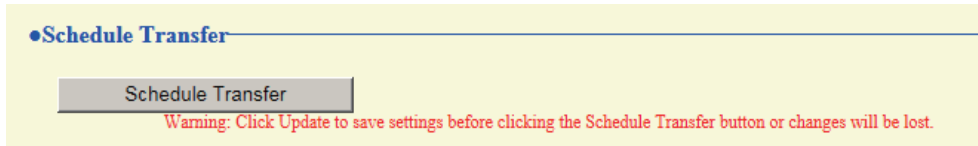

Or, click "Schedule Transfer" in the Setting menu to display the Scheduled Transfer screen.

■ Schedule Transfer

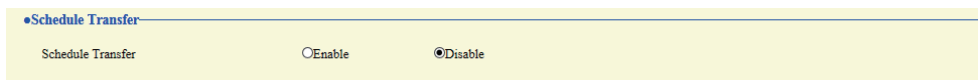

Entry	Description	Settings	Default values
Schedule Transfer	Select Enable / Disable for Schedule Transfer. To enable Schedule Transfer, set " Weekly Schedule (→page 207) " or "Daily Schedule Daily Schedule (→page 209) ".	<ul style="list-style-type: none"> • Disable: Schedule transfer disabled • Enable: Schedule transfer enabled 	Disable

■ Weekly Schedule

Configure the transfer destination and time for each day of the week from Sunday through Saturday. Up to 12 schedules can be set for each day of the week.

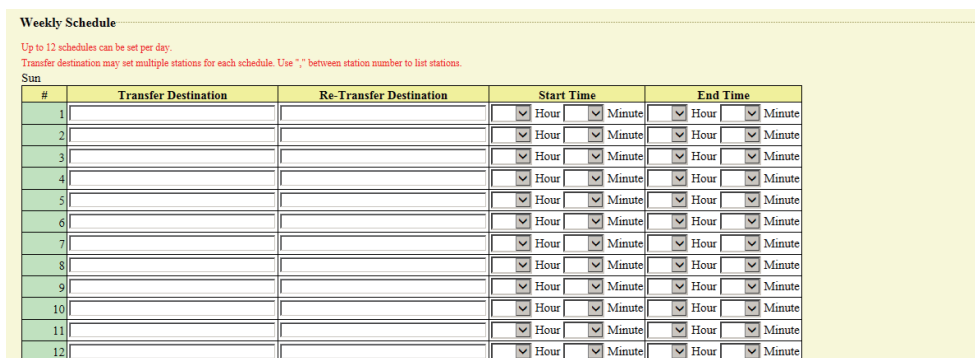

How to configure the Weekly Schedule

1. Configure the "Transfer to Station Number," "Re-Transfer Destination," "Start Time," and "End Time" for each day of the week.
2. Click **[Update]**.

Entry	Description	Settings	Default values
Transfer Destination	Configure the transfer destination for a scheduled transfer. Up to 10 transfer destination stations can be configured for each of the 12 schedules, and for each day of the week. However, if the station making the outgoing call is an IX-MV, IX-DA(-*), or IX-BA, the transfer will only be made to the station entered in "#1." IXW-MA cannot be configured as a transfer destination.	Per station: 3-32 digits To configure multiple stations, enter them separated with a comma (.). Example: 101,102,103,...	-
Re-Transfer Destination	Configure the transfer destination when performing a schedule transfer again for a transferred call. IXW-MA cannot be configured as a transfer destination. Only a single station can be set as the transfer destination. However, if the station making the outgoing call is IX-MV, IX-DA(-*), or IX-BA, the call will be received without transferring it again.	3-32 digits	-
Start Time	Set the Start Time to enable schedule transfer.	00:00 - 23:59	-
End Time	Set the End Time to disable schedule transfer. If a time earlier than "Start Time (→page 208)" is set, the end time will be the time the following day.	00:00 - 23:59	-

Important

- Do not configure multiple VoIP phones as transfer destinations. If multiple VoIP phones are configured, calls will be transferred to only one VoIP phone.

How to delete Weekly Schedule

1. Return settings to their initial values, and click **[Update]**.

■ Daily Schedule

Configure the transfer destination and time for each individual day. A schedule one year from the set day can be configured. Up to 12 schedules can be set for each day.

How to configure Daily Schedule

1. Select the day to configure a schedule from "Calendar."
2. Configure "Transfer to Station Number," "Re-Transfer Destination," "Start Time," and "End Time," and click **[Add]**.
3. Click **[Update]**.

Entry	Description	Settings	Default values
Transfer Destination	Configure the transfer destination for schedule transfer. Up to 10 transfer destination stations can be set. However, if the station making the outgoing call is IX-MV, IX-DA(-*), or IX-BA, he transfer will be made only to the station entered in "#01. IXW-MA cannot be configured as a transfer destination.	3-32 digits To configure multiple stations, enter them separated with a comma (,). Example: 101,102,103,...	-
Re-Transfer Destination	Configure the transfer destination when performing schedule transfer again for a transferred call. Only a single station can be set as the transfer destination. However, if the station making the outgoing call is IX-MV, IX-DA(-*), or IX-BA, the call will be received without transferring it again. IXW-MA cannot be configured as a transfer destination.	3-32 digits	-
Start Time	Set the Start Time to enable schedule transfer.	00:00 - 23:59	-
End Time	Set the End Time to disable schedule transfer. If this is set earlier than "Start Time (→page 209)", the end time will be for the following day.	00:00 - 23:59	-

Important

- Do not configure multiple VoIP phones as transfer destinations. If multiple VoIP phones are configured, calls will be transferred to only one VoIP phone.

How to delete Daily Schedule

1. Select the day to delete a schedule from "Calendar."
2. Schedules for the selected day are displayed in the list.
 - If a weekly schedule is configured for the selected day of the week, it will also be shown.
3. Click **[Delete]** for the schedule to delete, and click **[Update]**.
 - Refer to ["How to delete Weekly Schedule \(→page 208\)"](#) for information on deleting weekly schedules.

Station Settings

Speed Dials / Favorites

Configure the settings for Speed Dial buttons.

Select the function to assign to each Speed Dial button. Up to eight Speed Dial buttons can be configured.

*This is an administrator privileges setting. If configuring the Speed Dial buttons is restricted, this cannot be configured under user privileges.

•Speed Dials / Favorites

Speed Dial # Speed Dial 1

•Speed Dial Name 1-24 alphanumeric characters

•Function

No Function

Individual Call

Station Number 3-32 digits

Priority

Group Call

Number 01-99

Priority

Group Page

Number 01-99

Priority

All Page

Priority

Group Message Page

Number 01-99

Message

None

Priority

Play Count [time(s)]

All Message Page

Message

None

Priority

Play Count [time(s)]

Monitor

Station Number 3-32 digits

Network Camera Monitor

Network Camera

Scan Monitor

Option Relay Control

Station List

Enable	Station Number	Station Name
<input type="checkbox"/>	0001	Master Station1
<input type="checkbox"/>	0002	Master Station2
<input type="checkbox"/>	0004	Video Door Station4
<input type="checkbox"/>	0006	Door Station6
<input type="checkbox"/>	0007	Handset Sub Station7

Output Time

0 (Momentary)

200-2000 [msec]

3-600 [sec]

Output Time [msec/sec] 200-2000 msec / 200 msec step
3-600 sec / 1 sec step

TLS Enable Disable

Option Relay Control Key (*) 1-20 digits
When TLS is Enabled, the Option Relay Control Key is mandatory.

■ Speed Dial button advanced settings

How to configure speed dials

1. Select the Speed Dial to configure in "Speed Dial #."
 - The settings of the selected Speed Dial are displayed.
2. Configure each item.

3. When done, click **[Update]**.

Entry	Description	Settings	Default values
Speed Dial Name	Set the Speed Dial Name.	1 - 24 alphanumeric characters The entire name may not be shown on this station's screen, depending on the number of characters.	-
Function	Set the Speed Dial Function. Refer to " How to configure Individual Call (→page 213) " for information on how to configure detailed functions.	<ul style="list-style-type: none"> • No Function • Individual Call: Make an individual call. • Group Call: Make a group call. • Group Page: Send a group page. • All Page: Send an all page. • Group Message Page: Send a group message page. • All Message Page: Send an all page. • Monitor: Perform monitoring. • Network Camera Monitor: Perform network camera monitoring. • Scan Monitor: Perform scan monitoring. Configure scan monitoring in "Scan Monitor (→page 224)". • Option Relay Control: Control the relay output of another station. Relay output will not be controlled for IX-MV, IX-DA, or IX-BA. 	No Function

How to configure Individual Call

Configure this if "Individual Call" is set in "[Function \(→page 213\)](#)".

Entry	Description	Settings	Default values
Station Number	Set the destination station. This cannot be configured for IXW-MA.	3-32 digits	-
Priority	Set the Priority for the individual calls.	<ul style="list-style-type: none"> • Normal • Priority • Urgent 	-

How to configure Group Call

Configure if "Group Call" is set in ["Function \(→page 213\)"](#).

Entry	Description	Settings	Default values
Number	Set the destination group.	01 - 99	-
Priority	Set the priority of Group call.	<ul style="list-style-type: none"> • Normal • Priority • Urgent 	-

How to configure Group Page

Configure if "Group Page" is set in ["Function \(→page 213\)"](#).

Entry	Description	Settings	Default values
Number	Set the destination group.	01 - 99	-
Priority	Set the priority of group page.	<ul style="list-style-type: none"> • Normal • Urgent 	-

How to configure All Page

Configure this if "All Page" is set in ["Function \(→page 213\)"](#).

Entry	Description	Settings	Default values
Priority	Set the priority of all page.	<ul style="list-style-type: none"> • Normal • Urgent 	-

How to configure Group Message Page

Configure if "Group Message Page" is set in ["Function \(→page 213\)"](#).

Entry	Description	Settings	Default values
Number	Set the destination group.	01 - 99	-
Message	Select the message (audio file) to send during message paging.	<ul style="list-style-type: none"> • None • Call Pattern 1 • Call Pattern 2 • Call Pattern 3 • Call Pattern 4 • Call Pattern 5 • Call Pattern 6 • Tremolo Sound • Busy Response Tone • On Hold • Operation Sound • Error • Pre Tone 1 • Pre Tone 2 • Pre Tone 3 • Communication End Pretone • Call Queue Notification • Waiting Reply Tone • Select a sound that is registered in "Custom Sound Registry (→page 172)". 	None
Priority	Set the priority of group message page.	<ul style="list-style-type: none"> • Normal • Urgent 	-
Play Count [time(s)]	Set the message play count of group message page.	1 - 20 times	-

How to configure All Message Page

Configure this if "All Message Page" is set in ["Function \(→page 213\)"](#).

Entry	Description	Settings	Default values
Message	Select the message (audio file) to send during all message paging.	<ul style="list-style-type: none"> • None • Call Pattern 1 • Call Pattern 2 • Call Pattern 3 • Call Pattern 4 • Call Pattern 5 • Call Pattern 6 • Tremolo Sound • Busy Response Tone • On Hold • Operation Sound • Error • Pre Tone 1 • Pre Tone 2 • Pre Tone 3 • Communication End Pretone • Call Queue Notification • Waiting Reply Tone • Select a sound that is registered in "Custom Sound Registry (→page 172)". 	None
Priority	Set the priority of all message page.	<ul style="list-style-type: none"> • Normal • Urgent 	-
Play Count [time(s)]	Set the message play count of all message page.	1 - 20 times	-

How to configure Monitor

Configure if "Monitor" is set in ["Function \(→page 213\)"](#).

Entry	Description	Settings	Default values
Station Number	Set the destination station. This cannot be configured for IX-MV7-*, IX-MV, IXW-MA, or a VoIP Phone.	3-32 digits	-

How to configure Network Camera Monitor

Configure if "Network Camera Monitor" is set in ["Function \(→page 213\)"](#).

Entry	Description	Settings	Default values
Network Camera	Set the destination Network Camera.	Select from the registered network cameras.	-

How to configure Option Relay Control

Configure if "Option Relay Control" is set in ["Function \(→page 213\)"](#).

Note

- When controlling relay output for multiple stations, processing may take some time and control may be delayed.

Entry	Description	Settings	Default values
Station List	Configure a station to control relay output. This cannot be configured for IX-MV, IX-DA(-*), or IX-BA, or a VoIP Phone. Multiple (unlimited) stations can be configured.	Check "Enable" for the station for which to perform contact output (multiple selections allowed).	-
Output Time	Set the Output Time within the range selected in "Output Time Range".	<ul style="list-style-type: none"> • 0 (Momentary): Pressing the Speed Dial button to start continuous relay output. Pressing the Speed Dial button again will stop relay output. • 200 - 2000 [msec]: Select this when configuring a value from 200 to 2000 msec (by 200 msec). Enter the time in "Output Time [msec / sec]*1." • 3 - 600 [sec]: Select this when configuring a value from 3 to 600 sec (by 1 sec). Enter the time in "Output Time [msec / sec]*1." 	0 (Momentary)
TLS	Select Enable / Disable for TLS. When "Enable" is selected, set "Option Relay Control Key".	<ul style="list-style-type: none"> • Enable • Disable 	Disable
Option Relay Control Key	Set the Option Relay Control Key. When matched with the Option Relay Control Authentication Key in "Option Relay Control Authentication Key".	1 - 20 digits	-

*1 Indicates a required field. Use the default values, unless a change is necessary.

Important

- If "TLS" is set to "Enable," this may take some time if there are multiple stations to control.

Note

- The "Option Relay Control Key" is displayed as "●●●●●" in the Settings screen.

Privacy

Configure to prevent the other station from hearing/viewing audio or camera images, when [“Auto Answer \(→page 177\)”](#) is set to "ON."

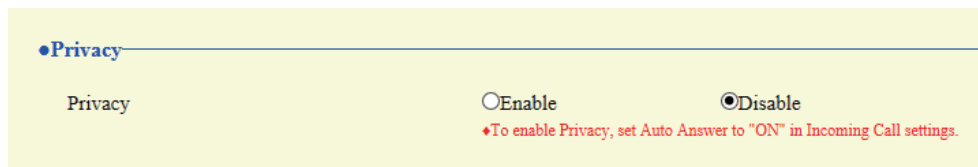

■ Privacy setting

Entry	Description	Settings	Default values
Privacy	Select Enable / Disable for Privacy function. The setting can also be changed on the station.	<ul style="list-style-type: none"> • Enable • Disable 	Disable

Volume / Tone

■ Volume

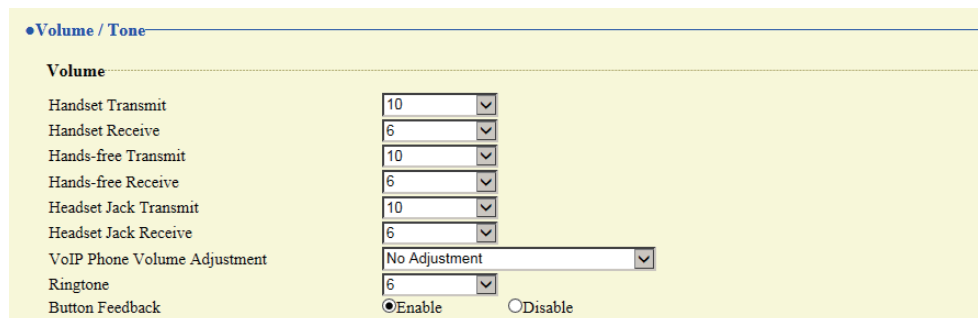

Entry	Description	Settings	Default values
Handset Transmit	Set the transmit volume using handset while communicating and paging.	1 - 10	10
Handset Receive	Set the receive volume using handset while communicating. Also sets ringback tone volume.	1 - 10	6
Hands-free Transmit	Set the hands-free transmit volume while communicating and paging.	1 - 10	10
Hands-free Receive	Set the hands-free receive volume while communicating and paging. Also sets ringback tone volume.	1 - 10	6
Headset Jack Transmit	Set the transmit volume using headset jack.	1 - 10	10
Headset Jack Receive	Set the receive volume using headset jack.	1 - 10	6
VoIP Phone Volume Adjustment	Select the volume adjustment between VoIP Phone and IX stations.	<ul style="list-style-type: none"> • -12dB from VoIP, +12dB to VoIP • -6dB from VoIP, +6dB to VoIP • No Adjustment • +6dB from VoIP, -6dB to VoIP • +12dB from VoIP, -12dB to VoIP 	No Adjustment

Entry	Description	Settings	Default values
Ringtone	Select the volume for Ringtone and Paging Pretone.	0 - 10	6
Button Feedback	Select Enable / Disable for Button Feedback tone.	<ul style="list-style-type: none"> • Enable • Disable 	Enable

■ Tone

Tone

Communication Timeout Notification	Error
Communication End Pretone	Communication End Pretone
Call Queue Notification	Call Queue Notification
Paging Pretone	Pre Tone 2
Auto Answer Tone	Pre Tone 1
On Hold	On Hold
Key Received	None

! Important

- Configure the paging pretone with a longer duration than the paging pretone of the station receiving the page. Configuring a shorter tone might prevent audio from playing on the other station when paging starts. Configure the same tone as that of other IX-MV7-* and IX-MV stations in the system.

Entry	Description	Settings	Default values
Communication Timeout Notification	Select the tone to be played when an outgoing call times out.	<ul style="list-style-type: none"> • None • Call Pattern 1 • Call Pattern 2 • Call Pattern 3 • Call Pattern 4 • Call Pattern 5 • Call Pattern 6 • Tremolo Sound • Busy Response Tone • On Hold • Operation Sound • Error • Pre Tone 1 • Pre Tone 2 • Pre Tone 3 • Communication End Pretone • Call Queue Notification • Waiting Reply Tone • Select a sound that is registered in "Custom Sound Registry" (→page 172). 	Error

Entry	Description	Settings	Default values
Communication End Pretone	Select the tone to be played 10 sec before communication, paging or monitoring ends.	<ul style="list-style-type: none"> • None • Call Pattern 1 • Call Pattern 2 • Call Pattern 3 • Call Pattern 4 • Call Pattern 5 • Call Pattern 6 • Tremolo Sound • Busy Response Tone • On Hold • Operation Sound • Error • Pre Tone 1 • Pre Tone 2 • Pre Tone 3 • Communication End Pretone • Call Queue Notification • Waiting Reply Tone • Select a sound that is registered in "Custom Sound Registry" (→page 172). 	Communication End Pretone
Call Queue Notification	Select the tone to be played when receiving a call while communicating.	<ul style="list-style-type: none"> • None • Call Pattern 1 • Call Pattern 2 • Call Pattern 3 • Call Pattern 4 • Call Pattern 5 • Call Pattern 6 • Tremolo Sound • Busy Response Tone • On Hold • Operation Sound • Error • Pre Tone 1 • Pre Tone 2 • Pre Tone 3 • Communication End Pretone • Call Queue Notification • Waiting Reply Tone • Select a sound that is registered in "Custom Sound Registry" (→page 172). 	Call Queue Notification

Entry	Description	Settings	Default values
Paging Pretone	Select the sound to be played when placing or receiving a page.	<ul style="list-style-type: none"> • None • Call Pattern 1 • Call Pattern 2 • Call Pattern 3 • Call Pattern 4 • Call Pattern 5 • Call Pattern 6 • Tremolo Sound • Busy Response Tone • On Hold • Operation Sound • Error • Pre Tone 1 • Pre Tone 2 • Pre Tone 3 • Communication End Pretone • Call Queue Notification • Waiting Reply Tone • Select a sound that is registered in "Custom Sound Registry" (→page 172). 	Pre Tone 2
Auto Answer Tone	Select the tone to be played. <ul style="list-style-type: none"> • Ringtone when receiving an individual call. "Auto Answer (→page 177)" must be set to "ON." • Ringback tone when placing an individual call. "Auto Answer (→page 177)" must be set to "ON" at the destination station. 	<ul style="list-style-type: none"> • None • Call Pattern 1 • Call Pattern 2 • Call Pattern 3 • Call Pattern 4 • Call Pattern 5 • Call Pattern 6 • Tremolo Sound • Busy Response Tone • On Hold • Operation Sound • Error • Pre Tone 1 • Pre Tone 2 • Pre Tone 3 • Communication End Pretone • Call Queue Notification • Waiting Reply Tone • Select a sound that is registered in "Custom Sound Registry" (→page 172). 	Pre Tone 1

Entry	Description	Settings	Default values
On Hold	Select the tone to be played while On-Hold.	<ul style="list-style-type: none"> • None • Call Pattern 1 • Call Pattern 2 • Call Pattern 3 • Call Pattern 4 • Call Pattern 5 • Call Pattern 6 • Tremolo Sound • Busy Response Tone • On Hold • Operation Sound • Error • Pre Tone 1 • Pre Tone 2 • Pre Tone 3 • Communication End Pretone • Call Queue Notification • Waiting Reply Tone • Select a sound that is registered in "Custom Sound Registry" (→page 172). 	On Hold
Key Received	Configure the tone to send to the other station when the door release key entered using a keypad on the other station (station performing a door release operation) matches the authentication key of this station (station connected to the electrical lock). The tone will be heard on the other station.	<ul style="list-style-type: none"> • None • Call Pattern 1 • Call Pattern 2 • Call Pattern 3 • Call Pattern 4 • Call Pattern 5 • Call Pattern 6 • Tremolo Sound • Busy Response Tone • On Hold • Operation Sound • Error • Pre Tone 1 • Pre Tone 2 • Pre Tone 3 • Communication End Pretone • Call Queue Notification • Waiting Reply Tone • Select a sound that is registered in "Custom Sound Registry" (→page 172). 	None

Communication

•Communication

Talk Timeout [sec] * sec Infinite or 30-600 sec / 1 sec step

Force Touch-to-Talk Enable Disable

Entry	Description	Settings	Default values
Talk Timeout [sec] ^{*1}	Set the communication timer when placing a call or answering a page. Communication timer when receiving a call is set at the destination station.	<ul style="list-style-type: none"> Infinite: No timeout. 30-600 sec: Configure between 30 to 600 sec (by 1 sec). 	60sec
Force Touch-to-Talk	Select Enable / Disable for Force Touch-to-Talk when starting communication in hands-free mode.	<ul style="list-style-type: none"> Enable Disable 	Disable

*1 Indicates a required field. Use the default values, unless a change is necessary.

Important

- When on a call with a VoIP Phone, this will be the call duration configured on the VoIP Phone.

Monitor

! Important

- Monitoring cannot be performed for IX-MV7-*, IX-MV, or VoIP phones.

Monitor

Monitor Timeout [sec] sec Infinite or 10-600 sec / 1 sec step

Scan Monitor

#	Station / Network Camera List
1	<input type="text"/>
2	<input type="text"/>
3	<input type="text"/>
4	<input type="text"/>
5	<input type="text"/>
6	<input type="text"/>
7	<input type="text"/>
8	<input type="text"/>
9	<input type="text"/>
10	<input type="text"/>
11	<input type="text"/>
12	<input type="text"/>
13	<input type="text"/>
14	<input type="text"/>
15	<input type="text"/>
16	<input type="text"/>
17	<input type="text"/>
18	<input type="text"/>
19	<input type="text"/>
20	<input type="text"/>
21	<input type="text"/>

Dwell Time sec

■ Monitor Timeout [sec]

Entry	Description	Settings	Default values
Monitor Timeout [sec] ^{*1}	Set the monitoring timer by station. Scan Monitor must be end manually.	<ul style="list-style-type: none"> • Infinite • 10-600 seconds: Configure between 10 and 600 sec (by 1 sec). 	60sec

*1 Indicates a required field. Use the default values, unless a change is necessary.

■ Scan Monitor

Perform monitoring by automatically switching between several stations and network cameras at set intervals.

Entry	Description	Settings	Default values
Station / Network Camera List	Configure the station and network camera to perform scan monitoring. Scan monitoring will be performed in order of series number. A combined total of 1000 stations and network cameras can be configured. Multiple network cameras can also be set to a single station.	Select from stations and network cameras registered in "Address Book." This cannot be selected for IX-MV7-*, IXW-MA, IX-MV, or a VoIP phone.	-

■ Dwell Time

Entry	Description	Settings	Default values
Dwell Time	Set the dwell time to change destination for scan monitor.	<ul style="list-style-type: none"> • 5 sec • 10 sec • 30 sec 	5 sec

Master Station Display

● **Master Station Display**

Brightness

Primary Video Source IX Station Network Camera

Aspect Ratio 4:3 16:9

Standby LED State ON OFF

Keypad ON OFF

Entry	Description	Settings	Default values
Brightness	Set the Brightness of Master station display.	1 - 10	6
Primary Video Source	Select the primary video source when showing 2 video stream simultaneously.	<ul style="list-style-type: none"> • IX Station • Network Camera 	IX Station
Aspect Ratio	Select the video aspect for primary video source.	<ul style="list-style-type: none"> • 16:9 • 4:3 	16:9
Standby LED State	Select ON / OFF for standby status LED.	<ul style="list-style-type: none"> • ON • OFF 	ON
Keypad	Select ON / OFF for whether to display the keypad used for door release and playing location messages.	<ul style="list-style-type: none"> • ON • OFF 	ON

Maintenance

Initialization

The setting values for everything except for [“Settings on the station \(→page 91\)”](#) - [“Language \(→page 102\)”](#) and [“Settings using a PC \(→page 93\)”](#) administrator privilege settings will return to their initial values. Settings restricted with administrator privileges will not return to their initial values.

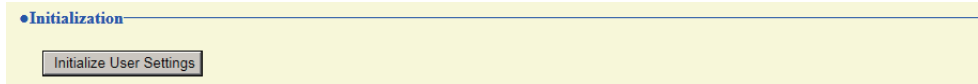

How to initialize

1. Click **[Initialize User Settings]**.
2. Click **[OK]**.
 - Click **[Cancel]** to cancel the initialization.

Important

- If the initialization process fails, a message (**[Error: Station initialization failed.]**) will be displayed. Re-initialize if this happens.

Specifications

Power	PoE (IEEE802.3af Class 0 standard)
Current Consumption	Standby: 66 mA; Maximum: 155 mA
Communication	Hands-free/touch-to-talk (concurrent communication for calls between handsets only)
Display	7" TFT LCD display WVGA 800×480 (approx. 1.15 million pixels)
Camera	1/4-type CMOS VGA 640×480 (approx. 300,000 pixels)
LAN	Ethernet (10BASE-T, 100BASE-TX), Auto MDI/MDI-X-compatible
Audio codec	G.711 (u-law, A-law), G.722
Video codec	H.264/AVC, Motion-JPEG
Protocol	IPv4, IPv6, TCP, UDP, SIP, HTTP, HTTPS, RTSP, RTP, RTCP, IGMP, MLD, SMTP, SFTP, DHCP, NTP, DNS
Encryption system	TLS1.0, TLS1.1, TLS1.2
Packet transmission system	Unicast and multicast
Number of stations in address book	500 stations
Operating temperature	0 °C to +40 °C (+32 °F to +104 °F)
Mounting	Table/wall-mounted
Materials	Fire-retardant resin
Color	IX-MV7-HW, IX-MV7-W: White IX-MV7-HB, IX-MV7-B: Black
Dimensions	IX-MV7-HB and IX-MV7-HW: 280 mm (11") [W] × 204 mm (8-1/16") [H] × 55.5 mm (2-3/16") [D] IX-MV7-B and IX-MV7-W: 220 mm (8-11/16") [W] × 172 mm (6-3/4") [H] × 31.5 mm (1-1/4") [D] (excluding projection)
Weight	IX-MV7-HB and IX-MV7-HW: Approx. 1.0 kg (2.2 lbs) (approx. 1.3 kg (2.9 lbs) when used on table) IX-MV7-B and IX-MV7-W: Approx. 680 g (1.5 lbs) (approx. 870 g (1.97 lbs) when used on table)

Maintenance

- Clean the station gently with a soft, dry cloth. For difficult stains, dip a soft cloth in neutral detergent diluted with water, wring it out well, and then clean unit.
- Use a soft, dry cloth (for use in wiping mirrors) when wiping the display.

Important

- Do not use chemicals such as benzene or paint thinner. You may damage the surface of the station, or cause discoloration.

Notice regarding the software

Use of the software installed on this product has received direct or indirect authorization from third parties.

(1) Apache License 2.0

This software includes Google Protocol Buffers.

You may obtain a copy of the License at "<http://www.apache.org/licenses/LICENSE-2.0>".

Please be noted that a portion of this software is made by changing or modifying original source files.

(2) bzip2 and libbzip2 License

This file is a part of bzip2 and/or libbzip2, a program and library for lossless, block-sorting data compression.

Copyright (C) 1996-2002 Julian R Seward. All rights reserved.

Redistribution and use in source and binary forms, with or without modification, are permitted provided that the following conditions are met:

1. Redistributions of source code must retain the above copyright notice, this list of conditions and the following disclaimer.
2. The origin of this software must not be misrepresented; you must not claim that you wrote the original software. If you use this software in a product, an acknowledgment in the product documentation would be appreciated but is not required.
3. Altered source versions must be plainly marked as such, and must not be misrepresented as being the original software.
4. The name of the author may not be used to endorse or promote products derived from this software without specific prior written permission.

THIS SOFTWARE IS PROVIDED BY THE AUTHOR "AS IS" AND ANY EXPRESS OR IMPLIED WARRANTIES, INCLUDING, BUT NOT LIMITED TO, THE IMPLIED WARRANTIES OF MERCHANTABILITY AND FITNESS FOR A PARTICULAR PURPOSE ARE DISCLAIMED.

IN NO EVENT SHALL THE AUTHOR BE LIABLE FOR ANY DIRECT, INDIRECT, INCIDENTAL, SPECIAL, EXEMPLARY, OR CONSEQUENTIAL DAMAGES (INCLUDING, BUT NOT LIMITED TO, PROCUREMENT OF SUBSTITUTE GOODS OR SERVICES; LOSS OF USE, DATA, OR PROFITS; OR BUSINESS INTERRUPTION) HOWEVER CAUSED AND ON ANY THEORY OF LIABILITY, WHETHER IN CONTRACT, STRICT LIABILITY, OR TORT (INCLUDING NEGLIGENCE OR OTHERWISE) ARISING IN ANY WAY OUT OF THE USE OF THIS SOFTWARE, EVEN IF ADVISED OF THE POSSIBILITY OF SUCH DAMAGE.

(3) CMU License

Copyright 1989, 1991, 1992 by Carnegie Mellon University

Derivative Work - 1996, 1998-2000 Copyright 1996, 1998-2000 The Regents of the University of California

All Rights Reserved

Permission to use, copy, modify and distribute this software and its documentation for any purpose and without fee is hereby granted, provided that the above copyright notice appears in all copies and that both that copyright notice and this permission notice appear in supporting documentation, and that the name of CMU and The Regents of the University of California not be used in advertising or publicity pertaining to distribution of the software without specific written permission.

CMU AND THE REGENTS OF THE UNIVERSITY OF CALIFORNIA DISCLAIM ALL WARRANTIES WITH REGARD TO THIS SOFTWARE, INCLUDING ALL IMPLIED WARRANTIES OF MERCHANTABILITY AND FITNESS.

IN NO EVENT SHALL CMU OR THE REGENTS OF THE UNIVERSITY OF CALIFORNIA BE LIABLE FOR ANY SPECIAL, INDIRECT OR CONSEQUENTIAL DAMAGES OR ANY DAMAGES WHATSOEVER RESULTING FROM THE LOSS OF USE, DATA OR PROFITS, WHETHER IN AN ACTION OF CONTRACT, NEGLIGENCE OR OTHER TORTIOUS ACTION, ARISING OUT OF OR IN CONNECTION WITH THE USE OR PERFORMANCE OF THIS SOFTWARE.

(4) GPL/LGPL

This product includes software components subject to the GPL/LGPL.

Details can be found at the following links.

<http://www.gnu.org/licenses/gpl.html>

<http://www.gnu.org/licenses/lgpl.html>

Customers can obtain, modify, and re-distribute the source code of the software components according to the GPL/LGPL.

Please see the website below for information on how to obtain related source code and confirm GPL/LGPL.

<http://www.aiphone.co.jp/data/software/source/gpl/download/ix/>

* Be sure to read the following before downloading.

<<Please confirm>>

- According to GPL/LGPL, the source code of the software components is not guaranteed, including warranty on “merchantability” or “suitability for a particular purpose.”
- The source code of the software components is provided "as is" and based on the GPL/LGPL.
- Please note that we cannot answer questions regarding the content of the source code of the software components.

(5) ISC License

Copyright (c) 2004-2011 by Internet Systems Consortium, Inc. ("ISC")

Copyright (c) 1995-2003 by Internet Software Consortium Permission to use, copy, modify, and/or distribute this software for any purpose with or without fee is hereby granted, provided that the above copyright notice and this permission notice appear in all copies.

THE SOFTWARE IS PROVIDED "AS IS" AND ISC DISCLAIMS ALL WARRANTIES WITH REGARD TO THIS SOFTWARE INCLUDING ALL IMPLIED WARRANTIES OF MERCHANTABILITY AND FITNESS.

IN NO EVENT SHALL ISC BE LIABLE FOR ANY SPECIAL, DIRECT, INDIRECT, OR CONSEQUENTIAL DAMAGES OR ANY DAMAGES WHATSOEVER RESULTING FROM LOSS OF USE, DATA OR PROFITS, WHETHER IN AN ACTION OF CONTRACT, NEGLIGENCE OR OTHER TORTIOUS ACTION, ARISING OUT OF OR IN CONNECTION WITH THE USE OR PERFORMANCE OF THIS SOFTWARE.

(6) MIT License

Copyright (c) 2018 Aiphone co.,Ltd.

Released under the MIT license.

Permission is hereby granted, free of charge, to any person obtaining a copy of this software and associated documentation files (the "Software"), to deal in the Software without restriction, including without limitation the rights to use, copy, modify, merge, publish, distribute, sublicense, and/or sell copies of the Software, and to permit persons to whom the Software is furnished to do so, subject to the following conditions:

The above copyright notice and this permission notice shall be included in all copies or substantial portions of the Software.

THE SOFTWARE IS PROVIDED "AS IS", WITHOUT WARRANTY OF ANY KIND, EXPRESS OR IMPLIED, INCLUDING BUT NOT LIMITED TO THE WARRANTIES OF MERCHANTABILITY, FITNESS FOR A PARTICULAR PURPOSE AND NONINFRINGEMENT.

IN NO EVENT SHALL THE AUTHORS OR COPYRIGHT HOLDERS BE LIABLE FOR ANY CLAIM, DAMAGES OR OTHER LIABILITY, WHETHER IN AN ACTION OF CONTRACT, TORT OR OTHERWISE, ARISING FROM, OUT OF OR IN CONNECTION WITH THE SOFTWARE OR THE USE OR OTHER DEALINGS IN THE SOFTWARE.

(7) NTP License

Copyright (c) University of Delaware 1992-2011

Permission to use, copy, modify, and distribute this software and its documentation for any purpose with or without fee is hereby granted, provided that the above copyright notice appears in all copies and that both the copyright notice and this permission notice appear in supporting documentation, and that the name University of Delaware not be used in advertising or publicity pertaining to distribution of the software without specific, written prior permission.

The University of Delaware makes no representations about the suitability this software for any purpose.

It is provided "as is" without express or implied warranty.

(8) OpenSSL License

Copyright (c) 1998-2011 The OpenSSL Project. All rights reserved.

Redistribution and use in source and binary forms, with or without modification, are permitted provided that the following conditions are met:

- (a) Redistributions of source code must retain the above copyright notice, this list of conditions and the following disclaimer.
- (b) Redistributions in binary form must reproduce the above copyright notice, this list of conditions and the following disclaimer in the documentation and/or other materials provided with the distribution.
- (c) All advertising materials mentioning features or use of this software must display the following acknowledgment:
"This product includes software developed by the OpenSSL Project for use in the OpenSSL Toolkit. (<http://www.openssl.org/>)"
- (d) The names "OpenSSL Toolkit" and "OpenSSL Project" must not be used to endorse or promote products derived from this software without prior written permission. For written permission, please contact openssl-core@openssl.org.
- (e) Products derived from this software may not be called "OpenSSL" nor may "OpenSSL" appear in their names without prior written permission of the OpenSSL Project.
- (f) Redistributions of any form whatsoever must retain the following acknowledgment:
"This product includes software developed by the OpenSSL Project for use in the OpenSSL Toolkit (<http://www.openssl.org/>)"

THIS SOFTWARE IS PROVIDED BY THE OpenSSL PROJECT "AS IS" AND ANY EXPRESSED OR IMPLIED WARRANTIES, INCLUDING, BUT NOT LIMITED TO, THE IMPLIED WARRANTIES OF MERCHANTABILITY AND FITNESS FOR A PARTICULAR PURPOSE ARE DISCLAIMED.

IN NO EVENT SHALL THE OpenSSL PROJECT OR ITS CONTRIBUTORS BE LIABLE FOR ANY DIRECT, INDIRECT, INCIDENTAL, SPECIAL, EXEMPLARY, OR CONSEQUENTIAL DAMAGES (INCLUDING, BUT NOT LIMITED TO, PROCUREMENT OF SUBSTITUTE GOODS OR SERVICES; LOSS OF USE, DATA, OR PROFITS; OR BUSINESS INTERRUPTION) HOWEVER CAUSED AND ON ANY THEORY OF LIABILITY, WHETHER IN CONTRACT, STRICT LIABILITY, OR TORT (INCLUDING NEGLIGENCE OR OTHERWISE) ARISING IN ANY WAY OUT OF THE USE OF THIS SOFTWARE, EVEN IF ADVISED OF THE POSSIBILITY OF SUCH DAMAGE.

(9) Original SSLeay License

Redistribution and use in source and binary forms, with or without modification, are permitted provided that the following conditions are met:

- (a) Redistributions of source code must retain the copyright notice, this list of conditions and the following disclaimer.
- (b) Redistributions in binary form must reproduce the above copyright notice, this list of conditions and the following disclaimer in the documentation and/or other materials provided with the distribution.
- (c) All advertising materials mentioning features or use of this software must display the following acknowledgment:
"This product includes cryptographic software written by Eric Young (eay@cryptsoft.com)" The word 'cryptographic' can be left out if the routines from the library being used are not cryptographic related :-).
- (d) If you include any Windows specific code (or a derivative thereof) from the apps directory (application code) you must include an acknowledgment:
"This product includes software written by Tim Hudson (tjh@cryptsoft.com)"

THIS SOFTWARE IS PROVIDED BY ERIC YOUNG "AS IS" AND ANY EXPRESS OR IMPLIED WARRANTIES, INCLUDING, BUT NOT LIMITED TO, THE IMPLIED WARRANTIES OF MERCHANTABILITY AND FITNESS FOR A PARTICULAR PURPOSE ARE DISCLAIMED.

IN NO EVENT SHALL THE AUTHOR OR CONTRIBUTORS BE LIABLE FOR ANY DIRECT, INDIRECT, INCIDENTAL, SPECIAL, EXEMPLARY, OR CONSEQUENTIAL DAMAGES (INCLUDING, BUT NOT LIMITED TO, PROCUREMENT OF SUBSTITUTE GOODS OR SERVICES; LOSS OF USE, DATA, OR PROFITS; OR BUSINESS INTERRUPTION) HOWEVER CAUSED AND ON ANY THEORY OF LIABILITY, WHETHER IN CONTRACT, STRICT LIABILITY, OR TORT (INCLUDING NEGLIGENCE OR OTHERWISE) ARISING IN ANY WAY OUT OF THE USE OF THIS SOFTWARE, EVEN IF ADVISED OF THE POSSIBILITY OF SUCH DAMAGE.

(10) RSA Message-Digest License

Copyright (C) 1990, RSA Data Security, Inc. All rights reserved.

License to copy and use this software is granted provided that it is identified as the "RSA Data Security, Inc. MD5 Message-Digest Algorithm" in all material mentioning or referencing this software or this function.

License is also granted to make and use derivative works provided that such works are identified as "derived from the RSA Data Security, Inc. MD5 Message-Digest Algorithm" in all material mentioning or referencing the derived work.

RSA Data Security, Inc. makes no representations concerning either the merchantability of this software or the suitability of this software for any particular purpose.

It is provided "as is" without express or implied warranty of any kind.

These notices must be retained in any copies of any part of this documentation and/or software.

Please be noted that this software is derived from the RSA Data Security, Inc. MD5 Message-Digest Algorithm.

(11) Sendmail License

Copyright (c) 1988, 1993 The Regents of the University of California. All rights reserved.

(12) zlib License

(C) 1995-2010 Jean-loup Gailly and Mark Adler

(13) This software is based in part on the work of the Independent JPEG Group.

(14) This software is based in part on the work of the FreeType team.

See the following website for source code including changes for software that has been authorized under the above licenses.

<http://www.aiphone.co.jp/data/software/source/gpl/download/ix/>

* Be sure to read the following before downloading.

<<Please confirm>>

- Please note that we cannot answer questions regarding the content of the source code of the software components.

REGULATIONS

FCC

This device complies with part 15 of the FCC Rules. Operation is subject to the following two conditions: (1) This device may not cause harmful interference, and (2) this device must accept any interference received, including interference that may cause undesired operation.

NOTE: This equipment has been tested and found to comply with the limits for a Class B digital device, pursuant to part 15 of the FCC Rules. These limits are designed to provide reasonable protection against harmful interference in a residential installation.

This equipment generates, uses and can radiate radio frequency energy and, if not installed and used in accordance with the instructions, may cause harmful interference to radio communications. However, there is no guarantee that interference will not occur in a particular installation. If this equipment does cause harmful interference to radio or television reception, which can be determined by turning the equipment off and on, the user is encouraged to try to correct the interference by one or more of the following measures:

- Reorient or relocate the receiving antenna.
- Increase the separation between the equipment and receiver.
- Connect the equipment into an outlet on a circuit different from that to which the receiver is connected.
- Consult the dealer or an experienced radio/TV technician for help.

INDUSTRY CANADA
CAN ICES-3 (B)/NMB-3(B)

WEEE

The object area of  is the EU.

WARRANTY

Aiphone warrants its products to be free from defects of material and workmanship under normal use and service for a period of 2 years after delivery to the ultimate user and will repair free of charge or replace at no charge, should it become defective upon which examination shall disclose to be defective and under warranty. Aiphone reserves unto itself the sole right to make the final decision whether there is a defect in materials and/or workmanship; and whether or not the product is within the warranty. This warranty shall not apply to any Aiphone product which has been subject to misuse, neglect, accident, power surge, or to use in violation of instructions furnished, nor extended to units which have been repaired or altered outside of the factory. This warranty does not cover batteries or damage caused by batteries used in connection with the unit. This warranty covers bench repairs only, and any repairs must be made at the shop or place designated in writing by Aiphone. This warranty is limited to the standard specifications listed in the operation manual. This warranty does not cover any supplementary function of a third party product that is added by users or suppliers. Please note that any damage or other issues caused by failure of function or interconnection with Aiphone products is also not covered by this warranty. Aiphone will not be responsible for any costs incurred involving on site service calls. Aiphone will not provide compensation for any loss or damage incurred by the breakdown or malfunction of its products during use, or for any consequent inconvenience or losses that may result.

MEMO



<https://www.aiphone.net/>

AIPHONE CO., LTD., NAGOYA, JAPAN

Issue Date: Feb.2019 © P0219 MQ 61331