



AIPHONE[®]
Providing Peace of Mind



Residential, apartment & commercial solutions for all door entry specifications

GENERAL LINE CATALOGUE





AIPHONE experience and know-how

Founded in 1948 in Nagoya, Aiphone has grown to be one of the world's most respected manufacturer of intercom systems. The dedication of our 1800 employees and our constant focus on improved quality have earned us the leadership position we occupy today. **We now export our innovative products to more than 70 countries worldwide.** Through our strong commitment to Total Quality Management, we are constantly seeking ways to improve our products and processes. The result is a global reputation for **technological advancements**, a broad range of top-of-the-line products, and most important of all **customer satisfaction**.

DOMESTIC MARKET

The market created by today's trend of living alone has led to greater demand for practical solutions for increased individual comfort. Both entry security and time-saving room-to-room communication are key elements that can no longer be overlooked. Aiphone offers bespoke solutions which are tailored to each type of demand through a large range of audio/video entry security systems.

DESIGNED TO LAST

Every Aiphone system is the result of painstaking attention to detail: contemporary design, the finest quality hardware and circuitry, engineered, built and 100% pre-tested for sustained trouble free service.

SHARED MARKET

Entry security is a vital feature in the areas of shared living areas. The more occupants ask about who is calling before opening the gate, the more they increase their security and their sense of safety. Regardless of the type of building or community you live in, Aiphone will provide the long-lasting quality products with the latest technology with special accessibility features (visual, auditory, motor and cognitive).

SERVICE INDUSTRY

As today's communication in offices and industry has become an increasingly critical factor for both productivity and safety, so has the need for reliable intercom systems. Thanks to our uncompromising quality control, the Aiphone intercom systems are recognized as the most reliable in the world.

ISO 9001

Aiphone is the first global intercom manufacturer to receive ISO 9001 certification. ISO 9001 standards provide an immediate recognition of product quality almost anywhere in the world. Today, Aiphone SAS is certified ISO 9001 for its commitment towards customer services.

ENVIRONMENT: AIPHONE'S COMMITMENT

Aiphone has also acquired ISO 14001 approval, a successfully international reference for environmental requirements. All AIPHONE products comply with RoHS (2002/95/EC) directives, a commitment to avoiding the use of materials that are harmful to the environment.

IX IP SYSTEM WITH SIP & ONVIF PROTOCOL

05

IS IP SYSTEM

13

IS ANALOG SYSTEM

17

AX INTERCOM SYSTEM

23

JP VIDEO SYSTEM WITH TOUCH & 7" SCREEN

29

JO VIDEO SYSTEM WITH WI-FI & 7" SCREEN

33

GT AUDIO/VIDEO SYSTEM

37















INTERCOM FOR BUSINESS & INDUSTRY

43

GUIDE

To refine your choice and determine the best range compared to your market. Refer to the table below:

		HOSPITAL	SUPERMARKET	PARKING
				
				
IX	 IX-MB7-HB	✓		✓
IS IP	 IS-SOFT	✓	✓	
IS Analog	 IS-MV	✓	✓	✓
AX	 AX-8MV	✓	✓	✓
JP	 JP-4MED	✓	✓	
JO	 JO-1MDW	✓	✓	
GT	 GT-1C7	✓		
LEM-LEF TDH-TCM	 LEM-3	✓		
NIM	 NIM-20B	✓		

PRISON & POLICE STATION 	OFFICE 	HOTEL 	GOVERNMENT 	SCHOOL 	RAILWAY STATION 	INDUSTRY 
						
✓	✓		✓	✓	✓	✓
	✓		✓	✓	✓	✓
✓	✓	✓	✓	✓	✓	✓
✓	✓	✓	✓	✓	✓	✓
	✓	✓	✓	✓		
	✓	✓	✓	✓		
✓	✓	✓		✓		
✓	✓		✓			
	✓		✓			✓

The System You

The next generation of video intercoms, Aiphone's IX Series 2, offers new features to create safer buildings. Every peer-to-peer IX Series 2 station now integrates with compatible Cisco[®] SIP servers. The new system includes a 7" touchscreen master station which can toggle between ONVIF Profile S CCTV cameras and 1.3 megapixel video feed from intercom stations.



Can Rely On... IX2

Why you should choose Aiphone's IX2

- No wiring-distance limitations.
- Peer to peer configuration using PoE.
- Video and audio recording to SD card.
- Picture in picture video can show the door station camera and an overhead camera simultaneously.
- Newly designed IX panels which comply with DDA regulations.

NEW



- IX2 System Call Queuing and Transfer Functions.
- Call log facility on each handset provides data trails.
- Video intercom between master monitors.
- Audio and video SIP Integration with Cisco IP phone systems.
- ONVIF compatibility for intergration video surveillance system.



NEW
IX
SYSTEM

IX SYSTEM

NEW IX RANGE WITH
INTEGRATED SIP!



NEW IX SYSTEM

CAPACITY
No limit



NEW FOR 2018

Aiphone's IX integrated IP intercom and security solution has just become even more flexible, powerful and user friendly. Improved functionality and new stations ensure IX truly stands out from its competitors.

- Improved audio and camera functionality
- Larger touch screen monitors
- Up to 9,999 door stations, with no server required
- Video calling between master stations
- Interacts with other IP devices and systems
- SIP integration with Cisco

THE POWER OF IX SYSTEM

> COMPATIBLE WITH THIRD PARTY SYSTEMS

The IX system is compatible with ONVIF compliant IP cameras, enabling intercom and security door entry operations to be linked to third-party video surveillance systems.



> PEER TO PEER CONFIGURATION RESULTS IN SPACE SAVINGS, REDUCED INSTALLATION TIME AND LOWER COST

Simply connect the units to Power over Ethernet (PoE) switches. No need for a dedicated server, with the additional benefit of eliminating the risk of system downtime due to server malfunction.

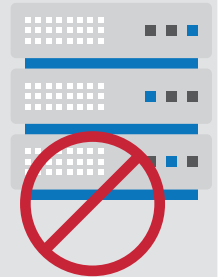

> NO WIRING-DISTANCE LIMITATIONS

LAN and VPN connections enable implementation over extensive areas and between remote locations. This allows for closed circuit communication and central control in large facilities, between corporate and satellite offices, and any type of application with multiple locations.

> POE DESIGN

Electrical power is supplied over the LAN port connection.

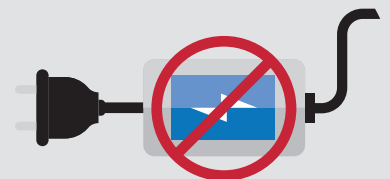



**NEW
IX
SYSTEM**

CAPACITY
No limit

IX

INTEGRATED IP INTERCOM AND SECURITY SOLUTION

Aiphone's IP network based IX intercom system provides communication with a practically infinite number of doors and is designed to interact with other IP devices and security systems.

> AFFORDABLE

IX series is scalable up to 9,999 door or room stations and with no server required and no licence fees, it could not be simpler with minimal installation time and cost to add additional units onto the network infrastructure, regardless of the size of the initial project.

> FLEXIBLE

IX has been designed to provide users with a flexible solution which offers the opportunity to mix and match a large number of door and master stations to match specific project requirements.

> SCALABLE ACROSS THE NETWORK

The IX system offers video entry security, internal communication, emergency stations and multicast paging.

All these functions can be implemented between remote locations over large areas and distances, making IX an ideal solution for any type of application involving multiple locations such as airports, education campuses, railway stations and parking facilities.

> SEAMLESSLY PART OF THE BIGGER SECURITY PICTURE

What elevates IX above other intercom systems currently available for large scale installations, is the ease at which it can be integrated with third-party systems such as Access Control, IP network cameras and video management software (VMS), to provide a total integrated security solution. IX is compatible with a long list of ONVIF compliant IP cameras and leading VMS such as Avigilon™, ExacqVision and Milestone, as well as Lenel Onguard access control management software.

> MOBILE APP

IX series' key features can be accessed remotely via a free mobile app available from the Apple App Store and Google Play Store. The app enables users to receive calls on their Android™ and Apple® smartphones from any IX Series intercom unit and activate release contacts such as door strikes.

NEW IX SYSTEM

CAPACITY
No limit

THE « PLUS »

> PRACTICAL AND ACCESSIBLE



IX-DV
Video door
station

- Introducing features and functions which offer real-world practical benefits
- The IX system is an Accessible solution with both audio and visual prompts for visitors and offers options for both handset and hands-free communication.
 - Customised messaging can be created or imported to provide additional guidance to visitors
 - SIP integration with Cisco ensures IX system is accessible to more users on the system without additional hardware
 - Multi purpose adaptor (IXW-MA) provides 4 contact inputs and 10 relay outputs to link and provide two way control of various devices.
 - Error and health check reports sent to specified email address
 - Audio and video can be recorded via SD memory slots on master and door stations to protect against loss of data if there is a network failure
 - 7" touchscreen monitors make it easy to navigate around controls and see clearly who is at the door
- Plus almost endless options for manual, delay, absent and schedule transfer of calls, as well as simultaneous calls to multiple devices.

FEATURES

> AUDIO AND VIDEO MASTER STATION



IX-MB7-B
Audio and video
master station

- Directly connectable to an IP network
- 7-inch touch display for easy operation and video monitoring
- Camera with privacy cover
- A variety of display modes designed for different situations
- Hands-free, push-to-talk
- Direct voice call from master station to another station
- Video image adjusting function
- Record audio and video to a micro SD card at the start of or during a call
- Play an audio or video recording saved to a micro SD card on a computer
- Call or communication transferring to another master station
- Paging to a group or all stations
- Message paging: Broadcast messages and notifications through the system
- External input paging: Send a page using contact and external sound inputs
- Monitor other stations

THE RANGE

> IP AUDIO AND VIDEO HANDS FREE MASTER STATION



IX-MV-7B
IP video master
station
Black finish
7" touch screen



IX-MV-7W
IP video master
station
White finish
7" touch screen



IX-MV-7HB
IP video master
station
Black finish
7" touch screen



IX-MV-7HW
IP video master
station
White finish
7" touch screen

THE RANGE

> IP AUDIO SUB STATION



IX-RS-B
IP audio
sub station
Black finish



IX-RS-W
IP audio
sub station
White finish

FEATURES

- Calling up to 20 pre-programmed stations simultaneously
- Door release
- Send emails: an email can be sent to pre-registered email addresses when triggering events occur

> DOOR STATION



IX-DV
Video door
station

- Aluminium
- Surface wall-mount
- PoE-802.3af/at
- Input/Output:
 - Contact input x 6
 - Relay output x 2
 - Audio output x 1



IX-DVF
Video door
station

- Stainless steel
- Flush wall-mount
- Mounting box included
- PoE-802.3af/at
- Input/Output:
 - Contact input x 6
 - Relay output x 2
 - Audio output x 1



IX-SSA
Audio door
station

- Stainless steel
- Flush wall-mount
- PoE 802.3af/at
- Mounting box included
- Input/Output:
 - Contact input x 6
 - Relay output x 2
 - Audio output x 1



IX-SS-2G
Audio door
station

- Stainless steel
- Flush wall-mount
- PoE-802.3af
- Input/Output:
 - Contact input x 1
 - Relay output x 1

DIMENSIONS (mm)

IX-MV7B / IX-MV7W

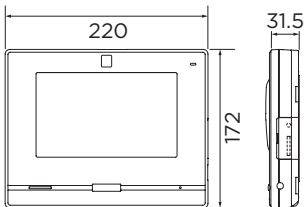

IX-DV

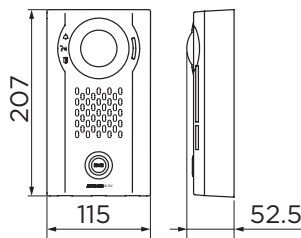

IX-DVFA

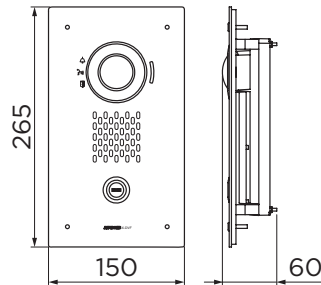

IX-RSB / IX-RSW

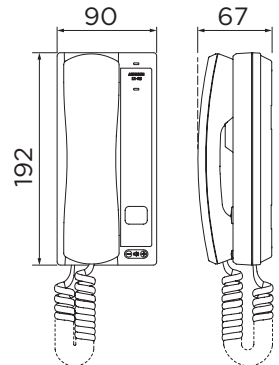

IX-MV7HB / IX-MV7HW

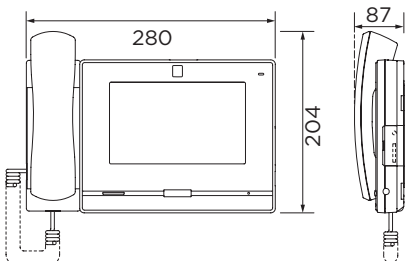

IX-SS2G

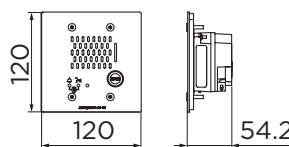

IX-SSA

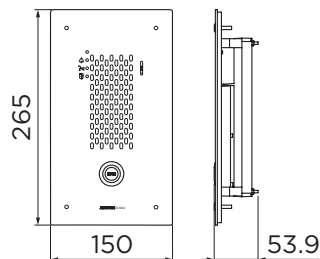

IX SYSTEM

CAPACITY
500 IP addresses



IX-DF

IP door station
with camera

THE « PLUS »

- Long distance management of remote sites over VPN
- Centralised management at a given point
- Remote access control of sites without employees
- Reduced installation costs
- The IX uses the ONVIF protocol and installations are full IP

FEATURES

> DOOR STATIONS

- Ultra robust and vandal resistant
- Stainless steel front panel
- Flush and Surface options available
- RJ45 wiring using CAT6 cable
- Full IP 1 address door station
- Colour camera with night vision lighting
- Powered by POE (Power Over Ethernet) 802.3 AF
- Configuration via PC software
- NO/NC contact on door station

> MASTER STATIONS

- IP installation powered by POE
- Hands-free or handset communication
- Menu access display
- Visitor viewing
- 6 direct call keys
- Number pad for calling other master stations
- Automatic or manual call transfer
- Live or pre-recorded message broadcast (audio broadcast)
- Make announcement to a zone or another station on the system
- Adjustable brightness
- Adjustable ringer and audio volume
- Adjustable contrast
- System status indicators: emergency call, privacy enabled, busy, announcement in progress, etc.
- Wall fixing (mount included) or desktop (desk stand included)
- Configuration by PC software



IX-MV

Master
video station



PARKING



For the **safety of your visitors** but also to answer to the demands of your managers and park agents in terms of **speed** and **efficiency**, the **IX solution** is ideal for parking.

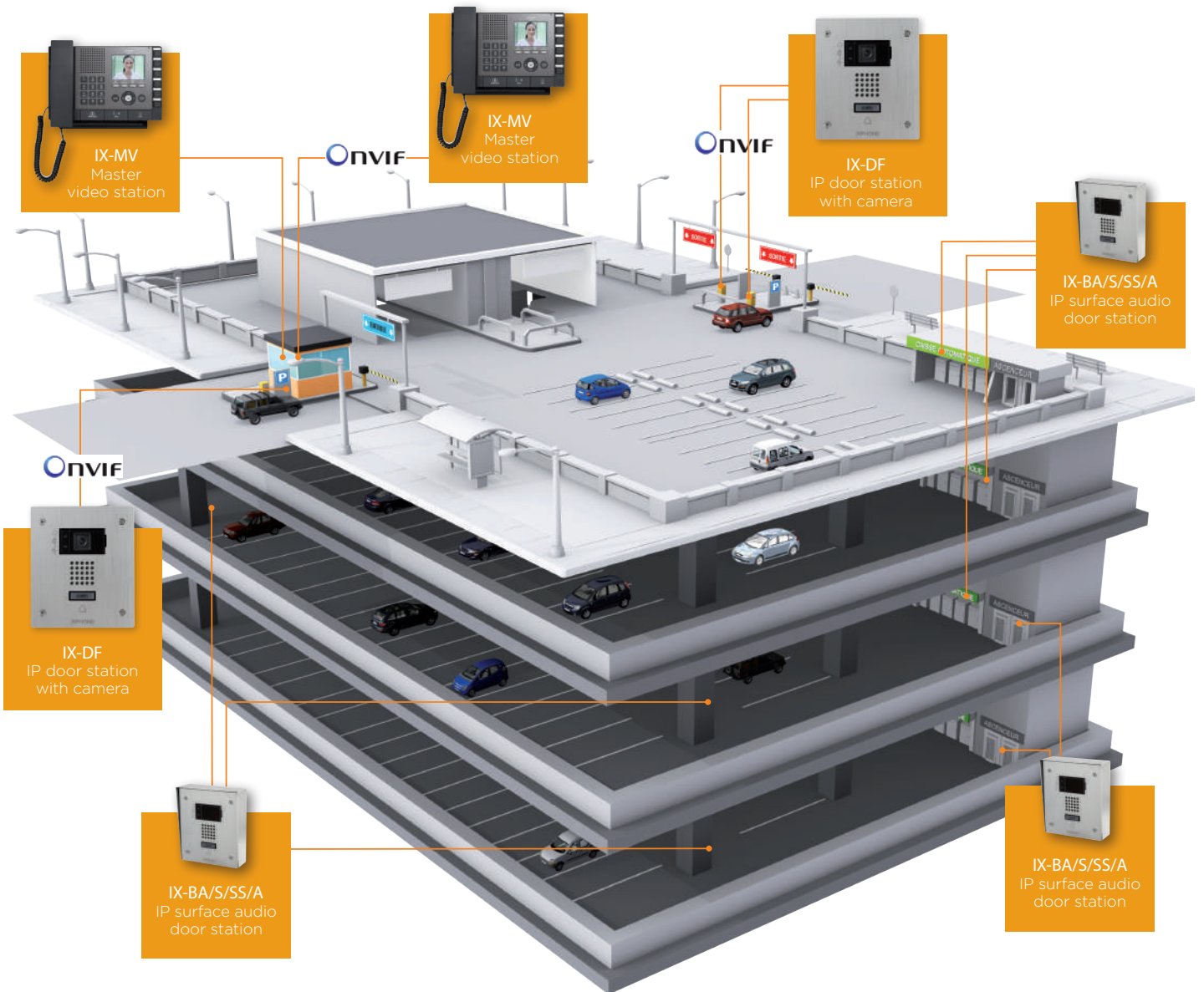

DIMENSIONS (mm)

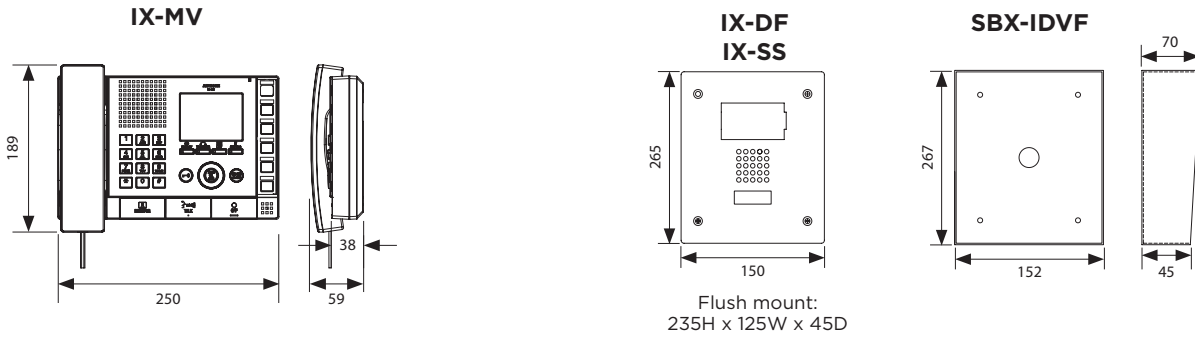

WIRING

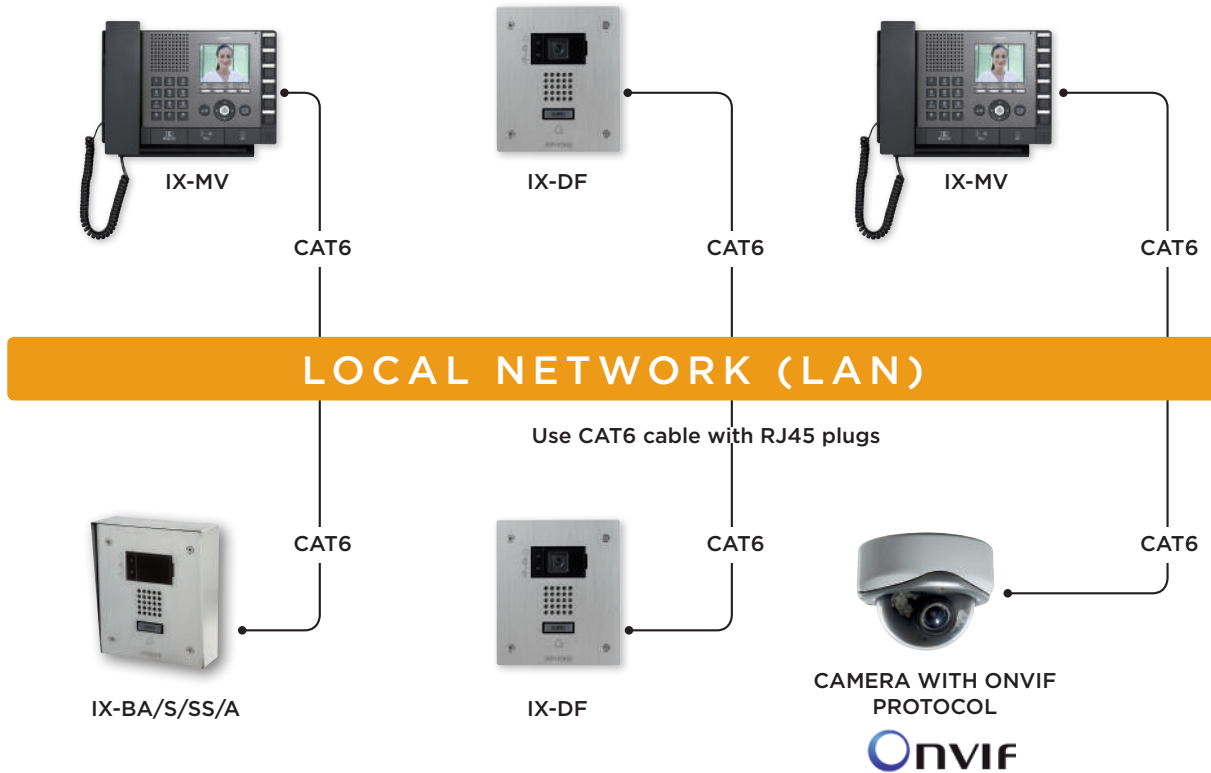

Use CAT6 with RJ45 socket



The IX works over LAN, VLAN and VPN. Direct WAN installation is not possible

IS IP SYSTEM

IS IP SYSTEM

ANY DISTANCE, ANY BUILDING,
CENTRALIZED SECURITY
MANAGEMENT, IP



IS IP SYSTEM

MAXIMUM CAPACITY 32 IP addresses

The IS solution allows you to perform an installation without distance constraint for multi-building sites.

In addition, the management and administration of the different accesses can be managed remotely.

The IS solution is economical because it uses an existing infrastructure: the network already wired in CAT6!

The IS system's IP network has a capacity of 32 addresses. It is made up of a maximum of:

- either 32 Full IP products
- or 8 IP control units + 24 full IP products (24+8 = 32).

THE "PLUS"

- Capacity of 32 addresses
- Full IP installation in PoE
- Receiving calls on a desktop PC
- Works in local network or on the internet
- Long distance solution: no more constraint via IP
- Wide angle 170° camera with zoom
- Image memory with IS-SOFT software

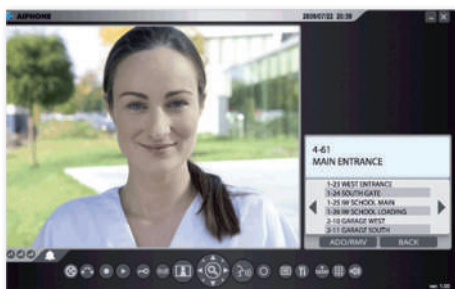

IS-SOFT

Software for IP-addressable stations

SERIES PRESENTATION



IS-IPDV

IP-door station with wide-angle camera, die-casting metal, surface-mount



IS-IPDVF

IP-door station with wide-angle camera, stainless steel, flush-mount

DIMENSIONS (mm)

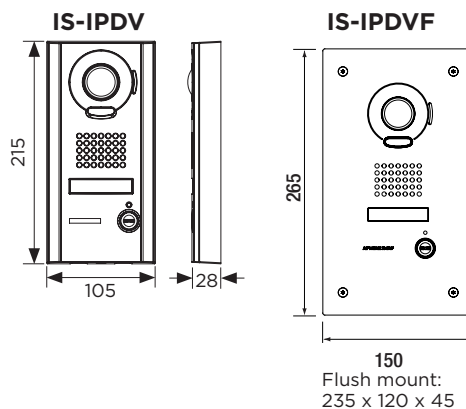

FEATURES

- Internal communication
- Entry management
- Call transfer on the PC, management software with call memory.

PC CONFIGURATION*

- **Operating system:** Windows® Vista (SP1), or Windows® 7 (32/64 bit)
- **Processor:** 2 GHz or higher
- **System memory (RAM):** 1 GB RAM or more
- **Hard drive:** 10 MB or more (additional space required for recording)
- **Sound card:** 8-bit full duplex, Direct Sound compatible
- **Executable:** Microsoft(R) .NET Framework 4.0 or later version
- **Network:** 10BASE-T/100BASE-TX Ethernet

* PC not included

ADMINISTRATION



In buildings such as a town hall or a museum, security is a daily priority. **IS IP solutions are designed to answer your expectations and ensure effective protection of people and goods.**



IS-SOFT
PC software



IS-IPDV
IP-door station with wide-angle camera, surface-mount

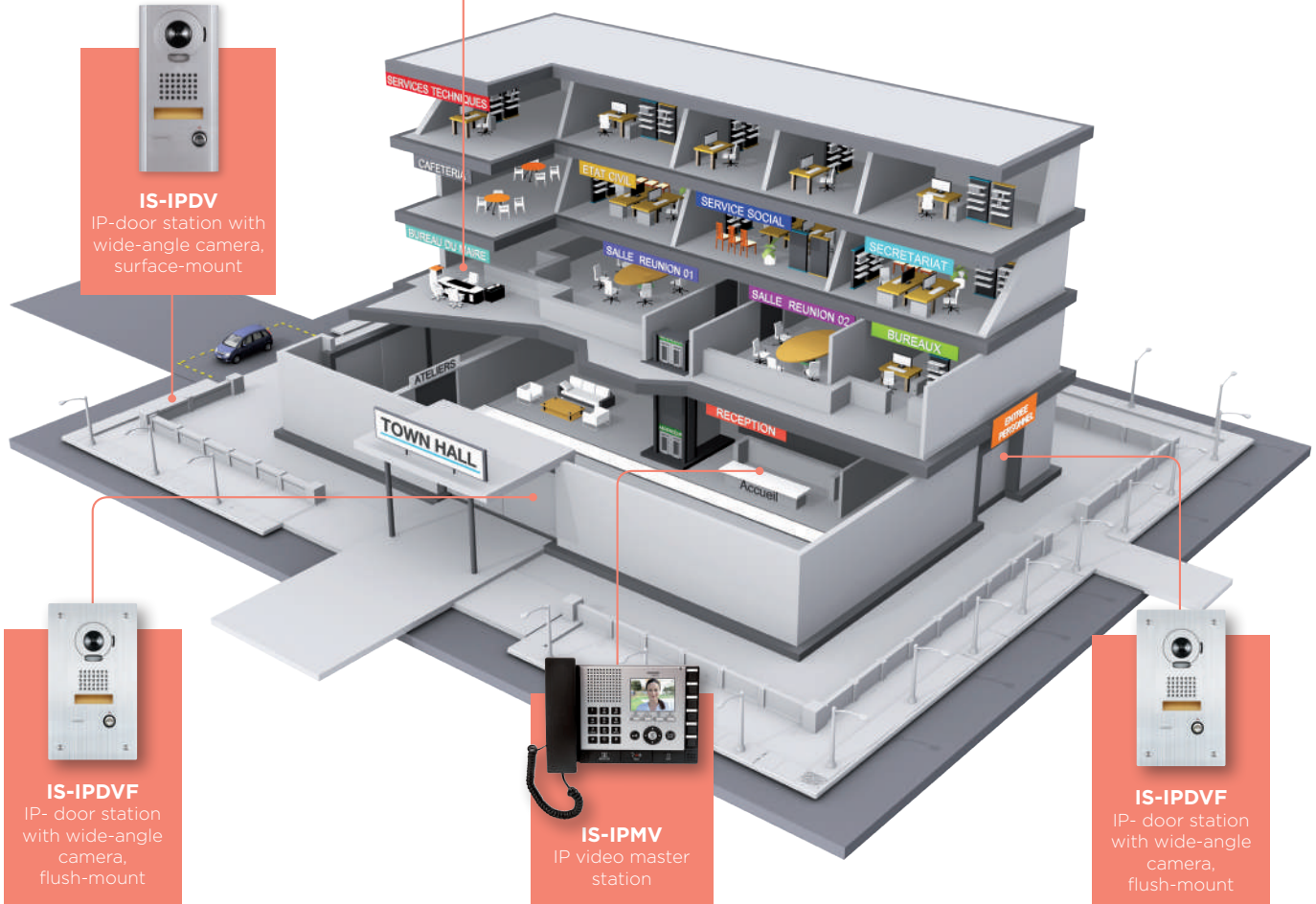

IS-IPDVF
IP-door station with wide-angle camera, flush-mount



IS-IPMV
IP video master station



IS-IPDVF
IP-door station with wide-angle camera, flush-mount

MASTER STATION & CONTROL UNIT



IS-IPMV
IP-addressable video
master station



IS-IPC
IP control unit: can take one
IS-CCU or one IS-RCU
(up to 8 IS-IPC per network)

DIMENSIONS (mm)

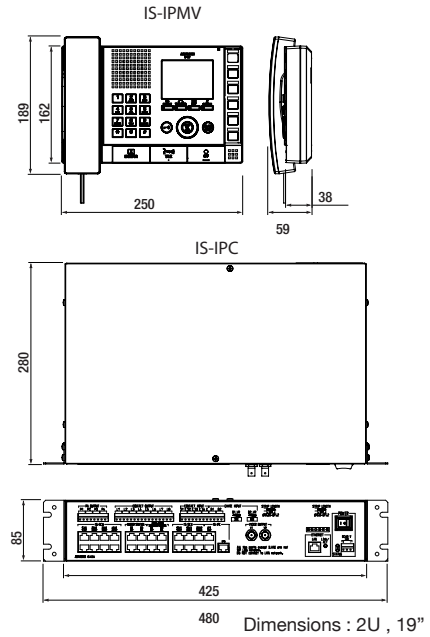

WIRING

Site N°1 - max. 32 IP addresses

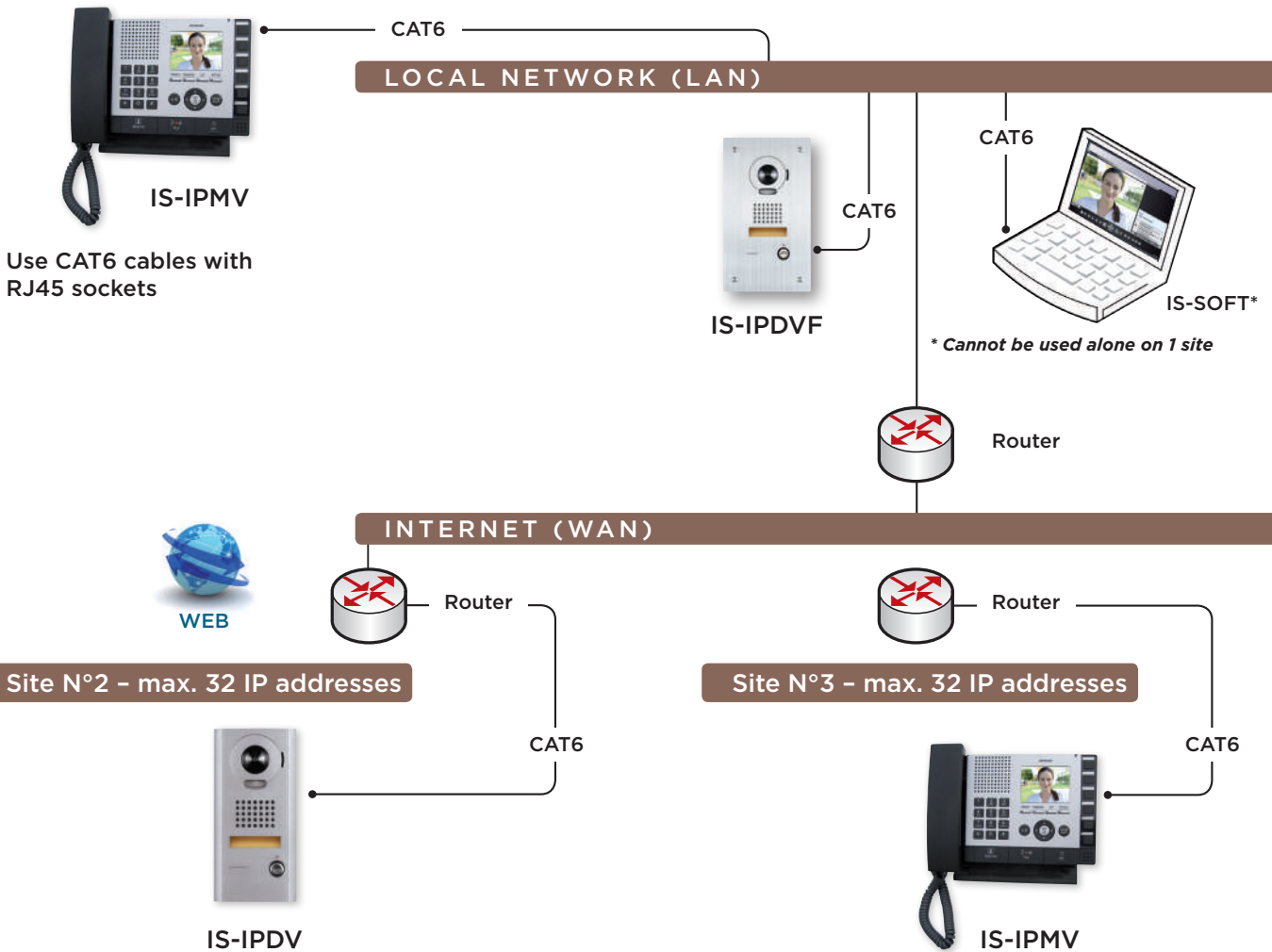

All of these devices can be powered by PoE or an external power source
PS-2420DM

ANALOG
IS
SYSTEM

ANALOG IS SYSTEM

AN ADAPTED SOLUTION
FOR AN ANALOG INTERCOM
CONFIGURATION



ANALOG
IS
SYSTEM

CAPACITY
20 DOORS > 20 MASTER
STATION



IS-DV
Door station with wide-angle camera, die-casting metal, surface mount

THE "PLUS"

- Wide angle camera 170° horizontal and 100° vertical
- Panoramic view with 9-zone zoom
- Handset or hands-free communication
- 4 priority levels of communications (EMERGENCY-PRIORITY- NORMAL-MONITORING)
- 2 independent communication channels per control unit
- Call forwarding and transfer on master stations
- General call on all the installed devices

FEATURES

> **MANAGES ENTRANCES TO MULTIPLE SITES**

The system covers all entrances. Calls may be forwarded from one master station to another.

The video door station is fitted with a panoramic camera: 170° horizontal and 100° vertical with 9 zoom areas.

> **EMERGENCY CALL POINTS**

A call from a substation or a door station can be programmed as urgent. If so, current communications will be interrupted to allow the call to take priority.

> **BROADCAST ANNOUNCEMENTS**

In an emergency, you can make an announcement (or use a pre-recorded message) to evacuate the site or to keep staff informed.

SERIES PRESENTATION

> **DOOR STATION**



IS-DV
Door station with wide-angle camera, die-casting metal, surface mount



IS-DVF
Door station with wide-angle camera, stainless steel, flush mount



IS-SS
Audio door station, stainless steel, flush mount



IS-SS-2G
Stainless steel flush mount compact audio door station

SCHOOL



Whether it's a high school, a college or a university, **student and teacher safety is a key issue.** Aiphone offers you the solution adapted to each type of establishment.



analog IS

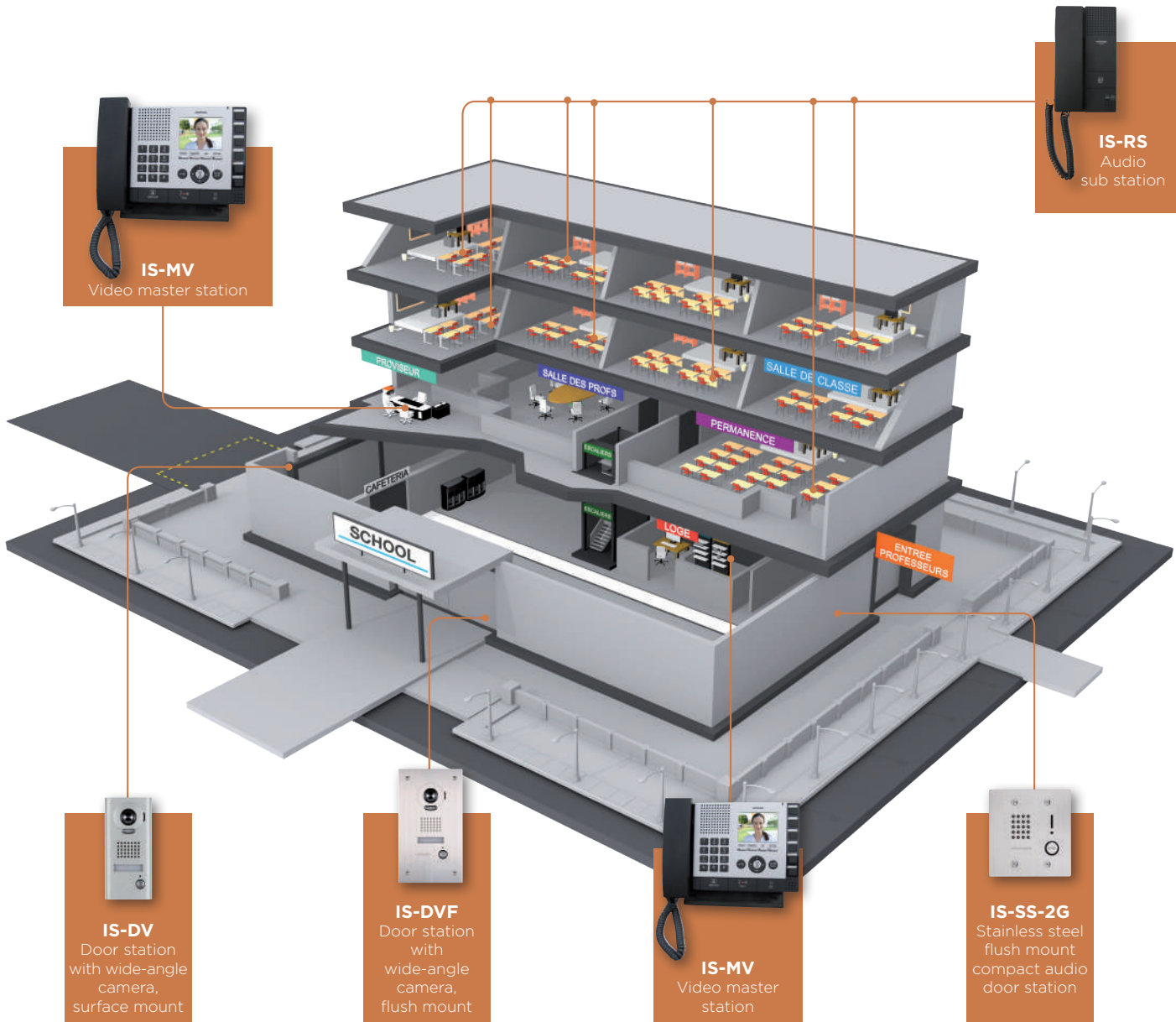

ANALOG SYSTEM CAPACITY

CAPACITY
20 DOORS > 20 MASTERS

































analog IS

Master stations

Door stations (1)

Audio stations (2)

Paging

 x 20	 x 20	 x 120	 x 28
 x 20	 x 20	 x 120	 x 28
 x 20	 x 20	 x 120	 x 28
 x 20	 x 20	 x 120	 x 28
 x 20	 x 20	 x 120	 x 28
 x 20	 x 20	 x 120	 x 28
 x 20	 x 20	 x 120	 x 28
 x 20	 x 20	 x 120	 x 28
Max 160	Max 160	Max 960	Max 224

(1) or audio door stations - (2) or IS-RS audio stations

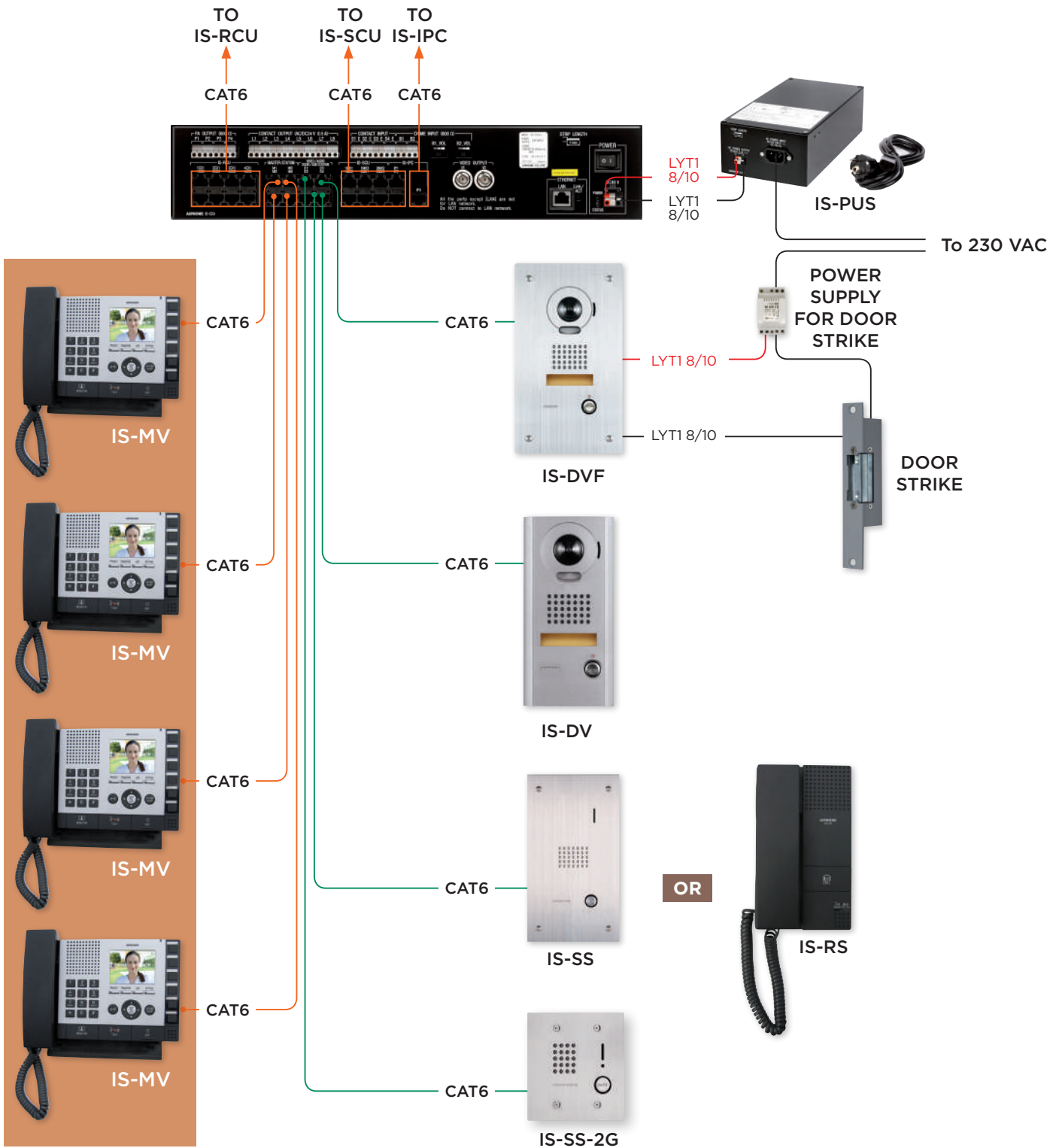

! Use CAT6 cables with RJ45 sockets

SERIES PRESENTATION

> Stations



IS-MV
Video master station



IS-RS
Audio sub station

> Control unit



IS-CCU
Master control unit: can receive 4 door stations/sub stations and 4 master stations



IS-SCU
Add-on control unit: can receive 8 door stations/sub stations and 8 master stations



IS-RCU
Add-on control unit for 30 sub stations



IS-PUS
Power supply for IS control units

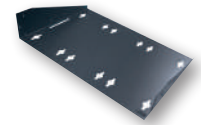

IS-RACK
Rack for installing 3 IS-PUS

analog IS

DIMENSIONS (mm)

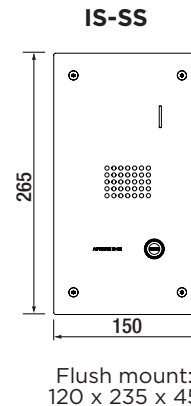
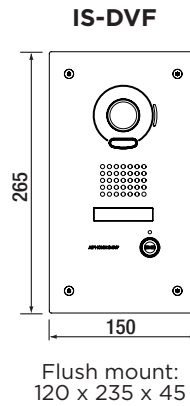
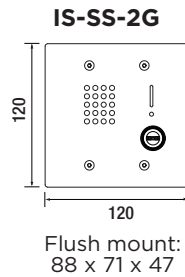
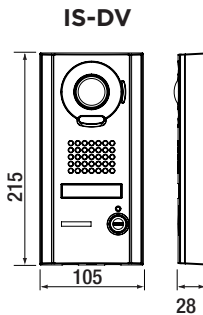
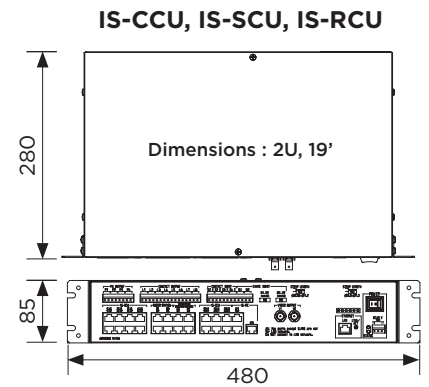
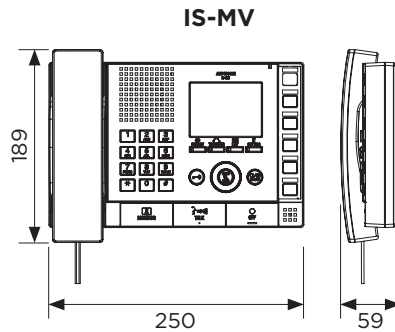
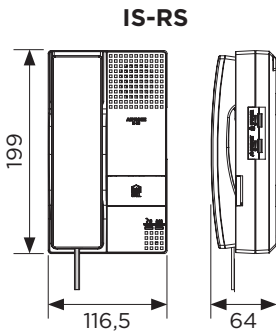



AX SYSTEM

MULTI-FUNCTION INTERCOM SYSTEM



AX SYSTEM

CAPACITY
120 DOORS > 8 MASTERS

THE "PLUS"

- Large capacity: 120 door stations
- Standard RJ45 / CAT 6 cabling
- Vandal resistant door stations
- Possibility to determine priority or normal calls
- General call and intercommunication between master stations
- 3.5" LCD screen (9 cm)



AX-DV
Vandal-resistant,
surface mount
video door station

FEATURES

- Receiving calls on all master stations
- Full-duplex or simplex hands-free conversation
- Internal call between master stations
- All call function for the master stations
- Call transfer (on telephone device) with optional telephone interface (without video transmission)
- Normal and priority general call
- Managing multiple calls (placing calls on hold)

SERIES PRESENTATION

> Video door stations



AX-DV
Vandal-resistant,
surface mount
video door station



AX-DVF
Vandal-resistant,
flush mount video
door station

> Audio door stations



S/IF-DAF
Vandal-resistant,
flush mount stainless steel
audio door station



S/IF-DAS
Vandal-resistant, surface
mount stainless steel
audio door station

OFFICES



Offices require a customized security plan. With the IS system, you can control all the offices remotely to optimize the security of staff and property.

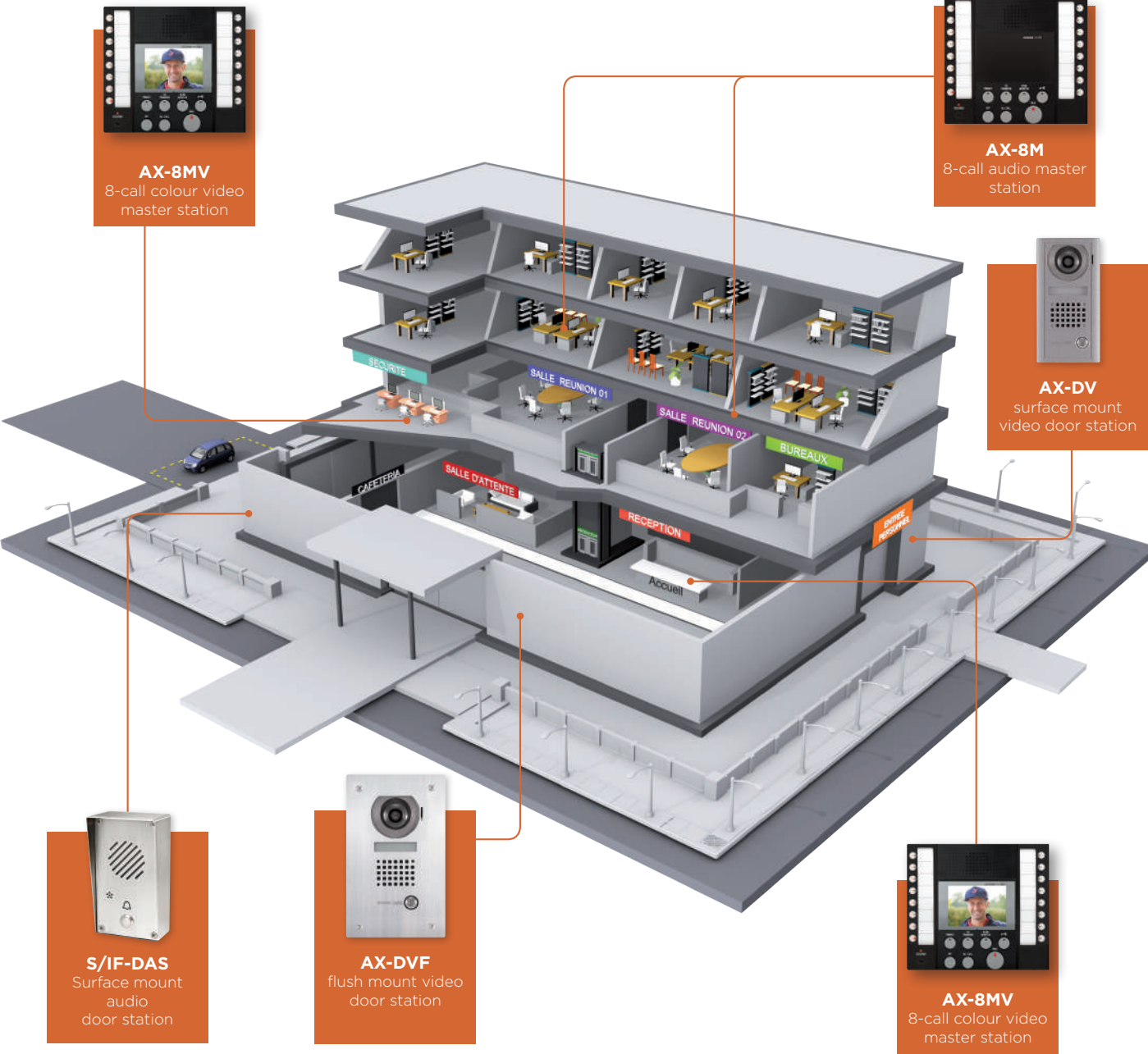

AX

SYSTEM CAPACITY

CAPACITY
120 DOORS > 8 MASTERS

AX

**Audio or video
master stations**

**Audio or video
door stations**

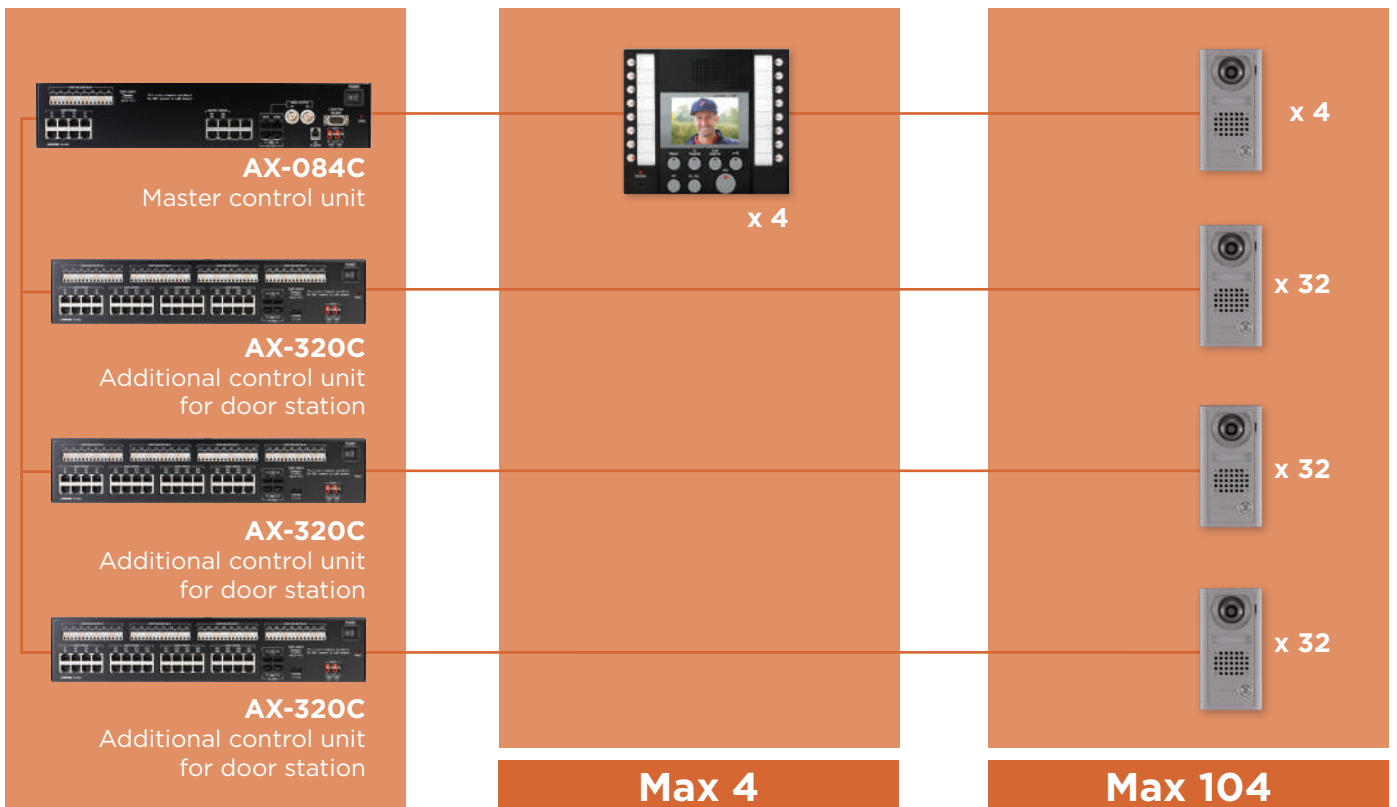
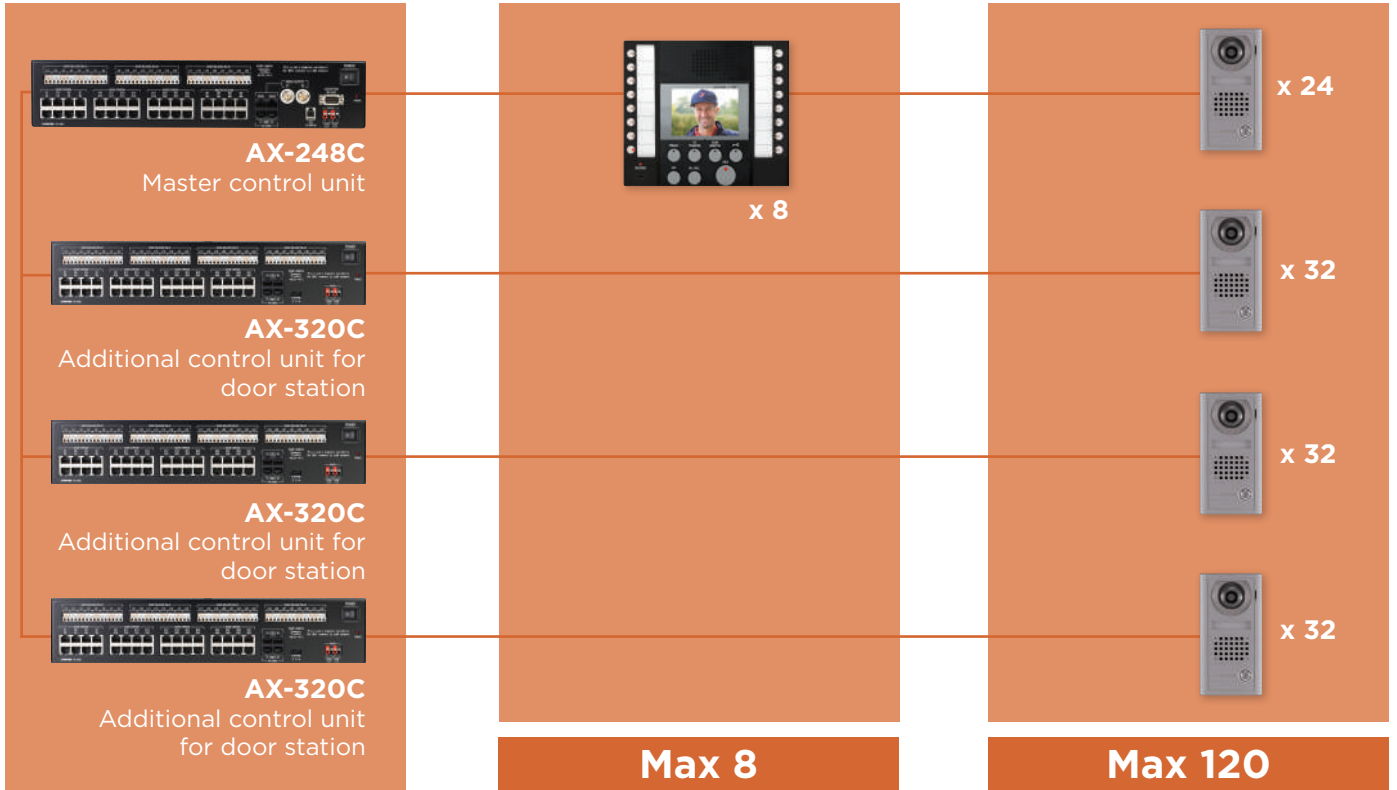

CAPACITY 120 DOORS > 8 MASTERS

WIRING

> Door stations

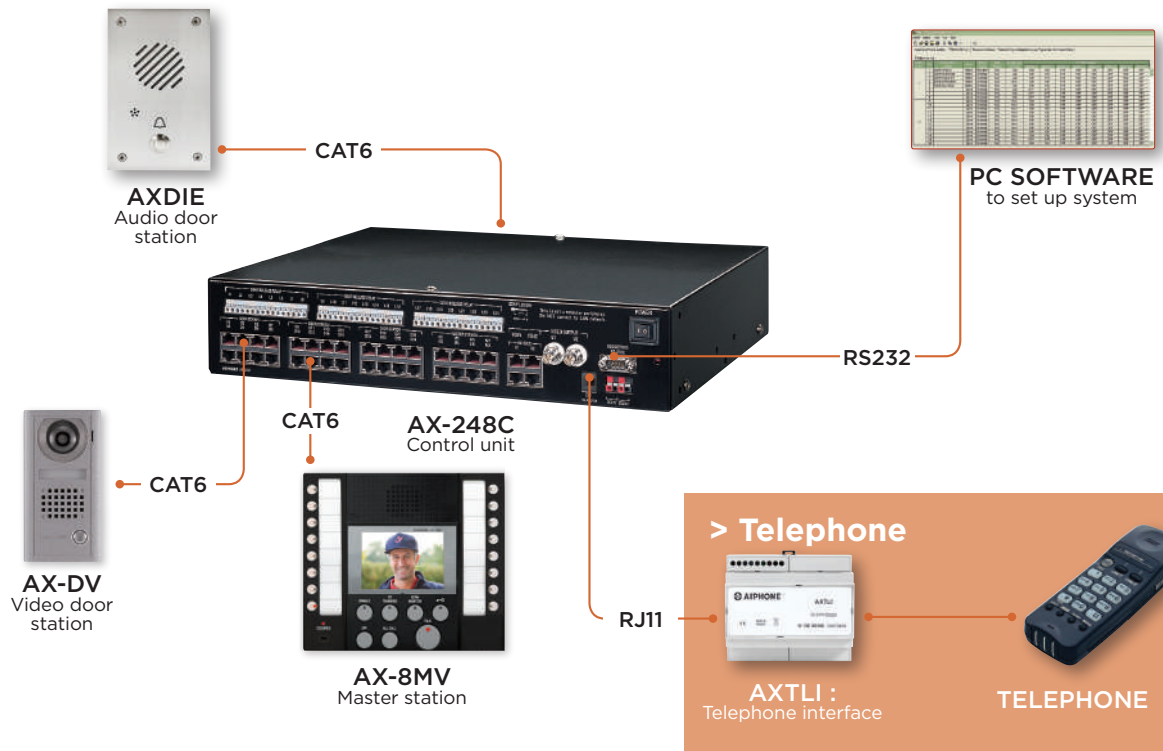

OPTION

> Telephone

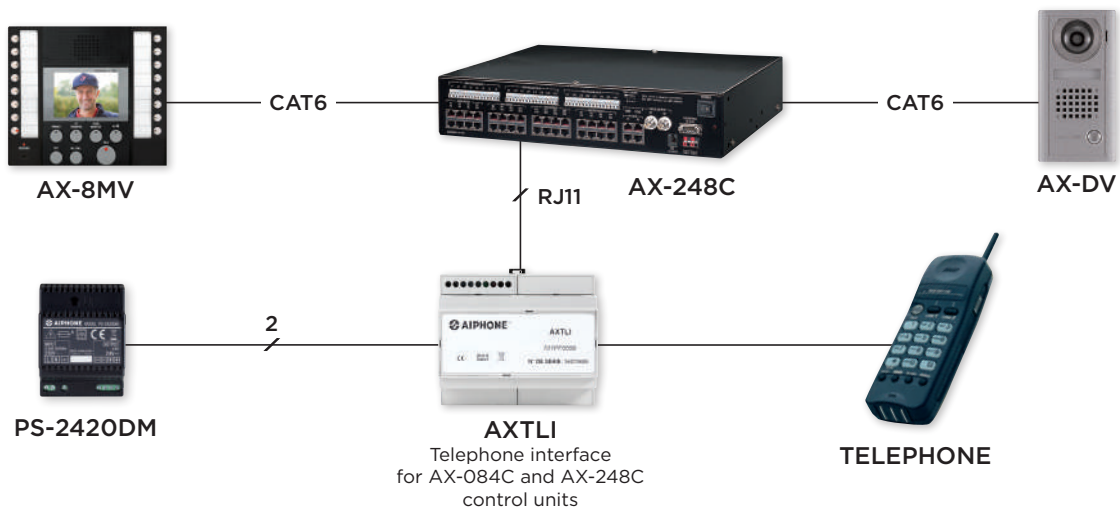

> Audio & video master stations



AX-8MV
8-call colour video master station



AX-8MV-W
8-call colour video master station.
White finish



AX-8M
8-call audio master station



AX-16SW
16-call add-on selector

> Control units



AX-084C
8-door & 4-master control units



AX-248C
24-door & 8-master control units



AX-320C
32-door add-on control unit

DIMENSIONS (mm)

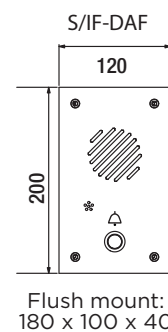
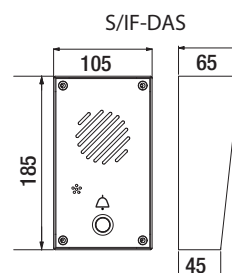
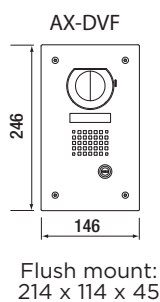
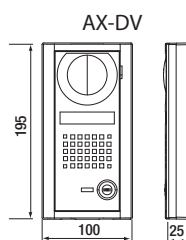
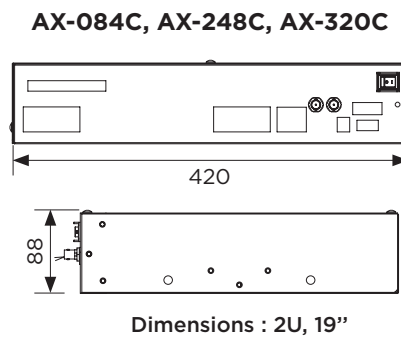
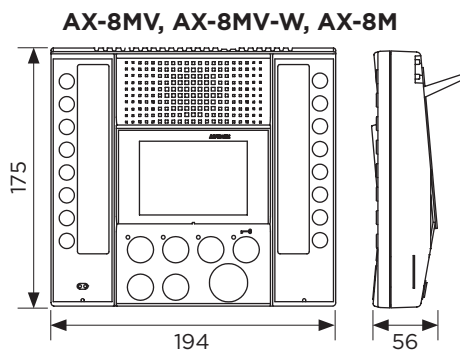



JP SYSTEM

THE JP SERIES IS A SIMPLE AND EFFECTIVE SOLUTION FOR ALL REQUIREMENTS





CAPACITY
8 ENTRANCES > 4 MASTERS

THE "PLUS"

- Monitor-controlled full screen mode, 170° wide angle and 9-zone zoom function
- IP interface to receive calls on your smartphone
- Picture storage capacity 1,000 calls on SD card (not included)



JP-DV
 Vandal-resistant, surface mount door station



BOX SETS AVAILABLE :
SURFACE DOOR STATION : JPS-4AEDV
FLUSH DOOR STATION : JPS-4AEDF

FEATURES

- Expand kits by adding up to 7 video monitors & 3 entrance stations
- 7" touchscreen
- Vandal-resistant, flush or surface mount door station
- Communicate hands-free or via the handset for added privacy
- RJ45 wiring - CAT6 between indoor stations
- Facility for connecting a remote NTSC or PAL camera
- Selective internal communication to substation or by broadcast call
- Transfer ongoing calls to another sub station

SPECIFICATIONS

- Power supply 24 VDC by PS-2420DM
- Door release Dry closure contact load breaking capacity 0.5 A 24 VDC or 24 VAC
- Wiring 2 wire from door station to master (+2 wire for door release) and CAT6/RJ45 from master station to the substations (and between sub stations)

SERIES PRESENTATION



JP-4MED
 Master colour station with memory



JP-4HD
 Sub master station



JPTLIIPA
 IP interface for JP-4MED monitor and JP kits



PS-2420DM
 24 VDC, 2 A Power supply

IP INTERFACE



JPTLIIPA
IP interface for smartphone

> Receive video calls from your door station on your smartphone

FEATURES

- Call on **3 smartphones, expandable to 5**
- Audio and video communication
- Requires WIFI, 3G or 4G connection
- **Email with picture alerting** if a call has been made during network failure
- Compatible with **iOS** and **Android** using the Aiphone JP app
- RJ45 wiring for the router connection
- Simple setup by scanning the QR code linked to JPTLIIPA
- **Not compatible with JPTLI installation**

WIRING

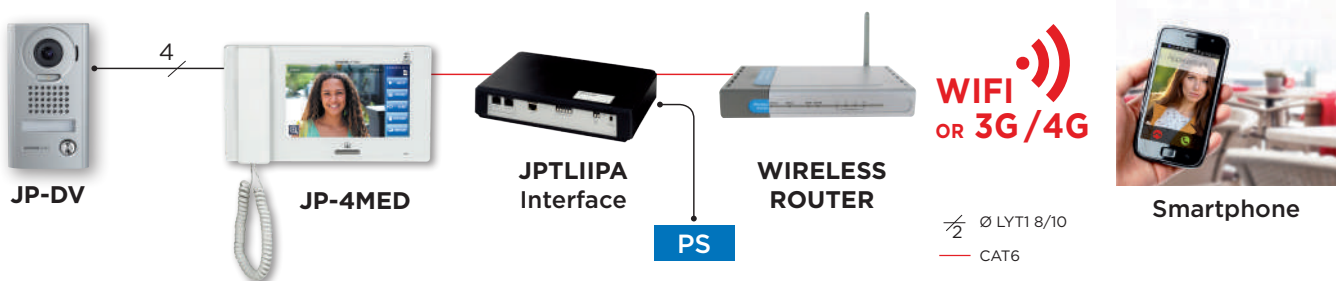

MAIN FUNCTIONS

Smartphone screen when using application JP

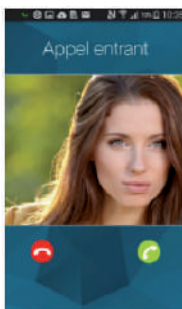

Incoming call

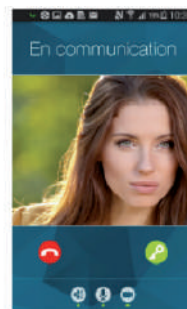

Communication

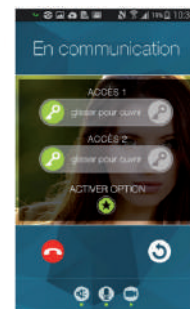

Opening door

DIMENSIONS (mm)

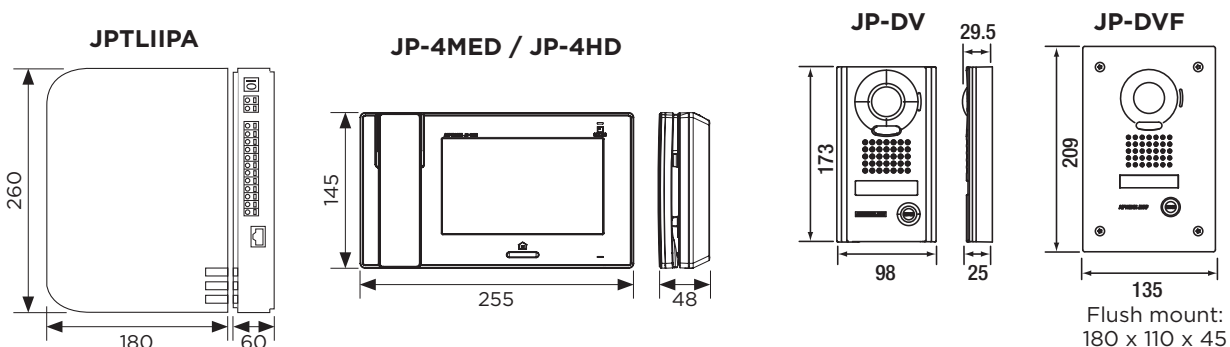

SERIAL TYPE WIRING

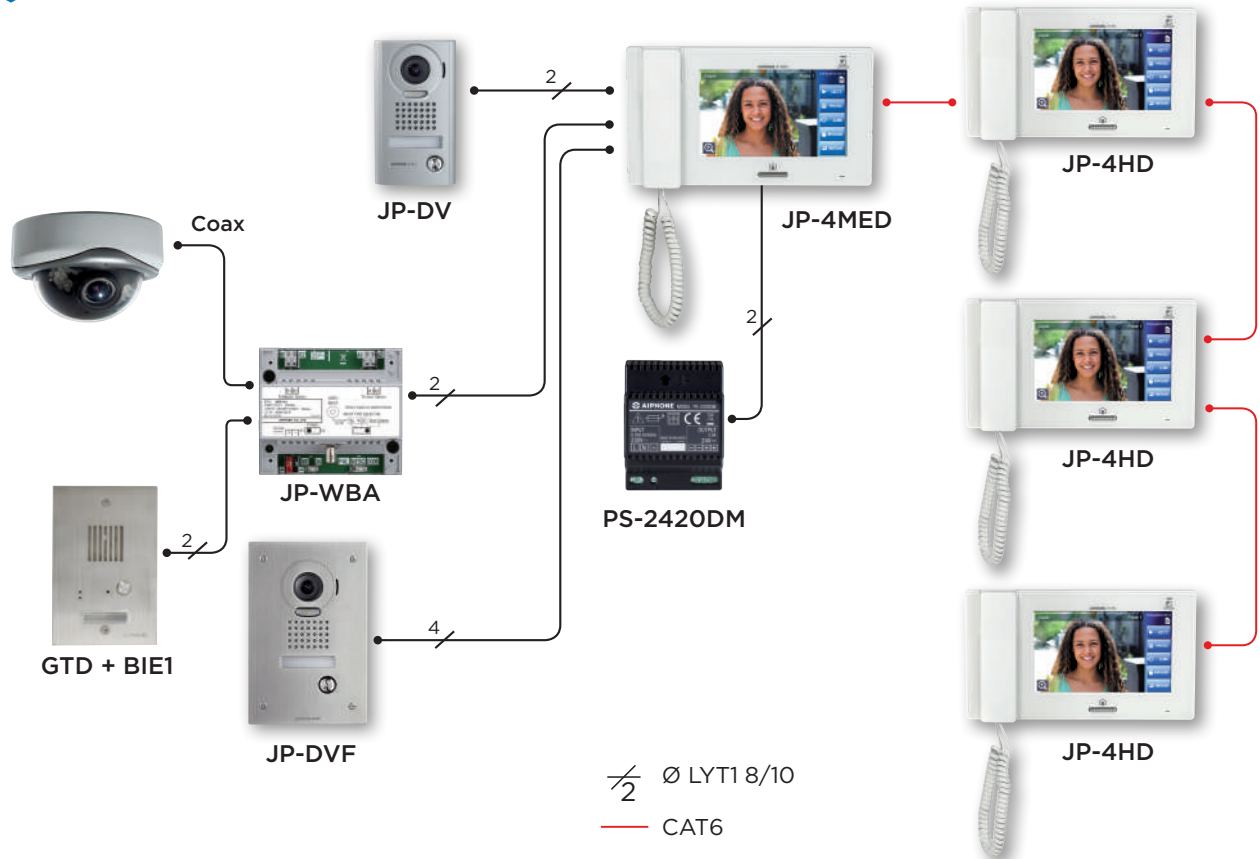

STAR TYPE WIRING

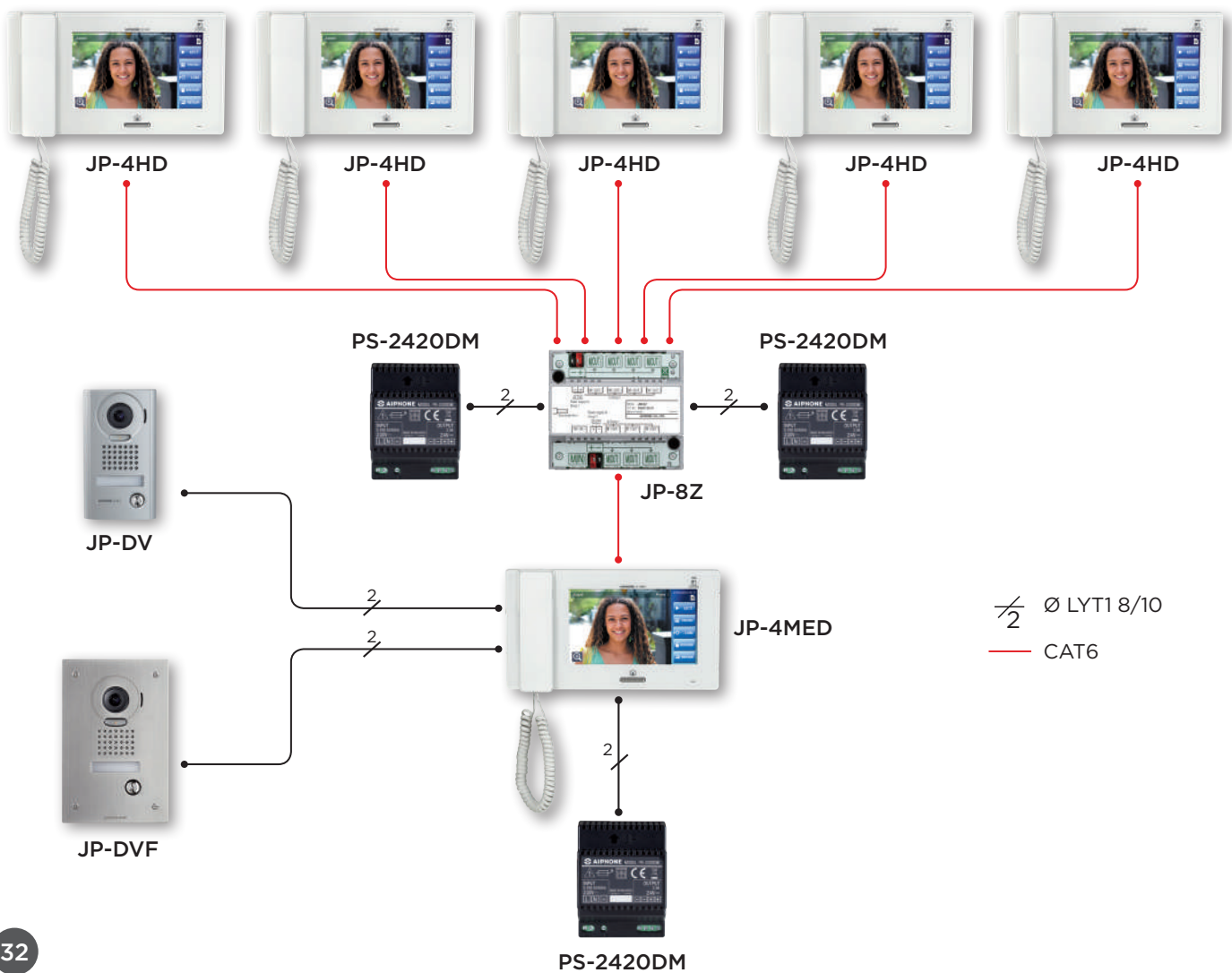



JO SYSTEM

THE VIDEO SYSTEM WITH
WI-FI MONITOR IS DEDICATED
TO RESPOND TO CALLS ON
YOUR SMARTPHONE WHEREVER
YOU ARE





CAPACITY
1 DOOR > 2 MONITORS

THE "PLUS"

- 7" touch screen
- Complete and intuitive menu
- Call up to 8 smartphones
- Monitoring from the smartphone available
- Monitor with integrated WI-FI
- SD card picture memory (SD card not included)
- Compatible with existing JO installation



JO-1MDW
Master station
with integrated Wi-Fi



BOX SETS AVAILABLE :
SURFACE DOOR STATION : JOS-1VW
FLUSH DOOR STATION : JOS-1FW

FEATURES

- Expandable kits with 1 additional video monitor
- Vandal resistant surface or flush door station
- Hands-free communication
- iOS and Android compatible with "JO" application
- Up to 8 smartphones registered on the system
- Call notification by "push" on the application
- Monitoring available from the smartphone

SPECIFICATIONS

- Door release Dry closure contact load breaking capacity 0.5 A 18 VDC or 18 VAC
- Wiring 2-wire (+2 wire for door release) from door station to the master station

SERIES PRESENTATION



JO-1MDW
Master station
with integrated Wi-Fi



JO-DV
Vandal-resistant,
surface mount door
station



JO-DVF
Vandal-resistant,
flush mount door station



PS-1820DM
Power supply

WI-FI MONITOR

> Receive video calls from your door station on your smartphone



JO-1MDW
Master station
with Wi-Fi integrated

FEATURES

- Call up to 8 smartphones
- Audio and video communication
- Requires WIFI, 3G or 4G connection
- Email with picture notification if a call has been made during network failure
- Compatible with iOS and Android using the Aiphone JO app
- RJ45 wiring for the router connection
- Monitoring available from smartphone
- Picture memory available from the smartphone
- Wi-Fi - WPS (WPS : **Wi-Fi Protected Setup**) Standard to simplify secure connexion of Wi-Fi equipment
- Simple setup by scanning the QR code

WIRING



MAIN FUNCTIONS

Smartphone screen when using JO application



Incoming call



Communication

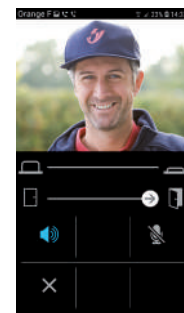

Opening door

DIMENSIONS (mm)

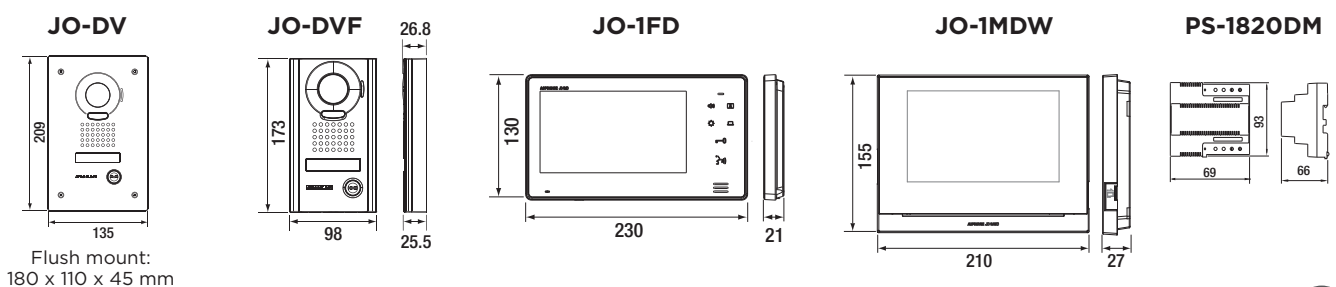

WIRING

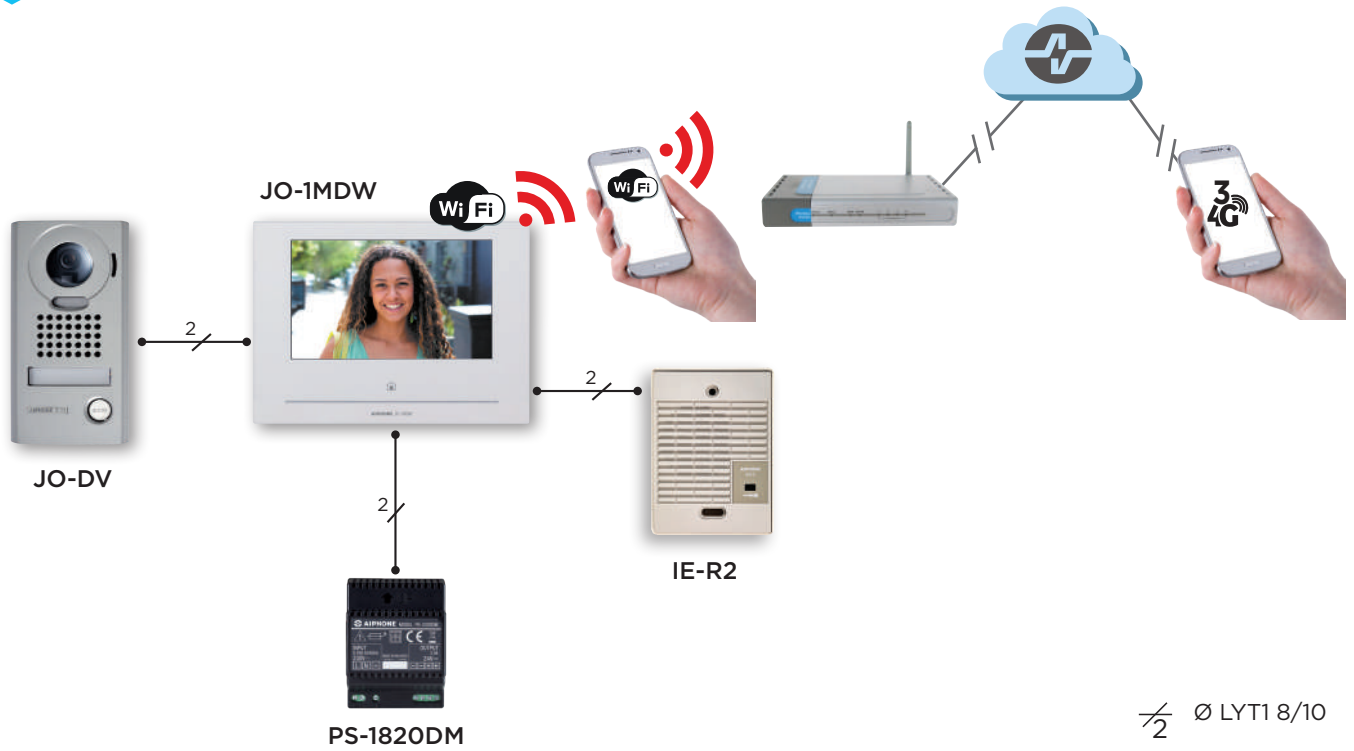

SUBSTATION WIRING

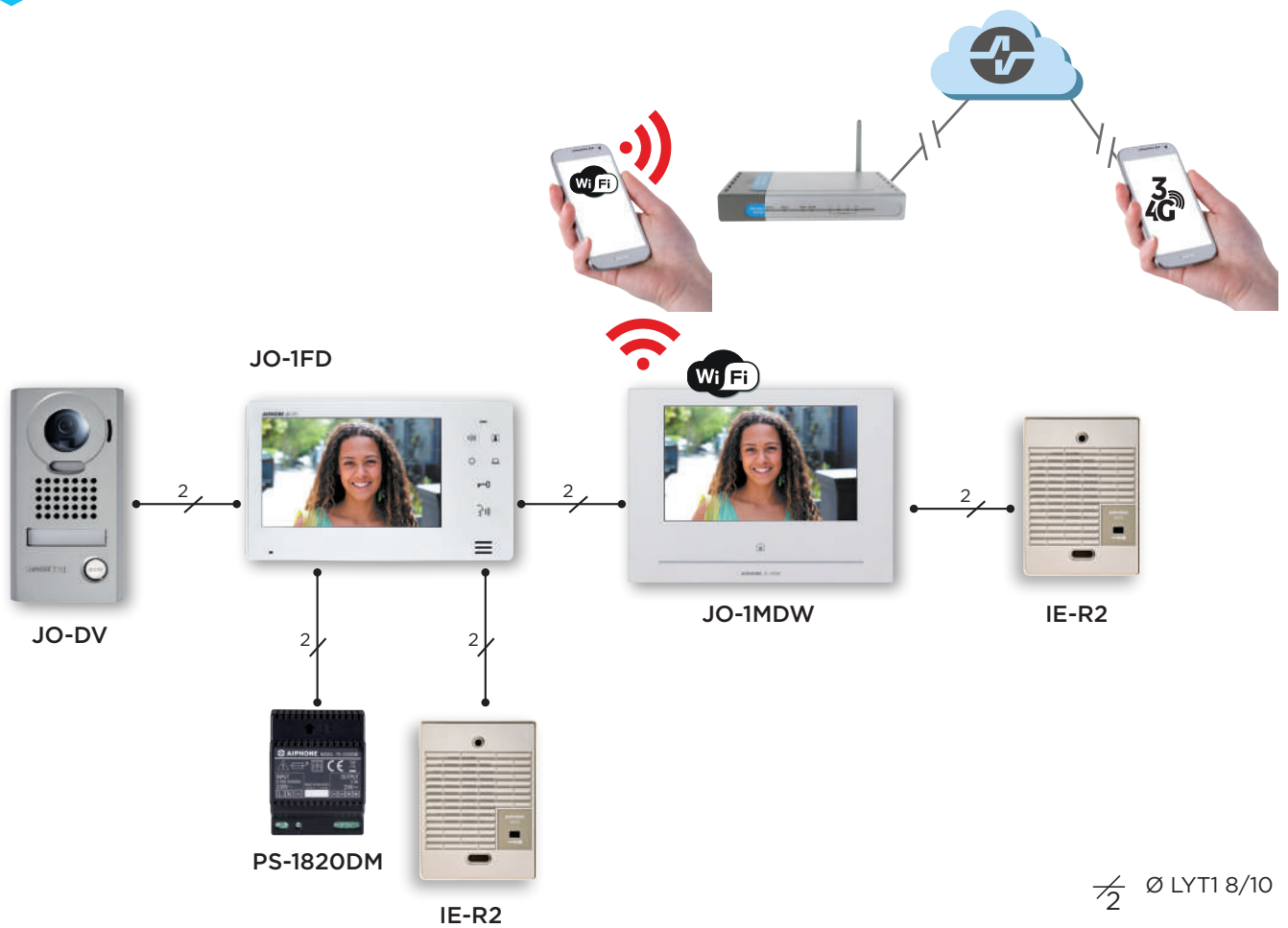



GT SYSTEM

A RANGE WITH TECHNOLOGICAL ADVANTAGES



GT SYSTEM

THE "PLUS"

> Monobloc door station:

- One piece 2.5mm thick stainless steel
- 3.5" colour LCD display protected by polycarbonate
- Presence detector for automatic illumination of the LCD screen.
- **NFC reader to update and manage the programming**

> Modular door station:

- High contrast with VFD display
- Robust die cast zinc



GT-DMB-N
Stainless steel door station
(GF-3B not supplied)

FEATURES

- Wide angle camera
170° horizontal and 100° vertical
- Display with 3 LEDs with 3 visual pictograms

DIMENSIONS (mm)

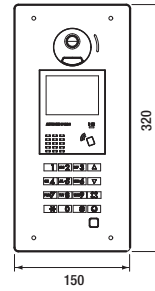

Flush mount
with GF-3B

ANTI-VANDAL DOOR STATIONS

> FLEX



Video Panel
with 2 Module spaces

STAINLESS STEEL CALLPOINTS FOR GT SYSTEM



2 Button Module



40mm x 40mm
reader Cutout



GTN-2/S/SS+CPM
GT video Panel 2 Buttons
and Prox reader Cut out

INFORMATION

Aiphone UK can provide stainless steel panels for the GT system and other systems to fit a wide variety of projects. Common designs include card reader cut outs, various button layouts, and halo illuminated buttons with braille. The modular design of our vandal resistant Panels allow us to provide complete stainless panels in a drastically reduced lead time. Non-specialized panels can be completed within 1 week. All panels come in either surface or flush mount. Bespoke engraving or sizes are also available with extended lead times.

FRONT PLATE



GTN-VDGS/SS

GT Video Digital Directory Panel



GTN-4A/S/SS/MDDA+IL

GT Audio Panel
with 4 Button Accessibility
Panel and Induction Loop



GTN-2A/S/SS/MDDA

GT Audio Panel
with 2 Button Accessibility Panel

ADD ON



Module for Access
Keypad (AC-10u)



Blank Plate



Card reader Cut-out
Panel Mount Size



Card reader Cut-out
Non-Panel Mount Size



Module for
Induction Loop

CALL BUTTONS



Button Panel with illuminated
Window Cut-out



Standard Button Panel



Accessibility Button Panel
Halo illuminated Buttons and Braille

GT SYSTEM

THE "PLUS"

- > **Video Monitor GT-1C7**
 - 7 inch screen
 - Wide angle 170 ° with zoom
 - Programming GT-2C-L, GT-1C7 and GT-1M3 sets possible by DIP switch
- > **GT-MKB-N**
 - Guard station with video screen and NFC reader for management.

FEATURES



GT-1C7
7" screen monitor, hands-free, wide-angle and zoom 9 zones

- **Several types of stations:**
 - > **GT-2C-L:** hands-free monitor with wide-angle view, 9-zone zoom, pictures memory and intercom with the other monitors of the apartment (GT-2H-L), optional handset GTHSA
 - > **GT-1C7:** 7" screen monitor, hands-free with wide-angle view and zoom 9 zones
 - > **GT-1M3:** 3.5" screen monitor, reduced width for renovation, hands-free with wide-angle view and 1-zone zoom
 - GTTLI phone interface for call forwarding
 - GTTLIP IP interface for call forwarding on smartphones
 - Audio station with handset

SERIES PRESENTATION



GT-2C-L
Color monitor, hands free and picture memory



GT-1M3
Color monitor, hands free



GT-1D
Audio handset



GT-MKB-N
Guard station with video screen and NFC



GTTLI
Telephone interface

DIMENSIONS (mm)

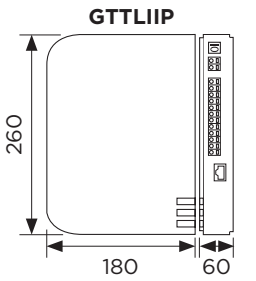
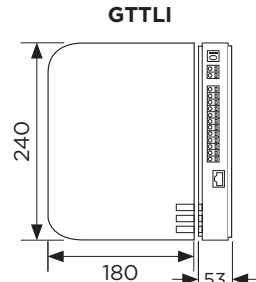
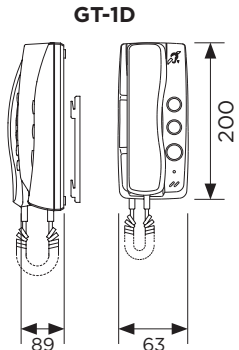
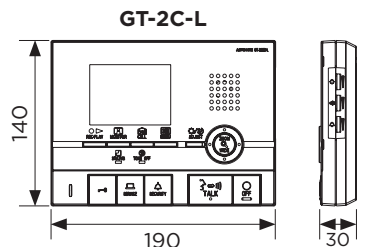
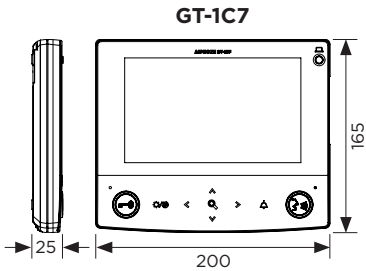
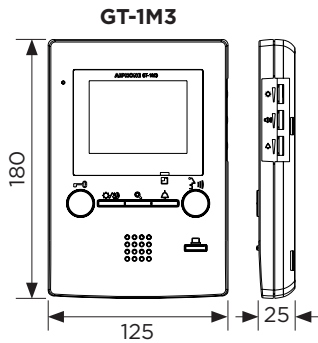

OPTION GTTLIP

IP INTERFACE

> Receive video calls from your door station on your smartphone

To improve security and simulate your presence, receive all calls of your GT intercom system on your Smartphone. Setting up is simple, after installation, you just have to flash a QR code to download the app then a second QR code to pair your Smartphone.

The application is compatible with iOS and Android.



GTTLIP
IP interface for GT

FEATURES

- **Call on 3 smartphones, expandable to 5**
- Audio and video communication
- Requires WIFI, 3G or 4G connection
- Email with picture notification if a call has been made during network failure
- Compatible with iOS and Android using the Aiphone GT app
- RJ45 wiring for the router connection
- Simple setup by scanning the QR code linked to GTTLIP
- **Not compatible with GTTLI installation**

MAIN FUNCTIONS

Smartphone screen when using application GT



Incoming call



Communication



Opening door

WIRING



> Standard system

5 entrance panel / 2 security guard station / 48 room station

WIRING

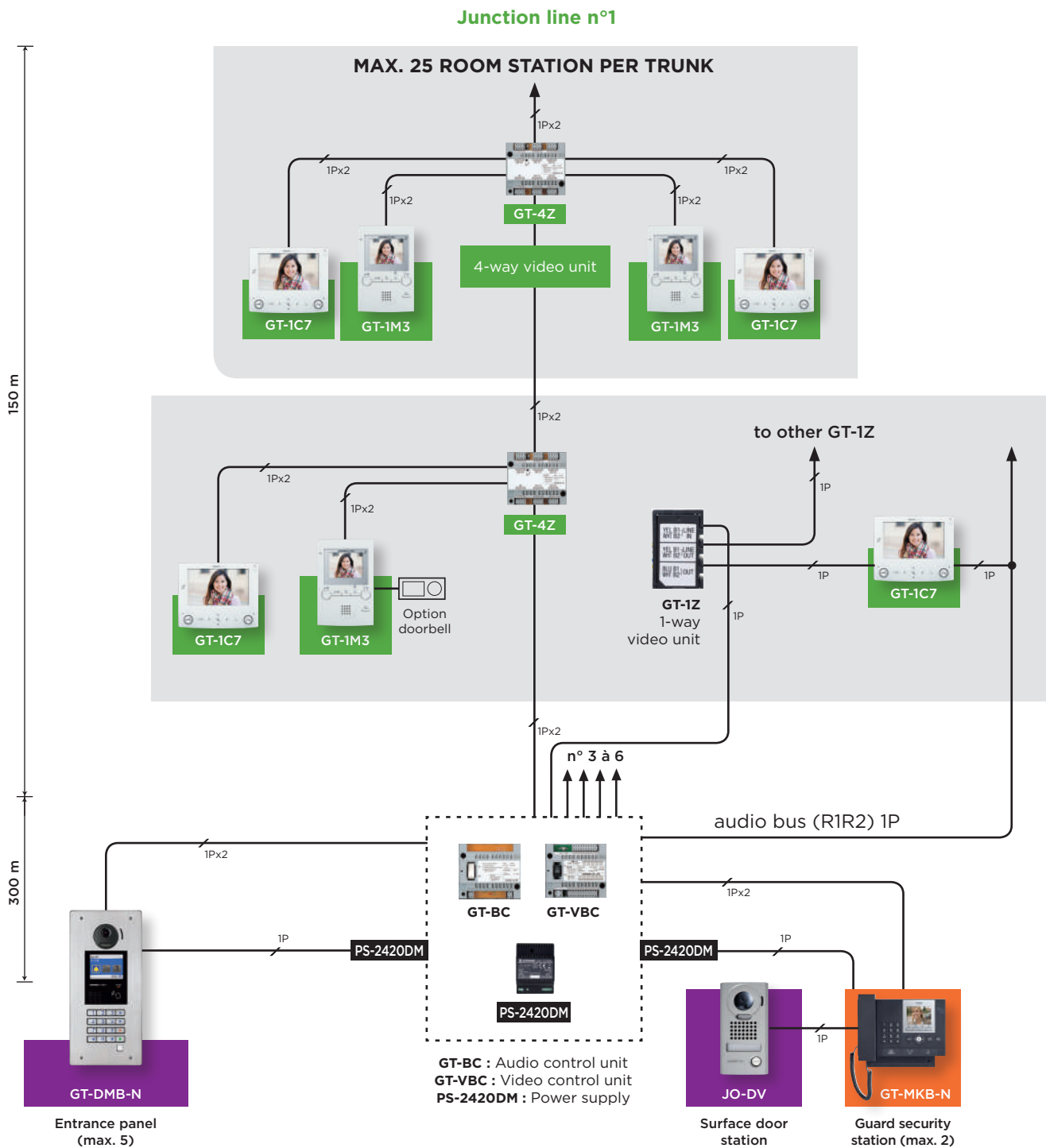

Wiring : 1 pair (P) x 2, Wired with 2 wires of solid copper, not twisted, polyethylene insulation

- Provide only 1 power supply for a group of 5 entrance panel
- Provide only 1 power supply for audio + video control unit

LEM/LEF
TDH/TCM
NIM
SERIES

LEM/LEF/TDH/TCM/NIM SERIES

COMMERCIAL INTERCOMS:
RANGES THAT SATISFY
ALL YOUR NEEDS



LEM SERIES

THE "PLUS"

- Possibility to install 3 door stations instead of sub station
- Hands-free conversation from sub to master
- Desktop or wall installation
- Call by tone or voice

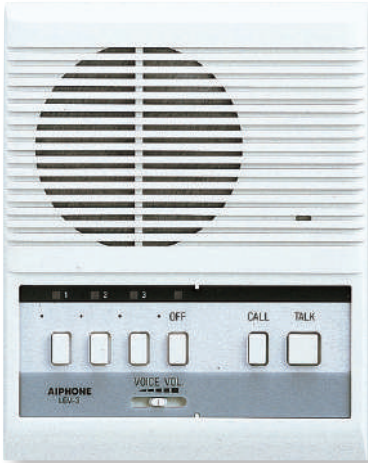

LEM-3
3-call Master

SERIES PRESENTATION



LEM-1
1-call Master



LE-A
Desktop/wall
mount sub station



LE-AN
Desktop/wall
mount sub station
w/privacy



LE-D
Door station,
surface mount,
ABS



LE-DA
Door station, sealed,
flush mount,
stainless steel



PS-0602DM
Power supply

WIRING

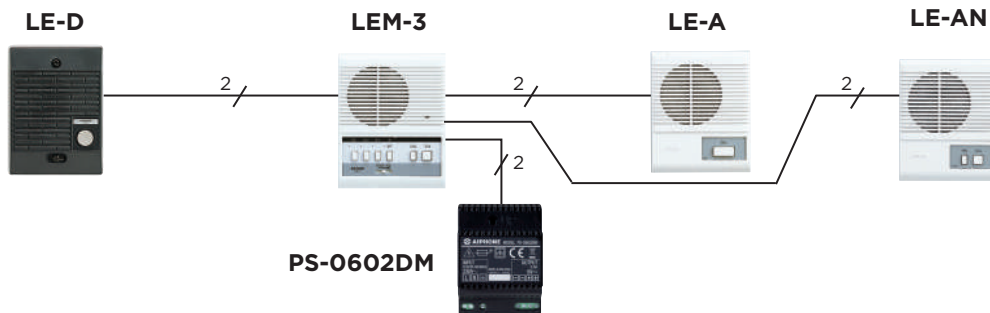

DIMENSIONS (mm)

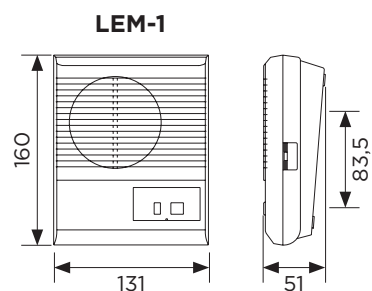
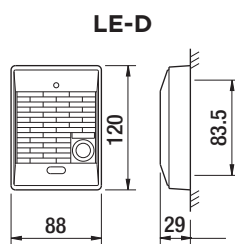
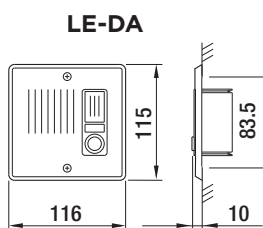

LEF SERIES

THE "PLUS"

- Possibility to install 5 door stations instead of sub station with lock release (RY-PA relays required)
- Opening doors with master stations only
- Mixed configuration possible: door stations + master + sub stations
- Hands-free conversation of called sub station
- All-call with LEF-10S (+ BG-10C required)
- Call by chime or voice
- Desktop or wall installation

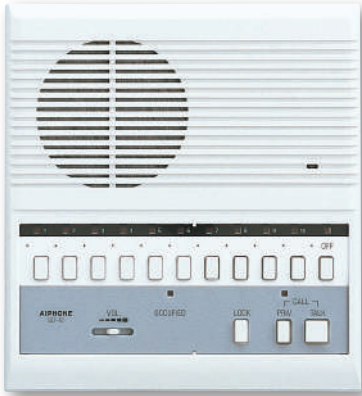

LEF-10
10-call Master

SERIES PRESENTATION

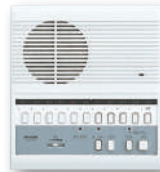

LE-A
Desktop/wall
mount sub station



LEF-10S
10-call master with
ALL CALL button



LEF-5
5-call Master



LE-D
Door station,
surface mount,
ABS



LE-DA
Door station, sealed,
flush mount,
stainless steel



AMP-LE/S
Call Point for LEF and LEM System



WIRING

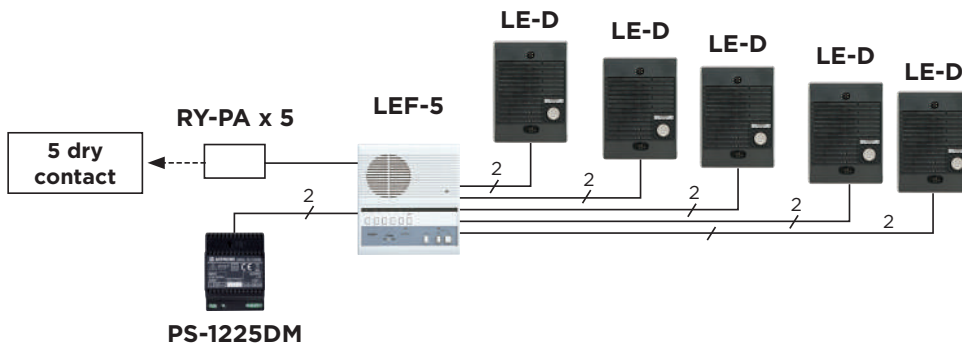

DIMENSIONS (mm)

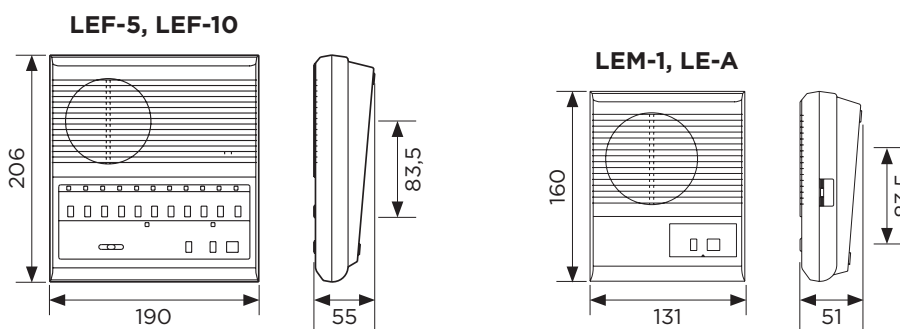

TDH SERIES

THE "PLUS"

- Possibility to put 2 door stations on the system
- Multi-channel: many people can speak at the same time
- 3-way conference
- Desktop or wall installation

SPECIFICATIONS

- **Power supply:** PS-1225DM
- **Wiring:** 1 common pair (+ 1 pair if door station)
+ 1 extra wire per handset
- **Total distance:** Room station 0,8 mm²: 1000 m DEUR
to the room station 0,8 mm²: 230 m

SERIES PRESENTATION



TD-6H/B
6-call master



TD-1H/B
1-call master



TD-3H/B
3-call master



TD-12H/B
12-call master



TD-24H/B
24-call master

DIMENSIONS (mm)

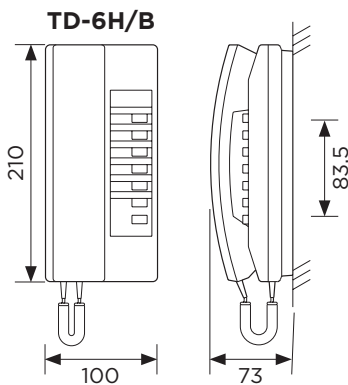

IE-JA
Door station, sealed,
flush mount,
stainless steel



IF-DA
Door station,
surface mount,
ABS



PS-1225DM
Power supply



DEUR
Door adaptor

WIRING

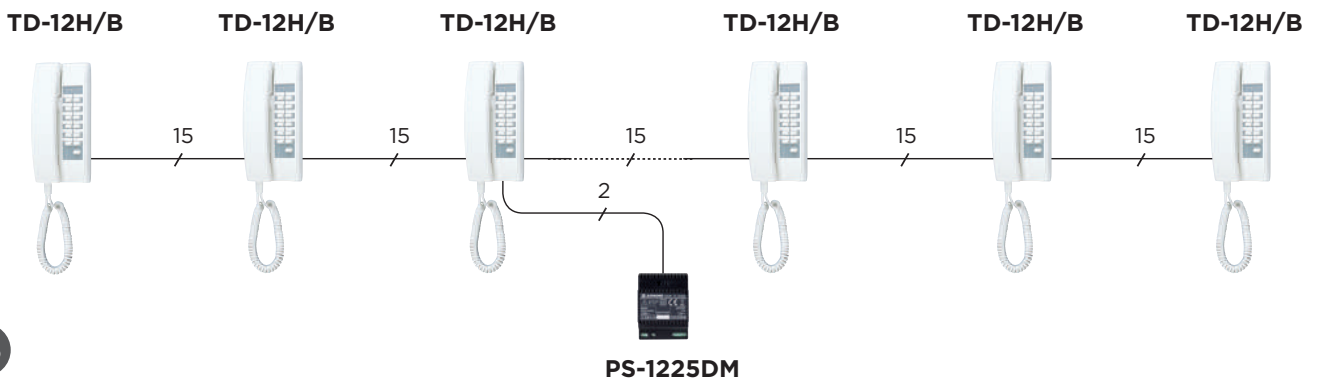

TCM SERIES

THE "PLUS"

- Large capacity: 60 room stations up to 2 masters
- Possibility to install up to 40 door stations in the system instead of sub stations (no door opening available)
- Desktop or wall installation
- Call transfer from one sub to another via master station

SPECIFICATIONS

- **Power supply:** PS-1820DM supplied with the master station
- **Wiring:** 2 non polarized wires per sub station
- **Total distance:** between master stations 0,8 mm²: 480 m
between master and sub 0,8 mm²: 900 m



TC-10M
10-call master

SERIES PRESENTATION

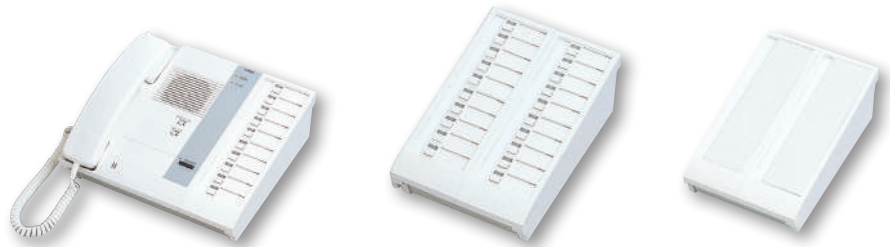

TC-20M
20-call master

TC-20G
20-call add-on selector

TB-AD10
10-door adaptor

DIMENSIONS (mm)

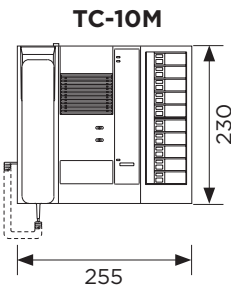
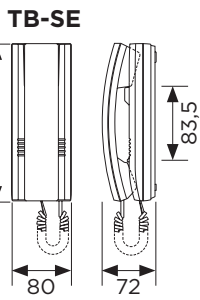
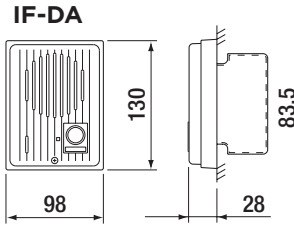

TC-40G
40-call add-on selector



TB-SE
Sub station



IF-DA
Door station,
surface mount,
ABS

WIRING

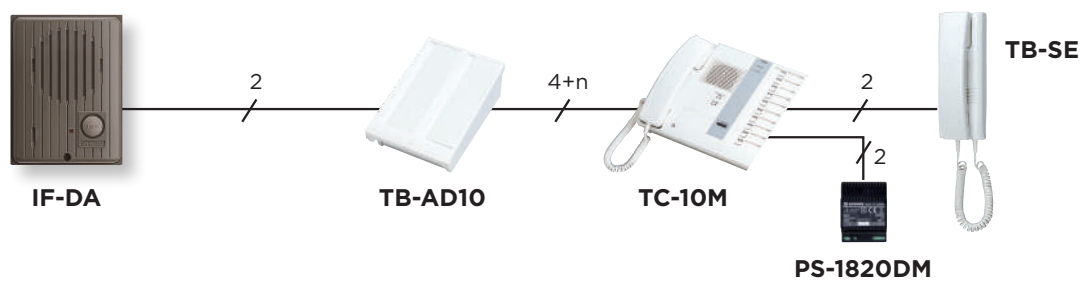

NIM SERIES

CAPACITY
1 MASTER > 40 SUB STATIONS

THE "PLUS"

- All Call
- Loud intercom
- Wide variety of sub stations
- Caller ID
- 20 to 40 calls

FEATURES

The **NIM system** can be used in a "nurse call" system and / or **intercom system**.

- Loud intercom in a noisy environment
- PC connection possible for call logging
- Door opening available
- Indication of the status of the call on the sub stations (call, answer in progress ...)
- All-call or selective announcement



NIM-20B
Master station, 20 call



NIM-40B
Master station, 40 call

SPECIFICATIONS

- 48 VDC power supply by IS-PUS
- Communication with handset or handsfree
- NI-SOFT PC software compatible with Windows 7 & 10
- Distance from master to sub 200 m ; 0,8 mm²

SERIES PRESENTATION



NI-BA
Sub station,
surface mount



NI-JA
Sub station,
flush mount



NI-LB
Ceiling speaker



NI-SB
Ceiling
microphone



NI-SOFT
Call log software
Accessory:
RS-232 cable



IS-PUS
Power supply

WIRING

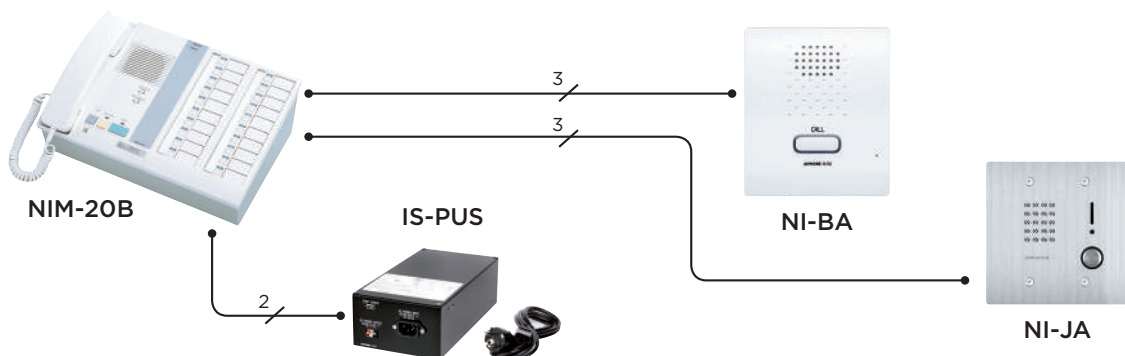



AIPHONE[®]
Providing Peace of Mind



Wireless video door bell with dect technology

WL11



www.aiphone.co.uk

Meet your Aiphone Sales Team

Harvey Williams
General Sales Manager
Mob: 07519125454
E-mail: harvey@aiphone.co.uk

Gavin Green
Scotland & Ireland Area Sales Manager
Mob: 07703529282
E-mail: gavin@aiphone.co.uk

Lynne Allen
Midlands & Northwest Area Sales Manager
Mob: 07703529288
E-mail: lynne@aiphone.co.uk

Adam Triggs
Southern Area Sales Manager
Mob: 07703529284
E-mail: adam@aiphone.co.uk

Aiphone UK Office
Unit 25 Mitre Bridge Industrial Estate
Mitre Way, White City,
London, W10 6AU

Tel: 020 7507 6250
Fax: 020 7691 7625
E-mail: enquiry@aiphone.co.uk

 **AIPHONE**®
Providing Peace of Mind



For more information on AIPHONE
solutions in the UK & Ireland visit:
www.aiphone.co.uk or call 0207 507 6250

**DOOR ENTRY
& INTERCOM SYSTEMS**